



## 29+ [Evidences](#) for Macroevolution

### The Scientific Case for Common Descent

Version 2.85

Copyright © 1999-2004 by [Douglas Theobald, Ph.D.](#)

[Last Update: undefined NaN, NaN]

***Permission is granted to copy and print these pages in total for non-profit personal, educational, research, or critical purposes.***

## Introduction

**E**volution, the overarching concept that unifies the biological sciences, in fact embraces a plurality of theories and hypotheses. In evolutionary debates one is apt to hear evolution roughly parceled between the terms "microevolution" and "macroevolution". Microevolution, or change beneath the species level, may be thought of as relatively small scale change in the functional and genetic constituencies of populations of organisms. That this occurs and has been observed is generally undisputed by critics of evolution. What is vigorously challenged, however, is [macroevolution](#). Macroevolution is evolution on the "grand scale" resulting in the origin of higher taxa. In evolutionary theory it thus entails common ancestry, descent with modification, the genealogical relatedness of all life, transformation of species, and large scale functional and structural changes of populations through time, all above the species level ([Freeman and Herron 2004](#); [Futuyma 1998](#); [Ridley 1993](#)).

Common descent is a general descriptive theory that concerns the genetic origins of living organisms (though not the ultimate origin of life). The theory specifically postulates that all of the earth's known biota are genealogically related, much in the same way that siblings or cousins are related to one another. Thus, macroevolutionary history and processes necessarily entail the transformation of one species into another and, consequently, the origin of higher taxa. Because it is so well supported scientifically, common descent is often called the "[fact of evolution](#)" by biologists. For these reasons, proponents of special creation are especially hostile to the macroevolutionary foundation of the biological sciences.

This article directly addresses the scientific evidence in favor of common descent and macroevolution. This article is specifically intended for those who are scientifically minded but, for one reason or another, have come to believe that macroevolutionary theory explains little, makes few or no testable predictions, is unfalsifiable, or has not been scientifically demonstrated.

## Outline

<p><b><u>Introduction</u></b></p> <ul style="list-style-type: none"> <li>● <a href="#">Universal Common Descent Defined</a></li> <li>● <a href="#">Evidence for Common Descent is Independent of Mechanism</a></li> <li>● <a href="#">What Counts as Scientific Evidence</a></li> <li>● <a href="#">Other Explanations for the Biology</a></li> <li>● <a href="#">How to Cite This Document</a></li> </ul> <p><a href="#">Scientific Evidence and the Scientific Method</a></p> <p><b><u>Phylogenetics introduction</u></b></p> <ul style="list-style-type: none"> <li>● <a href="#">Figure 1: A consensus universal phylogeny</a></li> <li>● <a href="#">Cladistics and phylogenetic reconstruction</a> <ul style="list-style-type: none"> <li>○ <a href="#">Maximum</a></li> </ul> </li> </ul>	<p><b><u>Part I. A unique, historical phylogenetic tree</u></b></p> <ol style="list-style-type: none"> <li>1. <a href="#">Unity of life</a></li> <li>2. <a href="#">Nested hierarchies</a></li> <li>3. <a href="#">Convergence of independent phylogenies</a> <ul style="list-style-type: none"> <li>○ <a href="#">Statistics of incongruent phylogenies</a></li> </ul> </li> <li>4. <a href="#">Transitional forms</a> <ul style="list-style-type: none"> <li>○ <a href="#">Reptile-birds</a></li> <li>○ <a href="#">Reptile-mammals</a></li> <li>○ <a href="#">Ape-humans</a></li> <li>○ <a href="#">Legged whales</a></li> <li>○ <a href="#">Legged seacows</a></li> </ul> </li> <li>5. <a href="#">Chronology of common ancestors</a></li> </ol>	<p><b><u>Part 2. Past history</u></b></p> <ol style="list-style-type: none"> <li>1. <a href="#">Anatomical vestiges</a></li> <li>2. <a href="#">Atavisms</a> <ul style="list-style-type: none"> <li>○ <a href="#">Whales with hindlimbs</a></li> <li>○ <a href="#">Humans tails</a></li> </ul> </li> <li>3. <a href="#">Molecular vestiges</a></li> <li>4. <a href="#">Ontogeny and developmental biology</a> <ul style="list-style-type: none"> <li>○ <a href="#">Mammalian ear bones, reptilian jaws</a></li> <li>○ <a href="#">Pharyngeal pouches, branchial arches</a></li> <li>○ <a href="#">Snake embryos with legs</a></li> <li>○ <a href="#">Embryonic human tail</a></li> <li>○ <a href="#">Marsupial eggshell and caruncle</a></li> </ul> </li> <li>5. <a href="#">Present biogeography</a></li> <li>6. <a href="#">Past biogeography</a> <ul style="list-style-type: none"> <li>○ <a href="#">Marsupials</a></li> <li>○ <a href="#">Horses</a></li> <li>○ <a href="#">Apes and humans</a></li> </ul> </li> </ol>
--	--	---

<ul style="list-style-type: none"> <li>○ <a href="#">parsimony</a></li> <li>○ <a href="#">Maximum likelihood</a></li> <li>○ <a href="#">Distance matrix methods</a></li> <li>● <a href="#">Statistical support for phylogenies</a></li> <li>● <a href="#">Does phylogenetic inference find correct trees?</a></li> <li>● <a href="#">Caveats with determining phylogenetic trees</a></li> </ul>		
<p><b><u>Part 3. Evolutionary opportunism</u></b></p> <ol style="list-style-type: none"> <li>1. <a href="#">Anatomical parahomology</a></li> <li>2. <a href="#">Molecular parahomology</a></li> <li>3. <a href="#">Anatomical convergence</a></li> <li>4. <a href="#">Molecular convergence</a></li> <li>5. <a href="#">Anatomical suboptimal function</a></li> <li>6. <a href="#">Molecular suboptimal function</a></li> </ol>	<p><b><u>Part 4. Molecular evidence</u></b></p> <ol style="list-style-type: none"> <li>1. <a href="#">Protein functional redundancy</a></li> <li>2. <a href="#">DNA functional redundancy</a></li> <li>3. <a href="#">Transposons</a></li> <li>4. <a href="#">Redundant pseudogenes</a></li> <li>5. <a href="#">Endogenous retroviruses</a></li> </ol>	<p><b><u>Part 5. Change</u></b></p> <ol style="list-style-type: none"> <li>1. <a href="#">Genetic</a></li> <li>2. <a href="#">Morphological</a></li> <li>3. <a href="#">Functional</a></li> <li>4. <a href="#">The strange past</a></li> <li>5. <a href="#">Stages of speciation</a></li> <li>6. <a href="#">Speciation events</a></li> <li>7. <a href="#">Morphological rates</a></li> <li>8. <a href="#">Genetic rates</a></li> </ol> <p><b><u>Closing remarks</u></b></p>

**What is Universal Common Descent?**

**U**niversal common descent is the hypothesis that all living, terrestrial organisms are genealogically related. All existing species originated gradually by biological, reproductive processes on a geological timescale. Modern organisms are the genetic descendants of one original [species](#) or communal gene pool. Genetical "gradualness", a much misunderstood term, is a mode of biological change that is dependent on population phenomena; it is not a statement about the rate or tempo of evolution. Truly genetically

**Other Links:**[A Critique of Douglas Theobald's "29 Evidences for Macroevolution"](#)

Lawyer, Churches of Christ minister, and young-earth creationist Ashby Camp argues that the evidence is insufficient to establish that all organisms share the same biological ancestor.

[Theobald Responds to Ashby Camp's "Critique"](#)

The author of this essay has written a response to Camp.

Search this FAQ

gradual events are changes within the range of biological variation expected between two consecutive generations. Morphological change may appear fast, geologically speaking, yet still be genetically gradual ([Darwin 1872](#), pp. 312-317; [Dawkins 1996](#), p.241; [Gould 2002](#), pp. 150-152; [Mayr 1991](#), pp. 42-47; [Rhodes 1983](#)). Though gradualness is not a mechanism of evolutionary change, it imposes severe constraints on possible macroevolutionary events. Likewise, the requirement of gradualness necessarily restricts the possible mechanisms of common descent and adaptation, briefly discussed below.

## Common Descent Can Be Tested Independently of Mechanistic Theories

In this essay, universal common descent alone is specifically considered and weighed against the scientific evidence. In general, separate "microevolutionary" theories are left unaddressed. Microevolutionary theories are gradualistic explanatory mechanisms that biologists use to account for the origin and evolution of macroevolutionary adaptations and variation. These mechanisms include such concepts as natural selection, [genetic drift](#), sexual selection, neutral evolution, and theories of speciation. The fundamentals of genetics, developmental biology, molecular biology, biochemistry, and geology are assumed to be fundamentally correct—especially those that do not directly purport to explain adaptation. However, whether microevolutionary theories are sufficient to account for macroevolutionary adaptations is a question that is left open.

Therefore, the evidence for common descent discussed here is independent of specific gradualistic explanatory mechanisms. None of the dozens of predictions directly address *how* macroevolution has occurred, how fins were able to develop into limbs, how the leopard got its spots, or how the vertebrate eye evolved. None of the evidence recounted here assumes that natural selection is valid. None of the evidence assumes that natural selection is sufficient for generating adaptations or the differences between species and other taxa. Because of this evidentiary independence, the validity of the macroevolutionary conclusion does not depend on whether natural selection, or the inheritance of acquired characters, or a *force vitale*, or something else is the true mechanism of adaptive evolutionary change. The scientific case for common descent stands, regardless.

Furthermore, because it is not part of evolutionary theory, [abiogenesis](#) also is not considered in this discussion of macroevolution: abiogenesis is an independent hypothesis. In evolutionary theory it is taken as axiomatic that an original self-replicating life form existed in the distant past, regardless of its origin. All scientific theories have their respective, specific explanatory domains; no scientific theory proposes to explain everything. Quantum mechanics does not explain the ultimate origin of particles and energy, even though nothing in that theory could work without particles and energy. Neither Newton's theory of universal gravitation nor the general theory of relativity attempt to explain the origin of matter or gravity, even though both theories would be meaningless without the *a priori* existence of gravity and matter. Similarly, universal common descent is restricted to the biological patterns found in the Earth's biota; it does not attempt to explain the ultimate origin of life.

## What is Meant by "[Scientific Evidence](#)" for Common Descent?

Scientific theories are validated by empirical testing against physical observations. Theories are not judged simply by their logical compatibility with the available data. Independent empirical testability is the hallmark of science—in science, an explanation must not only be compatible with the observed data, it must also be testable. By "testable" we mean that the hypothesis makes predictions about what observable evidence would be consistent and what would be incompatible with the hypothesis. Simple compatibility, in itself, is insufficient as scientific evidence, because all physical observations are consistent with an infinite number of unscientific conjectures. Furthermore, a scientific explanation must make risky predictions—the predictions should be necessary if the theory is correct, and few other theories should make the same necessary predictions.

As a clear example of an untestable, unscientific, hypothesis that is perfectly consistent with empirical observations, consider solipsism. The so-called hypothesis of solipsism holds that all of reality is the product of your mind. What experiments could be performed, what observations could be made, that could demonstrate that solipsism is wrong? Even though it is logically consistent with the data, solipsism cannot be tested by independent researchers. Any and all evidence is consistent with solipsism. Solipsism is unscientific precisely because no possible evidence could stand in contradiction to its predictions. For those interested, a brief explication of the [scientific method and scientific philosophy](#) has been included, such as what is meant by "scientific evidence", "falsification", and "testability".

In the following list of evidences, 30 major predictions of the hypothesis of common descent are enumerated and discussed. Under each point is a demonstration of how the prediction fares against actual biological testing. Each point lists a few examples of evolutionary confirmations followed by potential falsifications. Since one fundamental concept generates all of these predictions, most of them are interrelated. So that the logic will be easy to follow, related predictions are grouped into five separate subdivisions. Each subdivision has a paragraph or two introducing the main idea that unites the various predictions in that section. There are many in-text [references](#) given for each point. As will be seen, universal common descent makes many specific predictions about what should and what should not be observed

in the biological world, and it has fared very well against empirically-obtained observations from the past 140+ years of intense scientific investigation.

It must be stressed that this approach to demonstrating the scientific support for macroevolution is not a circular argument: the truth of macroevolution is not assumed *a priori* in this discussion. Simply put, the theory of universal common descent, combined with modern biological knowledge, is used to deduce predictions. These predictions are then compared to the real world in order see how the theory fairs in light of the observable evidence. In every example, it is quite possible that the predictions could be contradicted by the empirical evidence. In fact, if universal common descent were not accurate, it is highly probable that these predictions would fail. These empirically validated predictions present such strong evidence for common descent for precisely this reason. The few examples given for each prediction are meant to represent general trends. By no means do I purport to state all predictions or potential falsifications; there are many more out there for the inquiring soul to uncover.

## Are There Other Scientifically Valid Explanations?

The worldwide scientific research community from over the past 140 years has discovered that no known hypothesis other than universal common descent can account scientifically for the unity, diversity, and patterns of terrestrial life. This hypothesis has been verified and corroborated so extensively that it is currently accepted as fact by the overwhelming majority of professional researchers in the biological and geological sciences ([AAAS 1990](#); [NAS 2003](#); [NCSE 2003](#); [Working Group 2001](#)). No alternate explanations compete scientifically with common descent, primarily for four main reasons: (1) so many of the predictions of common descent have been confirmed from independent areas of science, (2) no significant contradictory evidence has yet been found, (3) competing possibilities have been contradicted by enormous amounts of scientific data, and (4) many other explanations are untestable, though they may be trivially consistent with biological data.

When evaluating the scientific evidence provided in the following pages, please consider alternate explanations. Most importantly, for each piece of evidence, critically consider what potential observations, if found, would be incompatible with a given alternate explanation. If none exist, that alternate explanation is not scientific. As explained above, a hypothesis that is simply compatible with certain empirical observations cannot use those observations as supporting scientific evidence.

## How to Cite This Document

Many people have asked how to cite this work in formal research papers and academic articles. This work is an online publication, published by the *Talk.Origins* archive. There are standard academic procedures for citing online publications. For example, if you last accessed this page on January 12, 2004, and used version 2.83, here is a reference in formal [MLA style](#):

Theobald, Douglas L. "29+ Evidences Macroevolution: The Scientific Case for Common

Descent." *The Talk.Origins Archive*. Vers. 2.83. 2004. 12 Jan, 2004 <<http://www.talkorigins.org/faqs/comdesc/>>

For more information about citing online sources, including [MLA](#), [APA](#), [Chicago](#), and [CBE](#) styles, see the formal style guidelines given in the book [Online!: a reference guide to using internet sources](#).

"... there are many reasons why you might not understand [an explanation of a scientific theory] ... Finally, there is this possibility: after I tell you something, you just can't believe it. You can't accept it. You don't like it. A little screen comes down and you don't listen anymore. I'm going to describe to you how Nature is - and if you don't like it, that's going to get in the way of your understanding it. It's a problem that [scientists] have learned to deal with: They've learned to realize that whether they like a theory or they don't like a theory is *not* the essential question. Rather, it is whether or not the theory gives predictions that agree with experiment. It is not a question of whether a theory is philosophically delightful, or easy to understand, or perfectly reasonable from the point of view of common sense. [A scientific theory] describes Nature as absurd from the point of view of common sense. And it agrees fully with experiment. So I hope you can accept Nature as She is - absurd.

I'm going to have fun telling you about this absurdity, because I find it delightful. Please don't turn yourself off because you can't believe Nature is so strange. Just hear me all out, and I hope you'll be as delighted as I am when we're through. "

- Richard P. Feynman (1918-1988),  
from the introductory lecture on quantum mechanics reproduced in *QED: The Strange Theory of Light and Matter* ([Feynman 1985](#)).



[Next](#)

## References

[American Association for the Advancement of Science](http://www.project2061.org/tools/sfaol/sfaatoc.htm) (1990) **Science for All Americans**. <http://www.project2061.org/tools/sfaol/sfaatoc.htm>

Darwin, C. (1872) **The Origin of Species**. Sixth Edition. The Modern Library, New York.

Dawkins, R. (1996) **The Blind Watchmaker**. New York, Norton.

Feynman, R. P. (1985) **QED: The Strange Theory of Light and Matter**. Princeton, NJ: Princeton University

Press.

Freeman, S. and Herron, J. C. (2004) **Evolutionary analysis** Third edition. Upper Saddle River, NJ: Pearson/Prentice Hall.

Futuyma, D. (1998) **Evolutionary Biology**. Third edition. Sunderland, MA: Sinauer Associates.

[Geological Society of America](http://www.geosociety.org/aboutus/position.htm) (2001) "Evolution." <http://www.geosociety.org/aboutus/position.htm>

Gould, S. J. (2002) **The Structure of Evolutionary Theory**. Cambridge, MA: Belknap Press of Harvard University Press.

Mayr, E. (1991) **One Long Argument**. Cambridge, Harvard University Press.

[National Academy of Sciences](http://www7.nationalacademies.org/evolution/nas.html). (2003) multiple statements. <http://www7.nationalacademies.org/evolution/nas.html>

[National Center for Science Education](http://www.ncseweb.org/resources/articles/3053_statements_from_scientific_and_12_19_2002.asp). (2003) "Voices for Evolution: Statements from Scientific and Scholarly Organizations."

A compilation of statements from 47 of the world's largest and most prestigious societies of professional research scientists, on the importance of evolutionary theory.

[http://www.ncseweb.org/resources/articles/3053\\_statements\\_from\\_scientific\\_and\\_12\\_19\\_2002.asp](http://www.ncseweb.org/resources/articles/3053_statements_from_scientific_and_12_19_2002.asp)

Rhodes, F. H. T. (1983) "Gradualism, punctuated equilibria, and the origin of species." *Nature* 305: 269-272.

Ridley, M. (1993) **Evolution**. Boston: Blackwell Scientific.

Working Group (2001) "Evolution, Science, and Society: Evolutionary biology and the national research agenda." *American Naturalist*. 158: S1. Endorsed by:

[American Institute of Biological Sciences](#),

[American Society of Naturalists](#),

[Animal Behavior Society](#),

[Ecological Society of America](#),

[Genetics Society of America](#),

[Paleontological Society](#),

[Society for Molecular Biology and Evolution](#),

[Society for the Study of Evolution](#), and

[Society of Systematic Biologists](#).

Full-text at <http://www.rci.rutgers.edu/~ecolevol/fulldoc.pdf> and <http://www.rci.rutgers.edu/~ecolevol/fulldoc.html>

## [Full References](#)

## [Glossary](#)

Access statistics of these pages counted using [WebCounter](#).

[pagerank](#)



  
[Next](#)

Home	Browse	Search	Feedback	Links
The FAQ		Must-Read Files		Index
Evolution		Creationism		Age of the Earth
Flood Geology		Catastrophism		Debates

[Home Page](#) | [Browse](#) | [Search](#) | [Feedback](#) | [Links](#)



[The FAQ](#) | [Must-Read Files](#) | [Index](#) | [Creationism](#) | [Evolution](#) | [Age of the Earth](#) |  
[Flood Geology](#) | [Catastrophism](#) | [Debates](#)

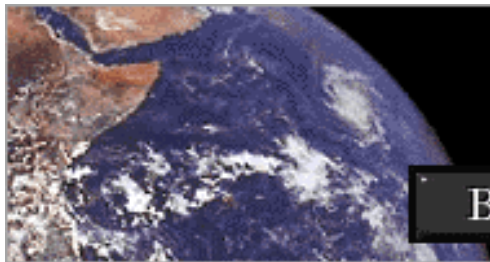

[Browse](#)[Search](#)[Feedback](#)[Links](#)

## 29+ Evidences for Macroevolution

### Scientific Proof?

Copyright © 1999-2003 by [Douglas Theobald, Ph.D.](#)

---



[Contents](#)

**W**hat is meant by scientific evidences and scientific proof? In truth, science can never establish "truth" or "fact" in the sense that a scientific statement can be made that is formally beyond question. All scientific statements and concepts are open to reevaluation as new data is acquired and novel technologies emerge. "Proof", then, is solely the realm of logic and mathematics. That said, we often hear "proof" mentioned in a scientific context, and there is a sense in which it denotes "strongly supported by scientific means". Even though one may hear "proof" used like this, it is a careless and inaccurate handling of the term. Consequently, except in reference to mathematics, this is the last time you will read the terms "proof" or "prove" in this article.

### Common Sense is Not Science

Though science formally cannot establish absolute truth, it can provide overwhelming evidence in favor of certain ideas. Often these ideas are quite unobvious, and usually they clash with common sense. Common sense tells us that the earth is flat, that the Sun truly rises and sets, that the surface of the Earth is not spinning at over 1000 miles per hour, that bowling balls fall faster than marbles, that particles don't curve around corners like waves around a floating dock, that the continents don't move, and that objects heavier-than-air can't have sustained flight unless they can flap wings. However, science has been used to demonstrate that all these common sense ideas are wrong.

### Science Provides Evidence for the Unobservable

The primary function of science is to demonstrate the existence of phenomena that cannot be observed directly. Science is not needed to show us things we can see with our own eyes. Direct observation is not only unnecessary in science; direct observation is in fact usually impossible for things that really matter. For example, the most important discoveries of science can only be *inferred* via indirect observation, including such things as atoms, electrons, viruses, bacteria, germs, radiowaves, X-rays, ultraviolet light, energy, entropy, enthalpy, solar fusion, genes, protein enzymes, and the DNA double-helix. The round earth was not observed directly by humans until 1961, yet this counterintuitive concept had been considered a scientific fact for over 2000 years. The Copernican hypothesis that the earth orbits the sun has been acknowledged virtually ever since the time of Galileo, though no one has ever observed the process to this day and in spite of the fact that direct observation indicates the very opposite. All of these "invisible" inferences were elucidated using the scientific method. When the term "evidence" is used in this article, it is used strictly in the context of this scientific method.

## The Scientific Method: More than Mere Experimentation

What is the scientific method? This is a complex and contentious question, and the field of inquiry known as the philosophy of science is committed to illuminating the nature of the scientific method. Probably the most influential philosopher of science of the 20th century was [Sir Karl Popper](#). Other notables are Thomas Kuhn, Imre Lakatos, Paul Feyerabend, Paul Kitcher, A. F. Chalmers, Wesley Salmon and Bas C. van Fraassen. This is not the place to delve into an explication of the various philosophies represented by these scholars; for more information I refer you to their works and to the discussion presented by John Wilkins in his [Evolution and Philosophy FAQ](#). I personally take an experimentalist and comparative Bayesian view of the scientific method ([Salmon 1990](#); [Mayo 1996](#)), and this will come through in how I present the evidence for common descent.

Now, to answer the question "What is the scientific method?" - very simply (and somewhat naively), the scientific method is a program for research which comprises four main steps. In practice these steps follow more of a logical order than a chronological one:

1. Make observations.
2. Form a testable, unifying hypothesis to explain these observations.
3. Deduce predictions from the hypothesis.
4. Search for confirmations of the predictions;  
if the predictions are contradicted by empirical observation, go back to step (2).

Because scientists are constantly making new observations and testing via those observations, the four "steps" are actually practiced concurrently. New observations, although they were not predicted, should be explicable retrospectively by the hypothesis.

New information, especially details of some process previously not understood, can impose new limits on the original hypothesis. Therefore, new information, in combination with an old hypothesis, frequently leads to novel predictions that can be tested further.

Examination of the scientific method reveals that science involves much more than naive empiricism. Research that only involves simple observation, repetition, and measurement is not sufficient to count as science. These three techniques are merely part of the process of making observations (#1 in the steps outlined above). Astrologers, wiccans, alchemists, and shamans all observe, repeat, and measure—but they do not practice science. Clearly, what distinguishes science is the way in which observations are interpreted, tested, and used.

## The Testable Hypothesis

The defining characteristic of science is the concept of the testable hypothesis. A testable hypothesis must make predictions that can be validated by independent observers. By "testable", we mean the predictions must include examples of what *should* be observed if the hypothesis is true and of what *should not* be observed if the hypothesis is true. A hypothesis that can explain all possible observations and data is not testable nor is it scientific. A good scientific hypothesis must rule out some conceivable possibilities, at least in principle. Furthermore, a scientific explanation must make risky predictions—the predictions should be necessary if the theory is correct, and few other theories should make the same necessary predictions. These scientific requirements are the essence of Popperian falsifiability and corroboration.

For instance, the solipsistic hypothesis that the entire universe is actually an elaborate figment of your imagination is not a scientific hypothesis. Solipsism makes no specific or risky predictions, it simply predicts that things will be "as they are". No possible observations could conflict with solipsism, since all observations always may be explained away as simply another detailed creation of your imagination. Many other extreme examples can be thought of, such as the hypothesis that the universe suddenly came into existence *in toto* five minutes ago, with even our memories of "earlier" events intact. In general, creationist and "intelligent design" conjectures fail scientifically for these same reasons, since both can easily explain all possible biological observations, and since both make no risky, specific predictions.

In contrast, Newton's scientific theory of universal gravitation predicts that the force between two masses should be inversely proportional to the square of the distance between them (otherwise known as the "inverse square law"). In principle, we could take measurements which indicated that the force is actually inversely proportional to the cube of the distance. Such an observation would be inconsistent with the predictions of Newton's universal theory of gravitation, and thus this theory is falsifiable. Anti-evolutionists, such as the "scientific" creationists, are especially fond of Karl Popper and

his falsifiability criterion, and they are well known for claiming that evolutionary theory is unscientific because it cannot be falsified. In this article, these accusations are met head on. Each of the evidences given for common descent contains a section providing examples of potential falsifications, i.e. examples of observations that are predicted *not* to be observed if the theory is correct.

## Degrees of Testability: Hypotheses, Theories, Facts

"Testability" is not an either-or concept; some hypotheses are more testable than others. Contrary to some anti-evolutionist claims, not all hypotheses are equally valid scientific "interpretations" of the evidence. Some hypotheses are more successful in terms of the scientific method. Based on the scientific method, a hypothesis that simply and elegantly explains the observed facts, that predicts many previously unobserved phenomena, and that withstands many potential falsifications is considered a valid and useful hypothesis. From a Bayesian perspective and according to Popper's corroboration measure, the best hypothesis available is the one that explains the most facts with the fewest assumptions, the one that makes the most confirmed predictions, and the one that is most open to testing and falsification.

In scientific practice, a superior and well-supported hypothesis will be regarded as a theory. A theory that has withstood the test of time and the collection of new data is about as close as we can get to a scientific fact. An example is the aforementioned notion of a heliocentric solar system. At one time it was a mere hypothesis. Although it is still formally just a well-supported theory, validated by many independent lines of evidence, it is now widely regarded as scientific "fact". Nobody has ever directly observed an electron, stellar fusion, radiowaves, entropy, or the earth circling the Sun, yet these are all scientific facts. As Stephen J. Gould has said, a scientific fact is not "absolute certainty", but simply a theory that has been "confirmed to such a degree that it would be perverse to withhold provisional consent".

## Testing Involves a Totality of Evidence and Statistics

The validity of a hypothesis does not stand or fall based on just a few confirmations or contradictions, but on the totality of the evidence. Often, data that initially may seem to be inconsistent with a theory will in fact lead to new important predictions. The history of Newtonian physics gives a clear example. The abnormal movement of Uranus was initially considered a potential falsification of Newton's new theory. However, by claiming the existence of an unseen planet, the anomaly was explained within Newton's paradigm. In general, an explanation for anomalous behavior should be considered *ad hoc* unless it is independently verifiable. Positing a new, unseen planet might be considered hedging if there were no independent way to detect if a new planet actually existed. Nevertheless, when technology had advanced enough to reliably test the new prediction, the unseen planet was found to be Neptune.

The lesson to be learned is that alternate explanations for "anomalies" should be treated like any other hypotheses: they should be weighed, tested, and either ruled out or confirmed. But a hypothesis should not be considered falsified until thorough testing has produced multiple lines of positive evidence indicating that the hypothesis is truly inconsistent with the empirical data.

A crucial related point is that modern scientific theories are probabilistic. This means that all testing of scientific predictions is carried out in a [statistical framework](#). Probability and statistics pervade modern scientific theories, including thermodynamics (statistical mechanics), geology, quantum mechanics, genetics, and medicine. The mathematics of probability is a discipline that many people find, shall we say, distasteful. However, a working knowledge of statistics is absolutely essential for judging the fit between observed data and the predictions of any theory.



## References

Chalmers, A. F. (1982) **What is this thing called Science?** Queensland, Australia, University of Queensland Press.

Stephen J. Gould (1981) "Evolution as Fact and Theory." Discover. May issue.

Kuhn, T. (1970) **The Structure of Scientific Revolutions.**

Lakatos, I. (1974) "Falsification and the Methodology of Scientific Research Programmes." **Criticism and the Growth of Knowledge.** I. Lakatos and A. Musgrave. Cambridge, Cambridge University Press: 91-196.

Mayo, D. (1996) **Error and the Growth of Experimental Knowledge.** Chicago, University of Chicago Press.

Popper, K. R. (1968) **The Logic of Scientific Discovery.** London, Hutchinson.

Salmon, W. (1990) "Rationality and Objectivity in Science, or Tom Kuhn meets Tom Bayes." **Scientific Theories.** C. W. Savage. Minneapolis, University of Minnesota Press. 14.

von Fraassen, B. C. (1980) **The Scientific Image.** Oxford, Clarendon Press.



[Contents](#)

<a href="#">Home</a>	<a href="#">Browse</a>	<a href="#">Search</a>	<a href="#">Feedback</a>	<a href="#">Links</a>
<a href="#">The FAQ</a>	<a href="#">Must-Read Files</a>		<a href="#">Index</a>	
<a href="#">Evolution</a>	<a href="#">Creationism</a>		<a href="#">Age of the Earth</a>	
<a href="#">Flood Geology</a>	<a href="#">Catastrophism</a>		<a href="#">Debates</a>	

[Home Page](#) | [Browse](#) | [Search](#) | [Feedback](#) | [Links](#)



[The FAQ](#) | [Must-Read Files](#) | [Index](#) | [Creationism](#) | [Evolution](#) | [Age of the Earth](#) | [Flood Geology](#) | [Catastrophism](#) | [Debates](#)

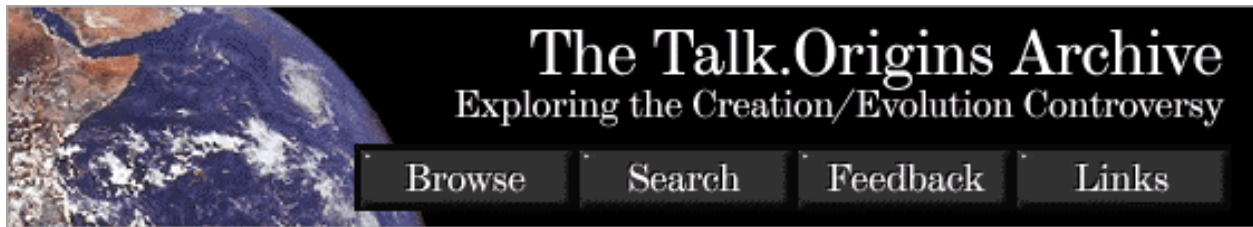

## 29+ Evidences for Macroevolution

### Phylogenetics Primer

Copyright © 1999-2004 by [Douglas Theobald, Ph.D.](#)



#### [Phylogenetics introduction](#)

- [Figure 1: A consensus universal phylogeny](#)
- [Phylogenetic trees](#)
- [Cladistics and phylogenetic reconstruction](#)
  - [Maximum parsimony](#)
  - [Maximum likelihood](#)
  - [Distance matrix methods](#)
- [Statistical support for phylogenies](#)
- [Does phylogenetic inference find correct trees?](#)
- [Caveats with determining phylogenetic trees](#)

#### Introduction to Phylogenetics

**D**escent from a common ancestor entails a process of branching and divergence of species, in common with any genealogical process. Genealogies can be graphically illustrated by tree-like diagrams, and this is why you will hear biologists refer to the genealogy of species as the "tree of life". Diagrams such as these are known as phylogenetic trees or phylogenies. The consensus model which evolutionary biologists use to represent the well-supported branches of the universal tree of life I will refer to as the "standard phylogenetic tree". [Figure 1](#) shows a simplified example of some of the more familiar branches of the universal phylogenetic tree. The macroevolutionary prediction of a unique, historical universal phylogenetic tree is the most important, powerful, and basic conclusion from the hypothesis of universal common descent. A thorough grasp of this concept is necessary for understanding macroevolutionary deductions.

In the following section is a brief overview of phylogenetic trees and of how biologists determine them. This overview becomes increasingly technical as it proceeds. The material up until the [maximum parsimony](#) heading is essential for understanding the rest of this FAQ. The remaining phylogenetic



discussion is given for completeness and to allow the interested reader the opportunity to delve as far as is desired.

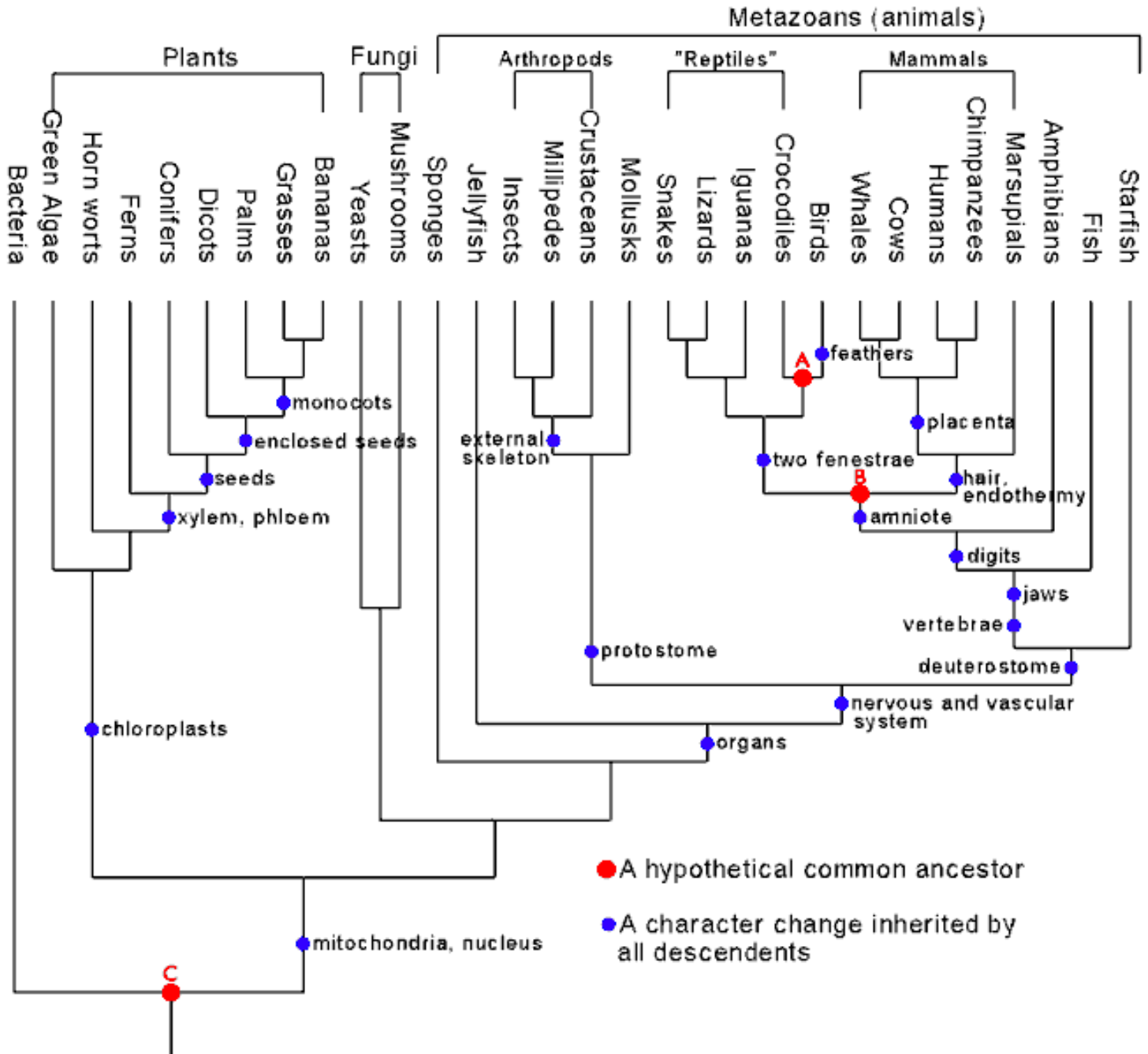

Figure 1. The Consensus Phylogenetic Tree of All Life.

## Phylogenetic trees represent evolutionary relationships

Phylogenetics is the scientific discipline concerned with describing and reconstructing the patterns of genetic relationships among species and among higher taxa. Phylogenetic trees are a convenient way of visually representing the evolutionary history of life. These diagrams illustrate the inferred relationships between organisms and the order of speciation events that led from earlier common ancestors to their diversified descendants.

A phylogenetic tree has several parts, shown in [Figure 2](#). *Nodes* represent taxonomic units, such as an organism, a species, a population, a common ancestor, or even an entire genus or other higher taxonomic

group. *Branches* connect nodes uniquely and represent genetic relationships. The specific pattern of branching determines the tree's *topology*. *Scaled* trees have branch lengths that are proportional to some important biological property, such as the number of amino acid changes between nodes on a protein phylogeny (see [Figure 3](#)). Trees may also be *rooted* or *unrooted*. Rooted trees have a special node, known as the *root*, that represents a common ancestor of all taxa shown in the tree. Rooted trees are thus directional, since all taxa evolved from the root. Unrooted trees illustrate relationships only, without reference to common ancestors.

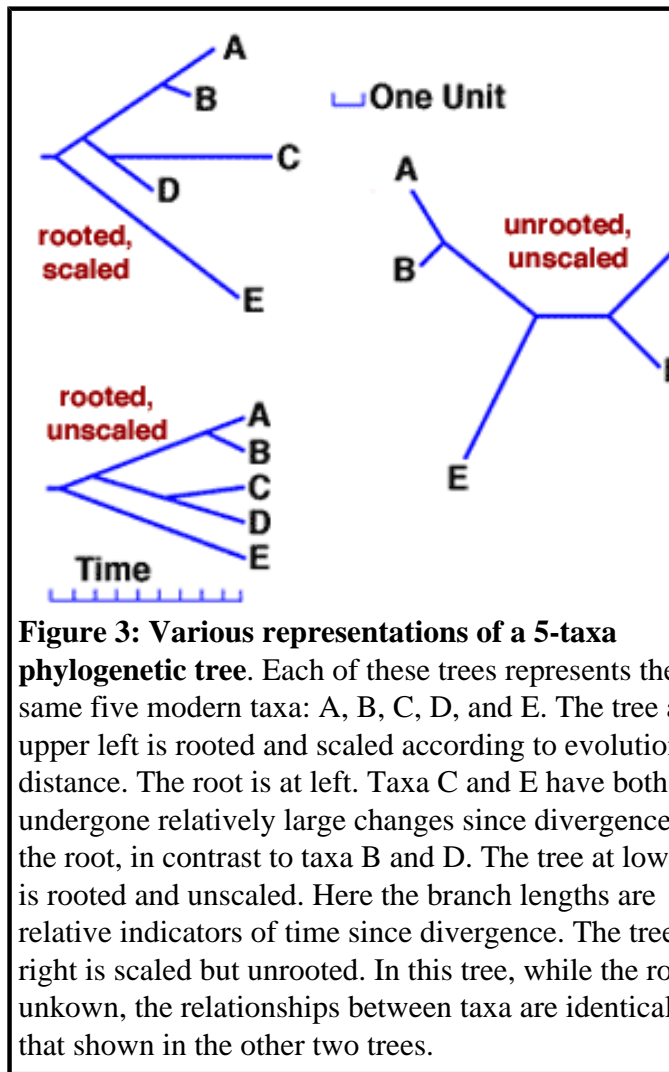

**Figure 3: Various representations of a 5-taxon phylogenetic tree.** Each of these trees represents the same five modern taxa: A, B, C, D, and E. The tree at upper left is rooted and scaled according to evolutionary distance. The root is at left. Taxa C and E have both undergone relatively large changes since divergence from the root, in contrast to taxa B and D. The tree at lower left is rooted and unscaled. Here the branch lengths are relative indicators of time since divergence. The tree at right is scaled but unrooted. In this tree, while the root is unknown, the relationships between taxa are identical to that shown in the other two trees.

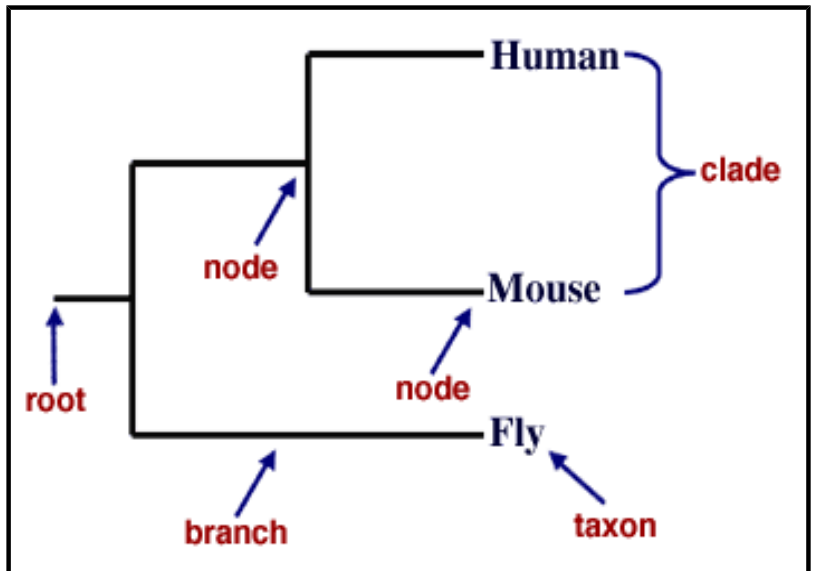

**Figure 2: The parts of a phylogenetic tree.** The taxa in this tree are "human", "mouse", and "fly" (all of which have had full genomes sequenced). Several nodes are indicated, as the "fly" taxon node and an internal node that represents the common ancestor of mice and humans. The root is indicated at left, representing the common ancestor of all three taxa listed.

A common misconception is that some modern species are ancestral to other modern species. However, all modern species are found at the tips of the tree's branches, and one modern species is as "evolved" as any other. That is, although mammals are thought to have evolved from something that resembled modern reptiles, modern reptiles are just as "old" evolutionarily as modern mammals ([Brooks 1991](#), p.68; [Futuyma 1998](#), p.113).

### Methods for determining phylogenetic trees: Cladistics and numerical phylogenetics

*Of all clean birds ye shall eat.  
But these are they of which ye shall not eat:*

*The eagle, and the ossifrage, and the ospray,  
And the glede, and the kite, and the vulture  
after his kind,  
And every raven after his kind,  
And the owl, and the night hawk, and the  
cuckow, and the hawk after his kind,  
The little owl, and the great owl, and the  
swan,  
And the pelican, and the gier eagle, and the  
cormorant,  
And the stork, and the heron after her kind,  
and the lapwing,*

and the bat.

Deuteronomy 14:11-18, KJV

If modern species have descended from ancestral ones in this tree-like, branching manner, it should be possible to infer the true historical tree that traces their paths of descent. Phylogenies have been inferred by biologists ever since Darwin first proposed that life was united by common descent over 140 years ago. Rigorous algorithmic methodologies for inferring phylogenetic trees have been in use for over the past 50 years.

In 1950, taxonomist [Willi Hennig](#) proposed a method for determining phylogenetic trees based on morphology by classifying organisms according to their shared derived characters, which are called *synapomorphies* ([Hennig 1966](#)). This method, now called *cladistics*, does not assume genealogical relatedness *a priori*, since it can be used to classify anything in principle, even things like books, cars, or chairs that are obviously not genealogically related in a biological sense ([Kitching et al. 1998](#), Ch. 1, p. 26; ). Using firm evolutionary arguments, however, Hennig justified this method as the most appropriate classification technique for estimating evolutionary relationships generated by lineal descent. In fact, Hennig's cladistic method is nothing more than a formalization of the methods systematic biologists had been using intuitively ever since Linnaeus penned *Systema Naturae*. Biologists today construct their phylogenetic trees based on Hennig's method, and because of cladistics these phylogenetic trees are reproducible and independently testable ([Brooks 1991](#), Ch. 2; [Kitching et al. 1998](#)).

#### Phylogenetic Jargon

**apomorphy:** A derived character of a group of organisms, not shared with ancestors of a group of organisms. Apomorphies are unique to the group, and are therefore group-defining.

**bootstrap:** A technical statistical procedure for estimating the variability of a measurement. In phylogenetics, bootstrapping involves the production of a new, pseudo-dataset by randomly pulling data points from the original dataset. For each pseudo-dataset, a new phylogeny is inferred. Rounds of this provide an estimation of the well- and poorly-supported regions of the original phylogeny.

**character:** An observable feature of an organism useful for distinguishing it from another. For example, a nucleotide in a DNA sequence, an amino acid in a protein sequence, or morphological characters like hair, feathers, or the presence or absence of certain bones.

**cladistics:** A class of phylogenetic techniques that construct trees (*cladograms*) by grouping taxa into nested hierarchies according to shared derived characters (*synapomorphies*). Cladistics is closely associated with the *parsimony* criterion.

**cladogram:** A hierarchical classification of taxa represented as a tree. Cladograms formally are independent of evolutionary theory, though in practice they are usually interpreted as phylogenies.

**derived character:** See [apomorphy](#).

**least squares:** A phylogenetic distance matrix criterion. The best tree is the one with the smallest squared difference between the observed pairwise distances and the distances calculated from the inferred tree. It has a strong statistical justification, as it is based upon the common [linear least squares](#) statistical technique. Least squares is guaranteed by the [Gauss-Markov theorem](#) to converge on the correct answer as more data is included in the analysis if a proper distance metric is used, i.e. least squares is statistically consistent. Weighted versions correct for random variability and bias due to longer branch lengths.

**maximum likelihood:** A cladistic criterion for inferring trees with character conflict. The best tree and evolutionary model maximize the probability of the observed data. Maximum likelihood has a strong statistical foundation. Given a correct model of evolutionary change, it is guaranteed to be statistically consistent, i.e. it will converge on the correct tree as more data is added. Maximum likelihood generally performs the best of all methods in simulations, but it is very computationally expensive. Unlike parsimony, it explicitly relies upon a specific evolutionary model.

**minimum evolution:** A phylogenetic distance matrix criterion. The best tree is the one in which the sum of the branch lengths is smallest.

**neighbor-joining:** A distance matrix algorithm for inferring trees. It is an approximation to the least-squares and minimum evolution methods.

**node:** A point in a phylogeny where branches meet or end. Nodes at the tip or end of a branch represent taxa. In rooted trees, internal nodes represent common ancestors.

**parsimony:** A phylogenetic criterion for inferring trees with character conflict. Parsimony requires that the best tree is the one with the least character conflict. It is known to produce the incorrect phylogeny in certain cases, such as when evolutionary rates are high or certain branches are long.

**phenetics:** Sometimes known as numerical taxonomy, phenetic methods classify and group organisms based on overall similarity, usually without explicit reference to their phylogenetic relationships.

**phylogeny:** A branching, tree-like diagram representing genealogical relationships among taxa. Rooted phylogenies specify common ancestors and have a time axis.

**plesiomorphy:** A primitive character, shared with the ancestors of a group of organisms. Since it is common to more than just the group being considered, a plesiomorphy is not group-defining.

**primitive character:** See [plesiomorphy](#).

**root:** A common ancestor of all taxa in a phylogeny. Chronologically, the root is the oldest node.

**synapomorphy:** A derived character that is shared between two groups of organisms.

**UPGMA:** A distance matrix-based clustering method for constructing trees. Rarely used, it is very fast but assumes constant evolutionary rates throughout the tree (a property called *ultrametricity*).

Cladistic methods are often contrasted with "phenetic" methods. Phenetic methods cluster and classify species based upon the number of identical characters that they share, that is, based upon overall similarity. Such methods can run into trouble with organisms like dolphins and tuna, which have many superficial similarities. These organisms, however, are not closely related and should not be classified together if one expects classification to reflect phylogeny.

In contrast, cladistic-based phylogenies group taxa into nested hierarchies, and they are determined using only shared [derived](#) characters of organisms, not shared [primitive](#) characters ([Brooks 1991](#), pp. 35-36; [Kitcing et al. 1998](#), Ch. 1; [Maddison and Maddison 1992](#), p. 49). In technical phylogenetic jargon, primitive characters are called *plesiomorphies*, and derived characters are called *apomorphies*. In cladistics, related species are grouped together because they share derived characters (i.e., apomorphies) that originated in a common ancestor of the group, but were not present in other, earlier ancestors of the group. These shared, derived features are called *synapomorphies*. Primitive and derived are therefore relative terms, depending upon the specific group being considered. For example, backbones are primitive characters of vertebrates, while hair is a derived character particular to mammalian vertebrates. However, when considering mammals only, hair is primitive, whereas an opposable thumb is derived.

In real-life phylogenetic analyses, shared derived characters may be in conflict with other derived characters. Thus, objective methods are required for resolving this character conflict ([Kitching et al. 1998](#), Ch. 1; [Maddison and Maddison 1992](#), p. 49). For instance, wings are a derived character of birds and of bats. Based upon this character alone, the cladistic method would group bats and birds together, which is how the author of Deuteronomy grouped them in the Biblical quote above. However, other shared derived characters indicate that bats should be grouped with wingless mammals, and that birds should be grouped with wingless dinosaurs.

In the past 40 years, several algorithmic methods have been devised to resolve such instances of character conflict and to infer correct phylogenetic trees ([Felsenstein 2004](#), Ch. 10). The following sections outline some of the most successful of these methods. Each method attempts to infer a phylogeny from existing data, and each has its respective strengths and weaknesses. Years of empirical testing and simulation have shown that, in general, these different algorithms, each with very different underlying assumptions, converge on trees that are highly similar when judged statistically ([Li 1997](#), Chs 5 and 6; [Nei and Kumar 2000](#), Chs 6, 7, and 8).

### Maximum parsimony

One of the oldest, most basic, and most frequently used methods for character resolution is the *maximum parsimony* (MP) criterion ([Edwards and Cavalli-Sforza 1963](#); [Kitching et al. 1998](#)). The parsimony criterion mandates that the best tree describing the data is the tree that minimizes the amount of character conflict. For example, consider a dataset containing 10 shared derived characters that group bats with apes (rather than with birds), and with one character that groups bats with birds (rather than apes). According to the parsimony criterion, the tree giving the first grouping should be preferred.

Currently, parsimony is the method of choice for reconstructing morphological trees ([Kitching et al. 1998](#)). It is very fast computationally, and it can be robust to differences in evolutionary rate among characters. However, maximum parsimony consistently finds the correct phylogeny only when we expect character conflict to be low or evolution to proceed parsimoniously ([Felsenstein 2004](#), Ch. 9; [Kitching et al. 1998](#), p. 17). If rates of evolution are slow and branches are short, character conflict will be low and parsimony will work well ([Felsenstein 2004](#), Ch. 9; [Felsenstein 1981a](#); [Li 1997](#), p. 128). If character conflict is moderate or high in reality, then it is very unlikely that the true tree will have the least amount of character conflict. When rates of evolution are high, or when some branches are very long, or when the number of possible character states is limited, character conflict can be common. This is often true for nucleotide sequences, which have only four possible character states (A, C, T, or G). In cases such as these, other phylogenetic methods can be more accurate than parsimony.

### Maximum likelihood

Another commonly used phylogenetic criterion is *maximum likelihood* (ML), an effective and robust statistical technique now used in all scientific fields ([Edwards and Cavalli-Sforza 1964](#); [Felsenstein 1981b](#); [Fisher 1912](#)). Many well-known statistical estimators are actually *maximum likelihood* estimators. For example, the common sample average as an estimate of the mean of a Gaussian distribution and the least-squares fit of a line to a set of points are both maximum likelihood estimators. Using ML, one can infer rates of evolution directly from the data and determine the tree that best describes that data given those inferred rates. In other words, ML finds the tree and evolutionary parameters that maximize the probability of the observed data. Unlike parsimony, ML finds trees with the expected amount of character conflict given the evolutionary rates inferred from the data, even if those rates are high. ML is a computationally intensive method that can be very time-consuming.

## Distance methods

Due to their computational speed, distance matrix methods are some of the most popular for inferring phylogenies ([Nei and Kumar 2000](#), Ch. 6). All distance methods transform character data into a matrix of pairwise distances, one distance for each possible pairing of the taxa under study. Distance matrix methods are not cladistic, since the information about derived and primitive characters has been lost during this transformation. Distance methods approach phylogenetic inference strictly as a statistical problem, and they are used almost exclusively with molecular data. Although they are not cladistic, distance methods can be thought of as approximations to cladistic methods, and several of the methods are guaranteed mathematically to converge on the correct tree as more data is included.

The most simple distance metric is merely the number of character differences between two taxa, such as the number of nucleotide differences between two DNA sequences. Many other ways of calculating molecular sequence distances exist, and most attempt to correct for the possibility of multiple changes at a single site during evolution. Methods for calculating distances between sequences are usually named for their originators, such as Kimura's two-parameter (K2P), Jukes-Cantor (JC), Tamura-Nei (TN), Hasegawa, Kishino, and Yano (HKY), and Felsenstein 1984 (F84). Other important distance metrics are General Time Reversible (GTR) and LogDet ([Felsenstein 2004](#), pp. Chs 11 and 13; [Nei and Kumar 2000](#), Chs 2 and 3; [Li 1997](#), Chs 3 and 4).

Once a distance matrix for the taxa being considered is in hand, there are several distance-based criteria and algorithms that may be used to estimate the phylogenetic tree from the data ([Felsenstein 2004](#), Ch. 11; [Li 1997](#), Ch. 5). The *minimum evolution* (ME) criterion finds the tree in which the sum of all the branch lengths is the smallest. *Weighted and unweighted least squares* criteria calculate the discrepancy between the observed pairwise distances and the pairwise distances calculated from the branch lengths of the inferred tree. Least squares then finds the tree that minimizes the square of that discrepancy. Least squares methods are some of the most statistically justified and will converge on the correct tree as more data are included in the analysis (given a mathematically proper distance metric). The *neighbor-joining* (NJ) algorithm is extremely fast and is an approximation of the least squares and minimum evolution methods. If the distance matrix is an exact description of the true tree, then neighbor-joining is guaranteed to reconstruct the correct tree. The *UPGMA* clustering algorithm (a confusing acronym) is also extremely fast, but it is based upon the unlikely assumption that evolutionary rates are equal in all lineages. UPGMA is rarely used today except as an instructional tool.

## Statistical Support for Phylogenies

A phylogeny is a best approximation of the correct, historical tree using a given phylogenetic method. Some phylogenetic analyses are strongly supported by the data, some are weakly supported, and different parts of a tree may have more support than others. When comparing two independently determined phylogenies, one must take into account the statistical support assigned to each branch of the phylogenies. As with all scientific analyses, the details of a phylogenetic tree may change as new information and data are incorporated ([Maddison and Maddison 1992](#), pp. 112-123; [Li 1997](#), pp. 36-146; [Felsenstein 1985](#); [Futuyma 1998](#), p. 99; [Hillis and Bull 1993](#); [Huelsenbeck et al. 2001](#); [Swofford et al. 1996](#), pp. 504-509).

*Bootstrapping* is the most popular statistical method for assessing the reliability of the branches in a phylogenetic tree ([Felsenstein 1985](#)). Bootstrapping is a statistical technique for empirically estimating the variability of a parameter ([Efron 1979](#); [Efron and Gong 1983](#)). In a bootstrap analysis, a fictional dataset is created by randomly sampling data from the real dataset until a new dataset is created of the same size. This process is done repeatedly (hundreds or thousands of times), and the parameter of interest is

estimated from each fictional dataset. The variability of these bootstrapped estimations is itself an estimate of the variability of the parameter of interest.

In phylogenetics, a new phylogeny is inferred from each bootstrapped dataset ([Felsenstein 1985](#)). These bootstrapped phylogenies will likely have different topologies. From these different bootstrapped trees, the variability in the inferred tree can be estimated. The parts of the bootstrapped trees that are in common are ascribed a high confidence, while the parts that vary extensively are assigned a low confidence. Trees constructed from random data do not result in high confidence trees or branches when bootstrapped. Thus, bootstrapping provides one way to test whether a phylogenetic tree is genuine.

## Does Phylogenetic Inference Find Correct Trees?

In order to establish their validity in reliably determining phylogenies, phylogenetic methods have been empirically tested in cases where the true phylogeny is known with certainty, since the true phylogeny was directly observed.

- Bacteriophage T7 was propagated and split sequentially in the presence of a mutagen, where each lineage was tracked. Out of 135,135 possible phylogenetic trees, the true tree was correctly determined by phylogenetic methods in a blind analysis. Five different phylogenetic methods were used independently, and each one chose the correct tree ([Hillis et al.1992](#)).
- In another study, 24 strains of mice were used in which the genealogical relationships were known. Cladistic analysis reproduced almost perfectly the known phylogeny of the 24 strains ([Atchely and Fitch 1991](#)).
- [Bush et al.](#) used phylogenetic analysis to retrospectively predict the correct evolutionary tree of human Influenza A virus 83% of the time for the flu seasons spanning 1983 to 1994.
- In 1998, researchers used 111 modern HIV-1 (AIDS virus) sequences in a phylogenetic analysis to predict the nucleotide sequence of the viral ancestor of which they were all descendants. The predicted ancestor sequence closely matched, with high statistical probability, an actual ancestral HIV sequence found in an HIV-1 seropositive African plasma sample collected and archived in the Belgian Congo in 1959 ([Zhu et al.1998](#)).
- In the past decade, phylogenetic analyses have played a significant role in successful convictions in several criminal court cases ([Albert et al. 1994](#); [Arnold et al. 1995](#); [Birch et al. 2000](#); [Blanchard et al. 1998](#); [Goujon et al. 2000](#); [Holmes et al. 1993](#); [Machuca et al. 2001](#); [Ou et al. 1992](#); [Veenstra et al. 1995](#); [Vogel 1997](#); [Yirrell et al. 1997](#)), and phylogenetic reconstructions have now been admitted as expert legal testimony in the United States (97-KK- 2220 *State of Louisiana v. Richard J. Schmidt* [[PDF](#)]). The legal test in the U. S. for admissibility of expert testimony is the *Daubert* guidelines (U. S. Supreme Court Case [Daubert v. Merrell Dow Pharmaceuticals, Inc.](#), 509 U.S. 579, 587-89, 113 S. Ct. 2786, 2794, 125 L. Ed. 2d 469, 1993). The *Daubert* guidelines state that a trial court should consider five factors in determining "whether the testimony's underlying reasoning or methodology is scientifically valid": (1) whether the theory or technique in question can be and has been tested; (2) whether it has been subjected to peer review and publication; (3) its known or potential error rate; (4) the existence and maintenance of standards controlling its operation; and (5) whether it has attracted widespread acceptance within the relevant scientific community (quoted nearly verbatim). Phylogenetic analysis has officially met these legal requirements.

## Caveats with Phylogenetic Inference

As with any investigational scientific method, certain conditions must hold in order for the results to be reliable. A common premise of all molecular phylogenetic methods is that genes are transmitted via vertical, lineal inheritance, i.e. from ancestor to descendant. If this premise is violated, gene trees will never recapitulate an organismic phylogeny. This assumption is violated in instances of horizontal transfer, e.g. in transformation of a bacterium by a DNA plasmid, or in retroviral insertion into a host's genome. During the early evolution of life, before the advent of multicellular organisms, horizontal transfer was likely very frequent (as it is today in the observed evolution of bacteria and other unicellular organisms). Thus, it is questionable whether molecular methods are applicable, even in principle, to resolving the phylogeny of the early evolution of life near the most recent common ancestor of all living organisms ([Doolittle 1999](#); [Doolittle 2000](#); [Woese 1998](#)).

The list below gives some of the more important caveats that scientists must keep in mind when interpreting the results of a phylogenetic analysis ([Swofford 1996](#), pp. 493-509). In general, the contribution of each of these concerns will be "averaged out" by including more independent characters in the phylogenetic analysis, such as more genes and longer sequences.

- **Correlated characters:** each character used in the analysis optimally should be genetically independent. Characters that are strongly functionally correlated are better thought of as a single character. There are statistical tests that can help control for unrecognized character correlation, such as the block bootstrap and jackknife.
- **True structural convergence:** structures that have undergone convergent evolution can artificially result in incorrect tree topologies. Including more characters in the analysis also aids in overcoming convergent effects.
- **Character reversals:** characters that revert to an ancestral state pose a challenge similar to convergence. Because DNA and RNA only have four different character states, they are especially prone to reversals during evolution.
- **Lost characters:** lineages that have lost characters (such as whales and their hindlimbs) can also pose cladistic problems. Often, if a cladistic analysis indicates strongly that a certain character has been lost during evolution, it is best to omit this character in higher resolution analyses of that lineage.
- **Missing characters:** incomplete fossils are problematic, since they may lack important characters. Better fossils are the answer.
- **Intractable number of possible phylogenetic trees:** for computational reasons, this is one of the most important phylogenetic challenges to overcome. The goal of a phylogenetic reconstruction is to determine the best tree that the data supports. For an analysis of only five species, there are 15 possible trees. For an analysis of 50 species, there are over  $10^{74}$  possible trees that must be searched—which is computationally impossible. This problem is not as bad as it first sounds, since narrowing down the number of reasonable trees can be trivial in many cases (for instance, using the branch and bound algorithm). Several methods have been developed to work around this issue successfully, and ultimately more powerful computers are better.
- **Maximum Likelihood assumptions:** the *maximum likelihood* method makes explicit assumptions about the pattern of nucleotide substitutions based upon a given model of nucleotide



evolution. These assumptions are based upon a solid statistical foundation; however, the validity of the models must be considered when evaluating the results.

- **Long branch attraction:** lineages that diverged relatively long ago will tend to "cluster" together in a phylogenetic reconstruction under the appropriate conditions. The mathematical reasons are somewhat complicated, but using more slowly evolving genes (or regions of genes) helps overcome the problem.
- **Rate variation between lineages:** rates of nucleotide substitution may differ between lineages; this can contribute to long branch attraction and result in incorrect tree topologies. However, maximum likelihood and least squares methods are particularly useful here.
- **Rate variation within a single gene:** rates of nucleotide substitution can vary along the length of a single gene—this also exacerbates long branch attraction.
- **Gene trees are not equivalent to species trees:** from simple Mendelian genetics we know that genes segregate individually, and that throughout time individual genes do not necessarily follow organismic genealogy ([Avice and Wollenberg 1997](#); [Fitch 1970](#); [Hudson 1992](#); [Nichols 2001](#); [Wu 1991](#)). An obvious example is the fact that while you may have brown eyes, your child may have the genes for blue eyes—but that does not mean your child is not your descendent, or that your brown-eyed children are more closely related to you than your blue-eyed children. Including multiple genes in the analysis is a solution to this conundrum. Based upon simple genetic calculations, an analysis of more than five genes is usually necessary to accurately reconstruct a species phylogeny ([Wu 1991](#)).

For more information on cladistics, you can consult one of several excellent online cladistic resources, such as the [SASB Introduction to Phylogenetics](#), UC Berkeley's Integrative Biology [Phylogenetics Lab](#), or Diana Lipscomb's stellar [Basics of Cladistic Analysis](#), downloadable in [Adobe Acrobat PDF format](#). A good, concise description for the layperson can be found at the [Journal of Avocational Paleontology](#). Finally, you can read Charles Darwin's explanation in **The Origin of Species** of the "[Tree of Life](#)", where the concept of a phylogenetic tree was first introduced.

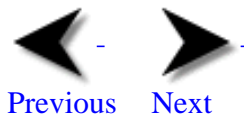

## References

- Albert, J., Wahlberg, J., Leitner, T., Escanilla, D. and Uhlen, M. (1994) "Analysis of a rape case by direct sequencing of the human immunodeficiency virus type 1 pol and gag genes." *J Virol* 68: 5918-24. [\[PubMed\]](#)
- Arnold, C., Balfe, P. and Clewley, J. P. (1995) "Sequence distances between env genes of HIV-1 from individuals infected from the same source: implications for the investigation of possible transmission events." *Virology* 211: 198-203. [\[PubMed\]](#)
- Atchely, W. R., and Fitch, W. M. (1991) "Gene trees and the origins of inbred strains of mice." *Science* 254: 554-558. [\[PubMed\]](#)
- Avice, J. C., and Wollenberg, K. (1997) "Phylogenetics and the origin of species." *PNAS* 94: 7748-7755. <http://www.pnas.org/cgi/content/full/94/15/7748>

Birch, C. J., McCaw, R. F., Bulach, D. M., Revill, P. A., Carter, J. T., Tomnay, J., Hatch, B., Middleton, T. V., Chibo, D., Catton, M. G., Pankhurst, J. L., Breschkin, A. M., Locarnini, S. A. and Bowden, D. S. (2000) "Molecular analysis of human immunodeficiency virus strains associated with a case of criminal transmission of the virus." *J Infect Dis* 182: 941-4. <http://www.journals.uchicago.edu/JID/journal/issues/v182n3/000154/000154.html>

Blanchard, A., Ferris, S., Chamaret, S., Guetard, D. and Montagnier, L. (1998) "Molecular evidence for nosocomial transmission of human immunodeficiency virus from a surgeon to one of his patients." *J Virol* 72: 4537-40. <http://jvi.asm.org/cgi/content/full/72/5/4537?view=full&pmid=9557756>

Brooks, D. R., and McLennan, D. A. (1991) **Phylogeny, ecology, and behavior**. Chicago: University of Chicago Press.

Bush, R. M., C. A. Bender, *et al.* (1999) "Predicting the evolution of human influenza A." *Science* 286: 1921-1925. [\[PubMed\]](#)

Doolittle, W. F. (1999) "Phylogenetic Classification and the Universal Tree." *Science* 284: 2124. [\[PubMed\]](#)

Doolittle, W. F. (2000) "The nature of the universal ancestor and the evolution of the proteome." *Current Opinion in Structural Biology* 10: 355-358. [\[PubMed\]](#)

Edwards, A. W. F. and Cavalli-Sforza, L. L. (1963) "The reconstruction of evolution." *Annals of Human Genetics* 27: 105-106.

Efron, B. (1979) "Bootstrap methods: Another look at the jackknife." *Annals of Statistics* 7: 1-26.

Efron, B. and Gong, G. (1983) "A leisurely look at the bootstrap, the jackknife, and cross validation." *American Statistician* 37: 36-48.

Edwards, A. W. F. and Cavalli-Sforza, L. L. (1964) "Reconstruction of phylogenetic trees." in **Phenetic and Phylogenetic Classification**. ed. Heywood, V. H. and McNeill. London: Systematics Assoc. Pub No. 6.

Felsenstein, J. (1981) "A likelihood approach to character weighting and what it tells us about parsimony and compatibility." *Biol J Linn Soc Lond* 16: 183-196.

Felsenstein, J. (1981) "Evolutionary trees from DNA sequences: A maximum likelihood approach." *J Mol Evol* 17: 368-376. [\[PubMed\]](#)

Felsenstein, J. (1985) "Confidence limits on phylogenies: an approach using the bootstrap." *Evolution* 39: 783-791.

Felsenstein, J. (2004) **Inferring Phylogenies**. Sunderland, MA: Sinauer Associates.

Fisher, R. A. (1912) "On an absolute criterion for fitting frequency curves." *Messenger of Mathematics* 41: 155-160.

Fitch, W. M. (1970) "Distinguishing homologous from analogous proteins." *Syst. Zool.* 28: 132-163.

Futuyma, D. (1998) **Evolutionary Biology**. Third edition. Sunderland, MA: Sinauer Associates.

Goujon, C. P., Schneider, V. M., Grofti, J., Montigny, J., Jeantils, V., Astagneau, P., Rozenbaum, W., Lot, F., Frocrain-Herchkovitch, C., Delphin, N., Le Gal, F., Nicolas, J. C., Milinkovitch, M. C. and Deny, P. (2000) "Phylogenetic analyses indicate an atypical nurse-to-patient transmission of human immunodeficiency virus type 1." *J Virol* 74: 2525-32. <http://jvi.asm.org/cgi/content/full/74/6/2525?view=full&pmid=10684266>

Hennig, W. (1966) **Phylogenetic Systematics**. (English Translation). Urbana: University of Illinois Press.

Hillis, D. M., and Bull, J. J. (1993) "An empirical test of bootstrapping as a method for assessing confidence on phylogenetic analysis." *Syst. Biol.* 42: 182-192.

Hillis, D. M., J. J. Bull, *et al.* (1992) "Experimental phylogenetics: Generation of a known phylogeny." *Science* 255: 589-592. [\[PubMed\]](#)

Holmes, E. C., Zhang, L. Q., Simmonds, P., Rogers, A. S. and Brown, A. J. (1993) "Molecular investigation of human immunodeficiency virus (HIV) infection in a patient of an HIV-infected surgeon." *J Infect Dis* 167: 1411-4. [\[PubMed\]](#)

Hudson, R. R. (1992) "Gene trees, species trees and the segregation of ancestral alleles." *Genetics* 131: 509-513. [\[PubMed\]](#)

Huelsenbeck, J. P., Ronquist, F., Nielsen, R., and Bollback, J. P. (2001) "Bayesian inference of phylogeny and its impact on evolutionary biology." *Science* 294: 2310-2314. [\[PubMed\]](#)

Kitching, I. J., Forey, P. L., Humphries, C. J., and Williams, D. M. (1998) **Cladistics: The Theory and Practice of Parsimony Analysis**. Second Edition. The Systematics Association Publication No. 11. Oxford: Oxford University Press.

Li, W.-H. (1997) **Molecular Evolution**. Sunderland, MA: Sinauer Associates.

Machuca, R., Jorgensen, L. B., Theilade, P. and Nielsen, C. (2001) "Molecular investigation of transmission of human immunodeficiency virus type 1 in a criminal case." *Clin Diagn Lab Immunol* 8: 884-90. [\[PubMed\]](#)

Maddison, W. P., and Maddison, D. R. (1992) **MacClade**. Sunderland, MA: Sinauer Associates.

Nei, M. and Kumar, S. (2000) **Molecular Evolution and Phylogenetics**. New York, NY: Oxford University Press.

Nichols, R. (2001) "Gene trees and species trees are not the same." *Trends Ecol Evol*. 16: 358-364. [\[PubMed\]](#)

Ou, C. Y., Ciesielski, C. A., Myers, G., Banda, C. I., Luo, C. C., Korber, B. T., Mullins, J. I., Schochetman, G., Berkelman, R. L., Economou, A. N. and *et al.* (1992) "Molecular epidemiology of HIV transmission in a dental practice." *Science* 256: 1165-71. [\[PubMed\]](#)

Swofford, D. L., Olsen, G. J., Waddell, P. J., and Hillis, D. M. (1996) "Phylogenetic inference." In **Molecular Systematics**, pp 407-514. Hillis, D. M., Moritz, C. and Mable, B. K. eds., Sunderland, Massachusetts: Sinauer.

Veenstra, J., Schuurman, R., Cornelissen, M., van't Wout, A. B., Boucher, C. A., Schuitemaker, H., Goudsmit, J. and Coutinho, R. A. (1995) "Transmission of zidovudine-resistant human immunodeficiency virus type 1 variants following deliberate injection of blood from a patient with AIDS: characteristics and natural history of the virus." *Clin Infect Dis* 21: 556-60. [\[PubMed\]](#)

Vogel, G. (1997) "Phylogenetic analysis: getting its day in court." *Science* 275: 1559-60. [\[PubMed\]](#)

Woese, C. (1998) "The universal ancestor." *PNAS* 95: 6854-6859. <http://www.pnas.org/cgi/content/full/95/12/6854>



Wu, C. I. (1991) "Inferences of species phylogeny in relation to segregation of ancient polymorphisms." *Genetics* 127: 429-435. [\[PubMed\]](#)

Yirrell, D. L., Robertson, P., Goldberg, D. J., McMenamin, J., Cameron, S. and Leigh Brown, A. J. (1997) "Molecular investigation into outbreak of HIV in a Scottish prison." *Bmj* 314: 1446-50. <http://bmj.com/cgi/content/full/314/7092/1446?view=full&pmid=9167560>

Zhu, T., B. Korber, *et al.* (1998) "An African HIV-1 sequence from 1959 and implications for the origin of the epidemic." *Nature* 391: 594-597. [\[PubMed\]](#)

[Full references](#)

[Glossary](#)

 [Previous](#)  [Next](#)

<a href="#">Home</a>	<a href="#">Browse</a>	<a href="#">Search</a>	<a href="#">Feedback</a>	<a href="#">Links</a>
<a href="#">The FAQ</a>		<a href="#">Must-Read Files</a>		<a href="#">Index</a>
<a href="#">Evolution</a>		<a href="#">Creationism</a>		<a href="#">Age of the Earth</a>
<a href="#">Flood Geology</a>		<a href="#">Catastrophism</a>		<a href="#">Debates</a>

[Home Page](#) | [Browse](#) | [Search](#) | [Feedback](#) | [Links](#)



[The FAQ](#) | [Must-Read Files](#) | [Index](#) | [Creationism](#) | [Evolution](#) | [Age of the Earth](#) | [Flood Geology](#) | [Catastrophism](#) | [Debates](#)

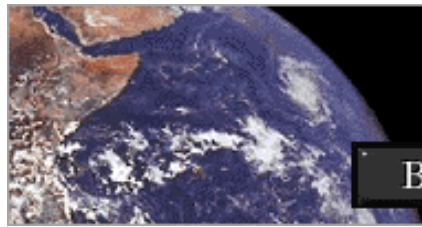

## 29+ Evidences for Macroevolution

### Part 1: The Unique Universal Phylogenetic Tree

Copyright © 1999-2004 by [Douglas Theobald, Ph.D.](#)

---

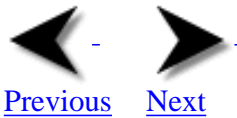

[Previous](#)   [Next](#)

"As buds give rise by growth to fresh buds, and these, if vigorous, branch out and overtop on all sides many a feebler branch, so by generation I believe it has been with the great Tree of Life, which fills with its dead and broken branches the crust of the earth, and covers the surface with its ever-branching and beautiful ramifications."

Charles Darwin  
*The Origin of Species*, p. 171

### Part 1 Outline

1. [The fundamental unity of life](#)
2. [A nested hierarchy of species](#)
3. [Independent determination of the historical phylogeny](#)
  - o [Statistics of incongruent phylogenies](#)
4. [Intermediate and transitional forms](#)
  - o [Reptile-birds](#)
  - o [Reptile-mammals](#)
  - o [Ape-humans](#)
  - o [Legged whales](#)
  - o [Legged seacows](#)
5. [Chronology of common ancestors](#)

### Prediction 1.1: The fundamental unity of life

"OH JEHOVA, quam ampla sunt opera Tua."

- Carolus Linnaeus

at the beginning of *Systema Naturae*, 1757

According to the theory of common descent, modern living organisms, with all their incredible differences, are the progeny of one single species in the distant past. In spite of the extensive variation of form and function among organisms, several fundamental criteria characterize all life. Some of the macroscopic properties that characterize all of life are (1) replication, (2) heritability (characteristics of descendants are correlated with those of ancestors), (3) catalysis, and (4) energy utilization (metabolism). At a very minimum, these four functions are required to generate a physical historical process that can be described by a phylogenetic tree.

If every living species descended from an original species that had these four obligate functions, then all living species today should necessarily have these functions (a somewhat trivial conclusion). Most importantly, however, all modern species should have inherited the *structures* that perform these functions. Thus, a basic prediction of the genealogical relatedness of all life, combined with the constraint of gradualism, is that organisms should be very similar in the particular mechanisms and structures that execute these four basic life processes.

### Confirmation:

The structures that all known organisms use to perform these four basic processes are all quite similar, in spite of the odds. All known living things use polymers to perform these four basic functions. Organic chemists have synthesized hundreds of different polymers, yet the only ones used by life, irrespective of species, are polynucleotides, polypeptides, and polysaccharides. Regardless of the species, the DNA, RNA and proteins used in known living systems all have the same chirality, even though there are at least two chemically equivalent choices of chirality for each of these molecules. For example, RNA has four chiral centers in its ribose ring, which means that it has 16 possible stereoisomers—but only one of these stereoisomers is found in the RNA of known living organisms.

Ten years after the publication of *The Origin of Species*, nucleic acids were first isolated by Friedrich Miescher in 1869. It took another 75 years after this discovery before DNA was identified as the genetic material of life ([Avery et al. 1944](#)). It is quite conceivable that we could have found a different genetic material for each species. In fact, it is still possible that newly identified species might have unknown genetic materials. However, all known life uses the same polymer, polynucleotide (DNA or RNA), for storing species specific information. All known organisms base replication on the duplication of this molecule. The DNA used by living organisms is synthesized using only four nucleosides (deoxyadenosine, deoxythymidine, deoxycytidine, and deoxyguanosine) out of the dozens known (at least [99 occur naturally](#) and many more have been artificially synthesized) ([Rozenski et al. 1999](#); [Voet and Voet 1995](#), p. 969).

In order to perform the functions necessary for life, organisms must catalyze chemical reactions. In all known organisms, enzymatic catalysis is based on the abilities provided by protein molecules (and in relatively rare, yet important, cases by RNA molecules). There are over 320 naturally occurring amino acids known ([Voet and Voet 1995](#), p. 69; [Garavelli et al. 2001](#)); however, the protein molecules used by all known living organisms are constructed with the same subset of 22 amino acids.

There must be a mechanism for transmitting information from the genetic material to the catalytic material; all known organisms, with extremely rare exceptions, use the same genetic code for this. The few known exceptions are, nevertheless, simple and minor variations from the "universal" genetic code (see Figure 1.1.1) ([Lehman 2001](#); [Voet and Voet 1995](#), p. 967), exactly as predicted by evolutionary biologists, if

common descent were correct, years before the genetic code was solved ([Brenner 1957](#); [Crick et al. 1961](#); [Hinegardner and Engelberg 1963](#); [Judson 1996](#), p. 280-281).

UUU Phe	UCU Ser	UAU Tyr	UGU Cys
UUC Phe	UCC Ser	UAC Tyr	UGC Cys
UUA Leu	UCA Ser	UAA <i>Stp, Gln<sup>3</sup></i>	UGA <i>Stp, Trp<sup>4,5</sup>, Cys<sup>6</sup>, SeC<sup>7</sup></i>
UUG Leu	UCG Ser	UAG <i>Stp, Gln<sup>3</sup></i>	UGG Trp
CUU Leu	CCU Pro	CAU His	CGU Arg
CUC Leu	CCC Pro	CAC His	CGC Arg
CUA Leu	CCA Pro	CAA Gln	CGA Arg
CUG Leu, Ser <sup>1</sup>	CCG Pro	CAG Gln	CGG Arg, <i>Usp<sup>5</sup></i>
AUU Ile	ACU Thr	AAU Asn	AGU Ser
AUC Ile	ACC Thr	AAC Asn	AGC Ser
AUA Ile, <i>Usp<sup>2</sup></i>	ACA Thr	AAA Lys	AGA Arg, <i>Usp<sup>9</sup></i>
AUG Met	ACG Thr	AAG Lys	AGG Arg
GUU Val	GCU Ala	GAU Asp	GGU Gly
GUC Val	GCC Ala	GAC Asp	GGC Gly
GUA Val	GCA Ala <i>Res<sup>10</sup></i>	GAA Glu	GGA Gly
GUG Val	GCG Ala	GAG Glu	GGG Gly

**Figure 1.1.1. The standard genetic code and known variant nuclear codes.** (1) *Candida*, a unicellular yeast. (2) *Micrococcus*. (3) ciliated protozoans and green algae. (4) *Mycoplasma*. (5) suppressor codon in bacteria. (6) *Euplotes*. (7) the selenocysteine codon (8) *Spiroplasma*. (9) *Micrococcus*. (10) resume codon in ssrA RNA ([Lehman 2001](#)).

All known organisms use extremely similar, if not the same, metabolic pathways and metabolic enzymes in processing energy-containing molecules. For example, the fundamental metabolic systems in living organisms are glycolysis, the citric acid cycle, and oxidative phosphorylation. In all eukaryotes and in the majority of prokaryotes, glycolysis is performed in the same ten steps, in the same order, using the same ten enzymes ([Voet and Voet 1995](#), p. 445). In addition, the most basic unit of

energy storage, the adenosine triphosphate molecule (ATP), is the same in all species that have been studied.

### Potential Falsification:

Thousands of new species are discovered yearly, and new DNA and protein sequences are determined daily from previously unexamined species ([Wilson 1992](#), Ch. 8). At the [current rate](#), which is increasing exponentially, over 20,000 new sequences are deposited at GenBank every day, amounting to over 34 million new bases sequenced every day. Each and every one is a test of the theory of common descent. When I first wrote these words in 1999, the rate was less than one tenth what it is today (in 2004), and we now have 20 times the amount of DNA sequenced.

Based solely on the theory of common descent and the genetics of known organisms, we strongly predict that we will never find any modern species from known phyla on this Earth with a foreign, non-nucleic acid genetic material. We also make the strong prediction that all newly discovered species that belong to the known phyla will use the "standard genetic code" or a close derivative thereof. For example, according to the theory, none of the thousands of new and previously unknown insects that are constantly being discovered in the Brazilian rainforest will have non-nucleic acid genomes. Nor will these yet undiscovered species of insects have genetic codes which are not close derivatives of the standard genetic code. In the absence of the theory of common descent, it is quite possible that every species could have a very different genetic code, specific to it only, since there are  $1.4 \times 10^{70}$  informationally equivalent genetic codes, all of

which use the same codons and amino acids as the standard genetic code ([Yockey 1992](#)). This possibility could be extremely useful for organisms, as it would preclude interspecific viral infections. However, this has not been observed, and the theory of common descent effectively prohibits such an observation.

As another example, nine new lemur and two marmoset species (all primates) were discovered in the forests of Madagascar and Brazil in 2000 ([Groves 2000](#); [Rasoloarison et al. 2000](#); [Thalmann and Geissmann 2000](#)). Ten new monkey species have been discovered in Brazil alone since 1990 ([Van Roosmalen et al. 2000](#)). Nothing in biology prevents these various species from having a hitherto unknown genetic material or a previously unused genetic code—nothing, that is, except for the theory of common descent. However, we now know definitively that the new lemurs use DNA with the standard genetic code ([Yoder et al. 2000](#)); the marmosets have yet to be tested.

Furthermore, each species could use a different polymer for catalysis. The polymers that are used could still be chemically identical yet have different chiralities in different species. There are thousands of thermodynamically equivalent glycolysis pathways (even using the same ten reaction steps but in different orders), so it is possible that every species could have its own specific glycolysis pathway, tailored to its own unique needs. The same reasoning applies to other core metabolic pathways, such as the citric acid cycle and oxidative phosphorylation.

Finally, many molecules besides ATP could serve equally well as the common currency for energy in various species (CTP, TTP, UTP, ITP, or any ATP-like molecule with one of the 293 known amino acids or one of the dozens of other bases replacing the adenosine moiety immediately come to mind). Discovering any new animals or plants that contained any of the anomalous examples proffered above would be potential falsifications of common ancestry, but they have not been found.

## Prediction 1.2: A nested hierarchy of species

As seen from the phylogeny in [Figure 1](#), the predicted pattern of organisms at any given point in time can be described as "groups within groups", otherwise known as a *nested hierarchy*. The only known processes that specifically generate unique, nested, hierarchical patterns are branching evolutionary processes. Common descent is a genetic process in which the state of the present generation/individual is dependent only upon genetic changes that have occurred since the most recent ancestral population/individual. Therefore, gradual evolution from common ancestors must conform to the mathematics of [Markov processes and Markov chains](#). Using Markovian mathematics, it can be rigorously proven that branching Markovian replicating systems produce nested hierarchies ([Givnish and Sytsma 1997](#); [Harris 1989](#); [Norris 1997](#)). For these reasons, biologists routinely use branching Markov chains to effectively model evolutionary processes, including complex genetic processes, the temporal distributions of surnames in populations ([Galton and Watson 1874](#)), and the behavior of pathogens in epidemics.

The nested hierarchical organization of species contrasts sharply with other possible biological patterns, such as the continuum of "the great chain of being" and the continuums predicted by Lamarck's theory of organic progression ([Darwin 1872](#), pp. 552-553; [Futuyma 1998](#), pp. 88-92). Mere similarity between organisms is not enough to support macroevolution; the nested classification pattern required by a gradual evolutionary process, such as universal common descent, is much more specific than simple similarity. Real world examples that cannot be objectively classified in nested hierarchies are the elementary particles (which are described by quantum chromodynamics), the elements (whose organization is described by quantum mechanics and illustrated by the periodic table), the planets in our Solar System, books in a library, or specially designed objects like buildings, furniture, cars, etc.

Although it is trivial to classify anything subjectively in a hierarchical manner, only certain things can be



classified *objectively* in a consistent, unique nested hierarchy. The difference drawn here between "subjective" and "objective" is crucial and requires some elaboration, and it is best illustrated by example. Different models of cars certainly could be classified hierarchically—perhaps one could classify cars first by color, then within each color by number of wheels, then within each wheel number by manufacturer, etc. However, another individual may classify the same cars first by manufacturer, then by size, then by year, then by color, etc. The particular classification scheme chosen for the cars is subjective. In contrast, human languages, which have common ancestors and are derived by descent with modification, generally can be classified in objective nested hierarchies ([Pei 1949](#); [Ringe 1999](#)). Nobody would reasonably argue that Spanish should be categorized with German instead of with Portuguese.

The difference between classifying cars and classifying languages lies in the fact that, with cars, certain characters (for example, color or manufacturer) must be considered more important than other characters in order for the classification to work. Which types of car characters are more important depends upon the personal preference of the individual who is performing the classification. In other words, certain types of characters must be weighted subjectively in order to classify cars in nested hierarchies; cars do not fall into natural, unique, objective nested hierarchies.

Because of these facts, a cladistic analysis of cars will not produce a unique, consistent, well-supported tree that displays nested hierarchies. A cladistic analysis of cars (or, alternatively, a cladistic analysis of imaginary organisms with randomly assigned characters) will of course result in a phylogeny, but there will be a very large number of other phylogenies, many of them with very different topologies, that are as well-supported by the same data. In contrast, a cladistic analysis of organisms or languages will generally result in a well-supported nested hierarchy, without arbitrarily weighting certain characters ([Ringe 1999](#)). Cladistic analysis of a true genealogical process produces one or relatively few phylogenetic trees that are much more well-supported by the data than the other possible trees.

The degree to which a given phylogeny displays a unique, well-supported, objective nested hierarchy can be rigorously quantified. Several different statistical tests have been developed for determining whether a phylogeny has a subjective or objective nested hierarchy, or whether a given nested hierarchy could have been generated by a chance process instead of a genealogical process ([Swofford 1996](#), p. 504). These tests measure the degree of "cladistic hierarchical structure" (also known as the "phylogenetic signal") in a phylogeny, and phylogenies based upon true genealogical processes give high values of hierarchical structure, whereas subjective phylogenies that have only apparent hierarchical structure (like a phylogeny of cars, for example) give low values ([Archie 1989](#); [Faith and Cranston 1991](#); [Farris 1989](#); [Felsenstein 1985](#); [Hillis 1991](#); [Hillis and Huelsenbeck 1992](#); [Huelsenbeck et al. 2001](#); [Klassen et al. 1991](#)).

There is one caveat to consider with this prediction: if rates of evolution are fast, then cladistic information can be lost over time since it would be essentially randomized. The faster the rate, the less time needed to obliterate information about the historical branching pattern of evolution. Slowly evolving characters let us see farther back into time; faster evolving characters restrict that view to more recent events. If the rate of evolution for a certain character is extremely slow, a nested hierarchy will be observed for that character only for very distantly related taxa. However, "rate of evolution" vs. "time since divergence" is relative; if common descent is true, then in some time frame we will always be able to observe a nested hierarchy for any given character. Furthermore, we know empirically that different characters evolve at different rates (e. g. some genes have higher background mutation rates than others). Thus, if common descent is true, we should observe nested hierarchies over a broad range of time at various biological levels.

Therefore, since common descent is a genealogical process, common descent should produce organisms that can be organized into objective nested hierarchies. Equivalently, we predict that, in general, cladistic analyses of organisms should produce phylogenies that have large, statistically significant values of hierarchical structure (in standard scientific practice, a result with "high statistical significance" is a result

that has a 1% probability or less of occurring by chance [ $P < 0.01$ ]). As a representation of universal common descent, the universal tree of life should have very high, very significant hierarchical structure and phylogenetic signal.

### Confirmation:

Most existing species can be organized rather easily in a nested hierarchical classification. This is evident in the use of the Linnaean classification scheme. Based on shared derived characters, closely related organisms can be placed in one group (such as a genus), several genera can be grouped together into one family, several families can be grouped together into an order, etc.

As a specific example (see [Figure 1](#)), plants can be classified as vascular and nonvascular (i.e. they have or lack xylem and phloem). Nested within the vascular group, there are two divisions, seed and non-seed plants. Further nested within the seed plants are two more groups, the angiosperms (which have enclosed, protected seeds) and the gymnosperms (having non-enclosed seeds). Within the angiosperm group are the monocotyledons and the dicotyledons.

Most importantly, the standard phylogenetic tree and nearly all less inclusive evolutionary phylogenies have statistically significant, high values of hierarchical structure ([Baldauf et al. 2000](#); [Brown et al. 2001](#); [Hillis 1991](#); [Hillis and Huelsenbeck 1992](#); [Klassen et al. 1991](#)).

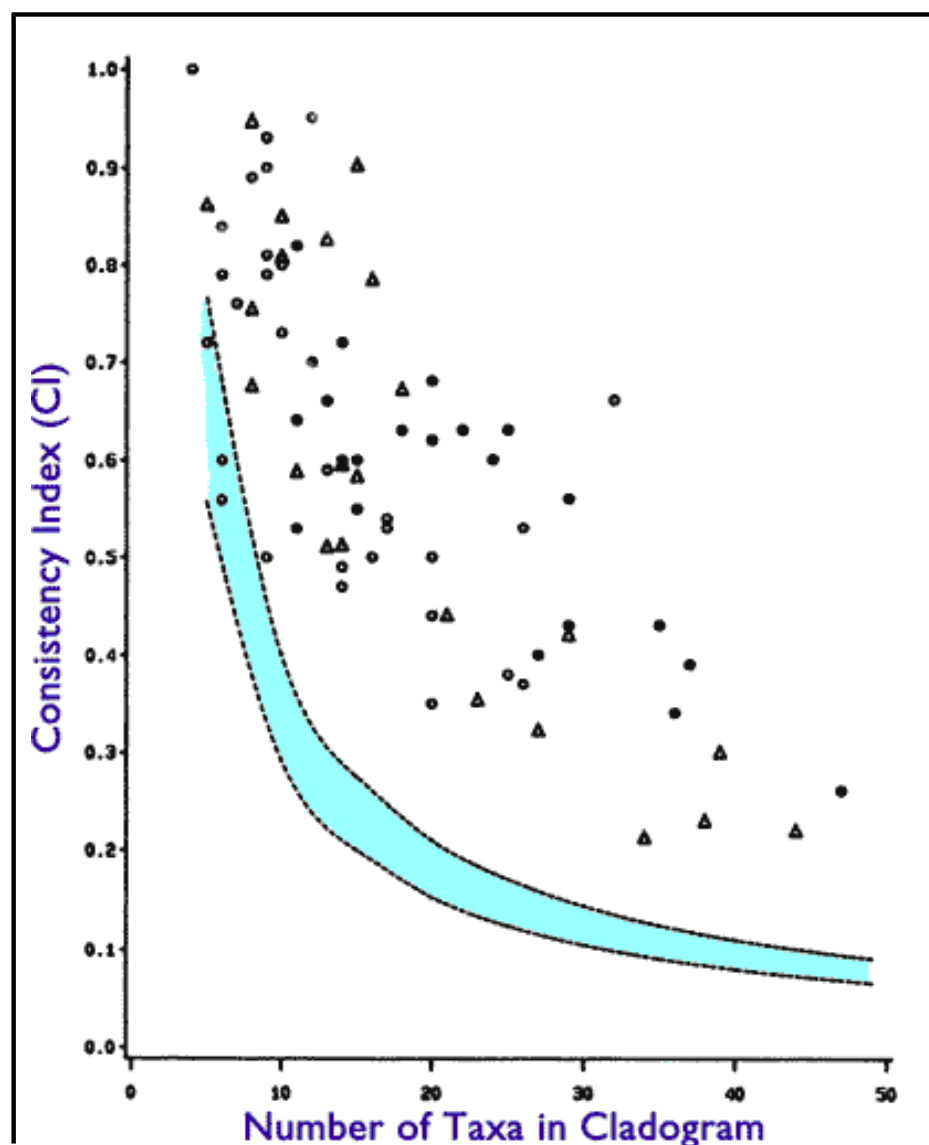

### Potential Falsification:

It would be very problematic if many species were found that combined characteristics of different nested groupings. Proceeding with the previous example, some nonvascular plants could have seeds or flowers, like vascular plants, but they do not. Gymnosperms (e.g. conifers or pines) occasionally could be found with flowers, but they never are. Non-seed plants, like ferns, could be found with woody stems; however, only some angiosperms have woody stems. Conceivably, some birds could have mammary glands or hair; some mammals could have feathers (they are an excellent means of insulation). Certain fish or amphibians could have differentiated or cusped teeth, but these are only characteristics of mammals. A mix and match of characters like this would make it extremely difficult to objectively organize species into nested hierarchies. Unlike organisms, cars *do* have a mix and match of characters, and this is precisely why a nested hierarchy does not flow naturally from

## Number of Taxa in Cladogram

### Figure 1.2.1. A plot of the CI values of cladograms

**versus the number of taxa in the cladograms.** CI values are on the y-axis; taxa number are on the x-axis. The 95% confidence limits are shown in light turquoise. All points above and to the right of the turquoise region are statistically significant high CI values. Similarly, all points below and to the left of the turquoise region are statistically significant *low* values of CI. (reproduced from [Klassen et al. 1991](#), Figure 6).

classification of cars.

If it were impossible, or very problematic, to place species in an objective nested classification scheme (as it is for the car, chair, book, atomic element, and elementary particle examples mentioned above), macroevolution would be effectively disproven. More precisely, if the

phylogenetic tree of all life gave statistically significant *low* values of phylogenetic signal (hierarchical structure), common descent would be resolutely falsified.

In fact, it is possible to have a "reciprocal" pattern from nested hierarchies. Mathematically, a nested hierarchy is the result of specific correlations between certain characters of organisms. When evolutionary rates are fast, characters become randomly distributed with respect to one another, and the correlations are weakened. However, the characters can also be anti-correlated—it is possible for them to be correlated in the opposite direction from what produces nested hierarchies ([Archie 1989](#); [Faith and Cranston 1991](#); [Hillis 1991](#); [Hillis and Huelsenbeck 1992](#); [Klassen et al. 1991](#)). The observation of such an anti-correlated pattern would be a strong falsification of common descent, regardless of evolutionary rates.

One widely used measure of cladistic hierarchical structure is the *consistency index* (CI). The statistical properties of the CI measure were investigated in a frequently cited paper by Klassen *et al.* ([Klassen et al. 1991](#); see [Figure 1.2.1](#)). The exact CI value is dependent upon the number of taxa in the phylogenetic tree under consideration. In this paper, the authors calculated what values of CI were statistically significant for various numbers of taxa. Higher values of CI indicate a greater degree of hierarchical structure.

As an example, a CI of 0.2 is expected from random data for 20 taxa. A value of 0.3 is, however, highly statistically significant. Most interesting for the present point is the fact that a CI of 0.1 for 20 taxa is also highly statistically significant, but it is *low*—it is indicative of anti-cladistic structure. Klassen *et al.* took 75 CI values from published cladograms in 1989 (combined from three papers) and noted how they fared in terms of statistical significance. The cladograms used from 5 to 49 different taxa (i.e. different species). Three of the 75 cladograms fell within the 95% confidence limits for random data, which means that they were indistinguishable from random data. All the rest exhibited highly statistically significant values of CI. None exhibited significant *low* values; none displayed an anti-correlated, anti-hierarchical pattern.

Note, this study was performed before there were measures of statistical significance which would allow researchers to "weed out" the bad cladograms. Predictably, the three "bad" data sets considered under ten taxa—it is of course more difficult to determine statistical significance with very little data. Seventy-five independent studies from different researchers, on different organisms and genes, with high values of CI ( $P < 0.01$ ) is an incredible confirmation with an astronomical degree of combined statistical significance ( $P \ll 10^{-300}$ , [Bailey and Gribskov 1998](#); [Fisher 1990](#)). If the reverse were true—if studies such as this gave statistically significant values of CI (i.e. cladistic hierarchical structure) which were lower than that expected from random data—common descent would have been firmly falsified.

Keep in mind that about 1.5 million species are known currently, and that the majority of these species has been discovered since Darwin first stated his hypothesis of common ancestry. Even so, they all have fit the correct hierarchical pattern within the error of our methods. Furthermore, it is estimated that only 1 to 10% of all living species has even been catalogued, let alone studied in detail. New species discoveries pour in daily, and each one is a test of the theory of common descent ([Wilson 1992](#), Ch. 8).

## Prediction 1.3: Consilience of independent phylogenies

"It will be determined to what extent the phylogenetic tree, as derived from molecular data in complete independence from the results of organismal biology, coincides with the phylogenetic tree constructed on the basis of organismal biology. If the two phylogenetic trees are mostly in agreement with respect to the topology of branching, the best available single proof of the reality of macro-evolution would be furnished. Indeed, only the theory of evolution, combined with the realization that events at any supramolecular level are consistent with molecular events, could reasonably account for such a congruence between lines of evidence obtained independently, namely amino acid sequences of homologous polypeptide chains on the one hand, and the finds of organismal taxonomy and paleontology on the other hand. Besides offering an intellectual satisfaction to some, the advertising of such evidence would of course amount to beating a dead horse. Some beating of dead horses may be ethical, when here and there they display unexpected twitches that look like life."

[Emile Zuckerkandl and Linus Pauling](#), *discussing the possibility of the twin nested hierarchy before the first molecular phylogenies had been made.* (1965) "Evolutionary Divergence and Convergence in Proteins." in **Evolving Genes and Proteins**, p. 101.

Here we commence to beat Pauling's poor 40-year dead horse. If there is one historical phylogenetic tree which unites all species in an objective genealogy, all separate lines of evidence should converge on the same tree ([Penny et al. 1982](#); [Penny et al. 1991](#); [Zuckerkandl and Pauling 1965](#)). Independently derived phylogenetic trees of all organisms should match each other with a high degree of statistical significance.

### Confirmation:

Well-determined phylogenetic trees inferred from the independent evidence of morphology and molecular sequences match with an extremely high degree of statistical significance. Many genes with very basic cellular functions are ubiquitous—they occur in the genomes of most or all organisms. An oft-cited example is the cytochrome *c* gene. Since all eukaryotes contain the gene for this essential protein, neither its presence nor its function correlates with organismal morphology. Additionally, because of the fact of DNA coding redundancy, parts of certain DNA sequences have absolutely no correlation with phenotype (e.g. certain introns or the four-fold degenerate third-base position of most DNA codons). Due to these two aspects of certain DNA sequences, ubiquity and redundancy, DNA sequences can be carefully chosen that constitute completely independent data from morphology. (See [point 17](#) and [18](#) for more background about the molecular sequence evidence and for more detail about how it is independent of morphology.) The degree of phylogenetic congruence between these independent data sets is nothing short of incredible.

In science, independent measurements of theoretical values are never exact. When inferring any value (such as a physical constant like the charge of the electron, the mass of the proton, or the speed of light) some error always exists in the measurement, and all independent measurements are incongruent to some extent. Of course, the true value of something is never known for certain in science—all we have are measurements that we hope approximate the true value. Scientifically, then, the important relevant questions are "When comparing two measurements, how much of a discrepancy does it take to be a problem?" and "How close must the measurements be in order to give a strong confirmation?" Scientists answer these questions quantitatively with probability and statistics ([Box 1978](#); [Fisher 1990](#); [Wadsworth 1997](#)). To be scientifically rigorous we require statistical significance. Some measurements of a given value match with statistical significance (good), and some do not (bad), even though no measurements match *exactly* (reality).

So, how well do phylogenetic trees from morphological studies match the trees made from independent molecular studies? There are over  $10^{38}$  different possible ways to arrange the 30 major taxa represented in [Figure 1](#) into a phylogenetic tree (see [Table 1.3.1](#); [Felsenstein 1982](#); [Li 1997](#), p. 102). In spite of these odds, the relationships given in [Figure 1](#), as determined from morphological characters, are completely congruent with the relationships determined independently from cytochrome *c* molecular studies (for consensus phylogenies from pre-molecular studies see [Carter 1954](#), [Figure 1](#), p. 13; [Dodson 1960](#), [Figures 43](#), p. 125, and [Figure 50](#), p. 150; [Osborn 1918](#), [Figure 42](#), p. 161; [Haeckel 1898](#), p. 55; [Gregory 1951](#), [Fig. opposite title page](#); for phylogenies from the early cytochrome *c* studies see [McLaughlin and Dayhoff 1973](#); [Dickerson and Timkovich 1975](#), pp. 438-439). Speaking quantitatively, independent morphological and molecular measurements such as these have determined the standard phylogenetic tree, as shown in [Figure 1](#), to better than 38 decimal places. This phenomenal corroboration of universal common descent is referred to as the "twin nested hierarchy". This term is something of a misnomer, however, since there are in reality multiple nested hierarchies, independently determined from many sources of data.

When two independently determined trees mismatch by some branches, they are called "incongruent". In general, phylogenetic trees may be very incongruent and still [match with an extremely high degree of statistical significance](#) ([Hendy et al. 1984](#); [Penny et al. 1982](#); [Penny and Hendy 1986](#); [Steel and Penny 1993](#)). Even for a phylogeny with a small number of organisms, the total number of possible trees is extremely large. For example, there are about a thousand different possible phylogenies for only six organisms; for nine organisms, there are millions of possible phylogenies; for 12 organisms, there are nearly 14 trillion different possible phylogenies ([Table 1.3.1](#); [Felsenstein 1982](#); [Li 1997](#), p. 102). Thus, the probability of finding two similar trees by chance via two independent methods is extremely small in most cases. In fact, two different trees of 16 organisms that mismatch by as many as 10 branches still match with high statistical significance ([Hendy et al. 1984](#), [Table 4](#); [Steel and Penny 1993](#)). For more information on the statistical significance of trees that do not match exactly, see "[Statistics of Incongruent Phylogenetic Trees](#)".

The stunning degree of match between even the most incongruent phylogenetic trees found in the biological literature is widely unappreciated, mainly because most people (including many biologists) are unaware of the mathematics involved ([Bryant et al. 2002](#); [Penny et al. 1982](#); [Penny and Hendy 1986](#)). Penny and Hendy have performed a series of detailed statistical analyses of the significance of incongruent phylogenetic trees, and here is their conclusion:

**Table 1.3.1: Number of possible phylogenetic trees for a given number of taxa**

Number of taxa		Number of possible trees
rooted	unrooted	$N_R = \frac{(2n-3)!!}{(2^{n-2}(n-2)!)}$
2	3	1
3	4	3
4	5	15
5	6	105
6	7	945
7	8	10,395
8	9	135,135
9	10	2,027,025
10	11	34,459,425
11	12	654,729,075
12	13	13,749,310,575
13	14	316,234,143,225
14	15	7,905,853,580,625
15	16	213,458,046,676,875
16	17	6,190,283,353,629,375
17	18	191,898,783,962,510,625
18	19	6,332,659,870,762,850,625
19	20	221,643,095,476,699,771,875
20	21	8,200,794,532,637,891,559,375

**Phylogenetic Trees Calculator**

**rooted      unrooted**

**Number of Taxa:**

**Number of different trees =**  
***1.2e+50 means  $1.2 \times 10^{50}$***

"Biologists seem to seek the 'The One Tree' and appear not to be satisfied by a range of options. However, there is no logical difficulty in having a range of trees. There are 34,459,425 possible [unrooted] trees for 11 taxa ([Penny et al. 1982](#)), and to reduce this to the order of 10-50 trees is analogous to an accuracy of measurement of approximately one part in  $10^6$ ." ([Penny and Hendy 1986](#), p. 414)

For a more realistic universal phylogenetic tree with dozens of taxa including all known phyla, the accuracy is better by many orders of magnitude. To put the significance of this incredible confirmation in perspective, consider the modern theory of gravity. Both Newton's Theory of Universal Gravitation and Einstein's General Theory of Relativity rely upon a fundamental physical constant,  $G$ , the gravitational constant. If these theories of gravity are correct, independent methods should determine similar values for  $G$ . However, to date, very precise independent measurements of the gravitational constant  $G$  disagree by nearly 1% ([Kestenbaum 1998](#); [Quinn 2000](#)). Here is how David Kestenbaum describes the current scientific status of the theory of gravity, as reported in the prestigious journal *Science*:

"While the charge of the electron is known to seven decimal places, physicists lose track of  $G$  after only [the third](#). For some, that's an embarrassment. 'It grates on me like a burr in the saddle,' says Alvin Sanders, a physicist at the University of Virginia in Charlottesville. Over the past few decades, he and a handful of other physicists have dedicated themselves to measuring  $G$  more accurately. To their dismay, they've come up with wildly different values. 'You might say we've had negative progress,' says Barry Taylor, a physicist at the National Institute of Standards and Technology (NIST) in Gaithersburg, Maryland. ...

'Nobody understands it [the far-out results of the PTB, the German standards lab in Braunschweig],' says Meyer. 'They must have made an unbelievable mistake, but we cannot find it.' ... says Terry Quinn, 'we may just have to throw the PTB result out.'" ([Kestenbaum 1998](#))

Over two years later, the same Terry Quinn (of the International Bureau of Weights and Measures [BIPM] in Sèvres, France) summarized the situation in a review for the journal *Nature*:

"The current interest in measuring  $G$  was stimulated by the publication in 1996 of a value for  $G$  that differed by 0.6% from the accepted value given in the previous 1986 CODATA report. To take account of this, the 1998 [CODATA report](#) recommends a value for  $G$  ... with an uncertainty of 0.15%, some ten times worse than in 1986. Whereas the other fundamental constants were more accurately known in 1998 than in 1986, the uncertainty in  $G$  increased dramatically. The  $G$  community appeared to be going backwards rather than forwards." ([Quinn 2000](#))

Nevertheless, a precision of just under 1% is still pretty good; it is not enough, at this point, to cause us to cast much doubt upon the validity and usefulness of modern theories of gravity. However, if tests of the theory of common descent performed that poorly, different phylogenetic trees, as shown in Figure 1, would have to [differ by 18 of the 30 branches](#)! In their quest for scientific perfection, some biologists are rightly rankled at the obvious discrepancies between some phylogenetic trees ([Gura 2000](#); [Patterson et al. 1993](#); [Maley and Marshall 1998](#)). However, as illustrated in [Figure 1](#), the standard phylogenetic tree is known to 38 decimal places, which is a much greater precision than that of even the most well-determined physical constants. For comparison, the charge of the electron is known to only seven decimal places, the Planck

constant is known to only eight decimal places, the mass of the neutron, proton, and electron are all known to only nine decimal places, and the universal gravitational constant has been determined to only three decimal places.

Furthermore, if common descent is true, we expect that including more data in phylogenetic analyses will increase the correspondence between phylogenetic trees. As explained in the [phylogenetic caveats sidebar](#), gene trees are not equivalent to species trees ([Avice and Wollenberg 1997](#); [Fitch 1970](#); [Hudson 1992](#); [Nichols 2001](#); [Wu 1991](#)). Genetics and heredity are stochastic (i.e. probabilistic) processes, and consequently we expect that phylogenies constructed with *single* genes will be partially incongruent. However, including multiple independent genes in a phylogenetic analysis should circumvent this difficulty; in general more than five independent genes are needed to accurately reconstruct a species phylogeny ([Wu 1991](#)). Phylogenetic trees constructed with multiple genes should thus be more accurate than those constructed with single genes, and indeed combined gene trees are more congruent ([Baldauf et al. 2000](#); [Hedges 1994](#); [Hedges and Poling 1999](#); [Penny et al. 1982](#)).

### Potential Falsification:

When it became possible to sequence biological molecules, the realization of a markedly different tree based on the independent molecular evidence would have been a fatal blow to the theory of evolution, even though that is by far the most likely result. More precisely, the common descent hypothesis would have been falsified if the universal phylogenetic trees determined from the independent molecular and morphological evidence did not match with statistical significance. Furthermore, we are now in a position to begin construction of phylogenetic trees based on other independent lines of data, such as chromosomal organization. In a very general sense, chromosome number and length and the chromosomal position of genes are all causally independent of both morphology and of sequence identity. Phylogenies constructed from these data should recapitulate the standard phylogenetic tree as well ([Hillis et al. 1996](#); [Li 1997](#)).

### Criticisms:

One common objection is the assertion that anatomy is not independent of biochemistry, and thus anatomically similar organisms are likely to be similar biochemically (e.g. in their molecular sequences) simply for functional reasons. According to this argument, then, we should expect phylogenies based on molecular sequences to be similar to phylogenies based on morphology even if organisms are not related by common descent. This argument is very wrong. There is no known biological reason, besides common descent, to suppose that similar morphologies must have similar biochemistry. Though this logic may seem quite reasonable initially, all of molecular biology refutes this "common sense" correlation. In general, similar DNA and biochemistry give similar morphology and function, but the converse is not true—similar morphology and function is not necessarily the result of similar DNA or biochemistry. The reason is easily understood once explained; many very different DNA sequences or biochemical structures can result in the same functions and the same morphologies (see [predictions 4.1](#) and [4.2](#) for a detailed explanation).

As a close analogy, consider computer programs. Netscape works essentially the same on a Macintosh, an IBM, or a Unix machine, but the binary code for each program is quite different. Computer programs that perform the same functions can be written in most any computer language—Basic, Fortran, C, C++, Java, Pascal, etc. and identical programs can be compiled into binary code many different ways. Furthermore, even using the same computer language, there are many different ways to write any specific computer program, even using the same algorithms and subroutines. In the end, there is no reason to suspect that similar computer programs are written with similar code, based solely on the function of the program. This is the reason why software companies keep their source code secret, but they don't care that competitors can use their programs—it is essentially impossible to deduce the program code from the function and

operation of the software. The same conclusion applies to biological organisms, for very similar reasons.

To reiterate, although similar genotypes (e.g. molecular sequences) often give similar phenotypes (e.g. morphological characters), similar phenotypes are not necessarily the result of similar genotypes. Thus, it is entirely possible that phylogenetic trees constructed from genotypic data could be radically different from phylogenetic trees constructed from phenotypic data. In fact, in the absence of common descent or any other reason to suppose that these two types of trees should be similar, the most likely result by far is that they will be radically different. This is precisely why it is possible to falsify the macroevolutionary prediction that independently derived phylogenies should be similar.

## Prediction 1.4: Intermediate and transitional forms: the possible morphologies of predicted common ancestors

- [Example 1: reptile-birds](#)
- [Example 2: reptile-mammals](#)
- [Example 3: ape-humans](#)
- [Example 4: legged whales](#)
- [Example 5: legged seacows](#)

All fossilized animals found should conform to the standard phylogenetic tree. If all organisms are united by descent from a common ancestor, then there is one single true historical phylogeny for all organisms. Similarly, there is one single true historical genealogy for any individual human. It directly follows that if there is a unique universal phylogeny, then all organisms, both past and present, fit in that phylogeny uniquely. Since the standard phylogenetic tree is the best approximation of the true historical phylogeny, we expect that all fossilized animals should conform to the standard phylogenetic tree within the error of our scientific methods.

Every node shared between two branches in a phylogeny or cladogram represents a predicted common ancestor; thus there are ~29 common ancestors predicted from the tree shown in [Figure 1](#). Our standard tree shows that the bird grouping is most closely related to the reptilian grouping, with a node linking the two (A in [Figure 1](#)); thus we predict the possibility of finding fossil [intermediates](#) between birds and reptiles. The same reasoning applies to mammals and reptiles (B in [Figure 1](#)). However, we predict that we should never find fossil intermediates between birds and mammals.

It should be pointed out that there is no requirement for intermediate organisms to go extinct. In fact, all living organisms can be thought of as intermediate between adjacent taxa in a phylogenetic tree. For instance, modern reptiles are intermediate between amphibians and mammals, and reptiles are also intermediate between amphibians and birds. As far as macroevolutionary predictions of morphology are concerned, this point is trivial, as it is essentially just a restatement of the concept of a nested hierarchy.

However, a phylogenetic tree does make significant predictions about the morphology of intermediates which no longer exist or which have yet to be discovered. Each predicted common ancestor has a set of explicitly specified morphological characteristics, based on each of the most common derived characters of its descendants and based upon the transitions that must have occurred to transform one taxa into another ([Cunningham et al. 1998](#); [Futuyma 1998](#), pp. 107-108). From the knowledge of avian and reptilian morphology, it is possible to predict some of the characteristics that a reptile-bird intermediate should have, if found. Therefore, we expect the possibility of finding reptile-like fossils with feathers, bird-like fossils with teeth, or bird-like fossils with long reptilian tails. However, we do not expect transitional fossils between birds and mammals, like mammalian fossils with feathers or bird-like fossils with mammalian-style middle ear bones.



## Confirmation:

### Example 1: bird-reptiles

In the case just mentioned, we have found a quite complete set of [dinosaur-to-bird transitional fossils](#) with no morphological "gaps" ([Sereno 1999](#)), represented by *Eoraptor*, *Herrerasaurus*, *Ceratosaurus*, *Allosaurus*, *Compsognathus*, *Sinosauropteryx*, *Protarchaeopteryx*, *Caudipteryx*, *Velociraptor*, *Sinovenator*, *Beipiaosaurus*, *Sinornithosaurus*, *Microraptor*, [Archaeopteryx](#), *Rahonavis*, [Confuciusornis](#), *Sinornis*, *Patagopteryx*, *Hesperornis*, *Apsaravis*, *Ichthyornis*, and *Columba*, among many others ([Carroll 1997](#), pp. 306-323; [Norell and Clarke 2001](#); [Sereno 1999](#); [Xu et al. 1999](#); [Xu et al. 2000](#); [Xu et al. 2002](#)). All have the expected possible morphologies (see [Figure 3.1.1](#) from [Prediction 3.1](#) for a few examples), including organisms such as [Protarchaeopteryx](#), [Caudipteryx](#), and the famous "BPM 1 3-13" (an unnamed dromaeosaur from China) which are flightless bipedal dinosaurs with modern-style feathers ([Chen et al. 1998](#); [Qiang et al. 1998](#); [Norell et al. 2002](#)). Additionally, several similar flightless dinosaurs have been found covered with nascent evolutionary precursors to modern feathers (branched feather-like integument indistinguishable from the contour feathers of true birds), including [Sinornithosaurus](#) ("Bambiraptor"), [Sinosauropteryx](#), *Beipiaosaurus*, *Microraptor*, and an unnamed dromaeosaur specimen, [NGMC 91](#), informally called "Dave" ([Ji et al. 2001](#)). The [All About Archaeopteryx FAQ](#) gives a detailed listing of the [various characters of Archaeopteryx which are intermediate between reptiles and modern birds](#).

### Example 2: reptile-mammals

We also have an exquisitely complete series of fossils for the [reptile-mammal intermediates](#), ranging from the pelycosauria, therapsida, cynodonta, up to primitive mammalia ([Carroll 1988](#), pp. 392-396; [Futuyma 1998](#), pp. 146-151; [Gould 1990](#); [Kardong 2002](#), pp. 255-275). As mentioned above, the standard phylogenetic tree indicates that mammals gradually evolved from a reptile-

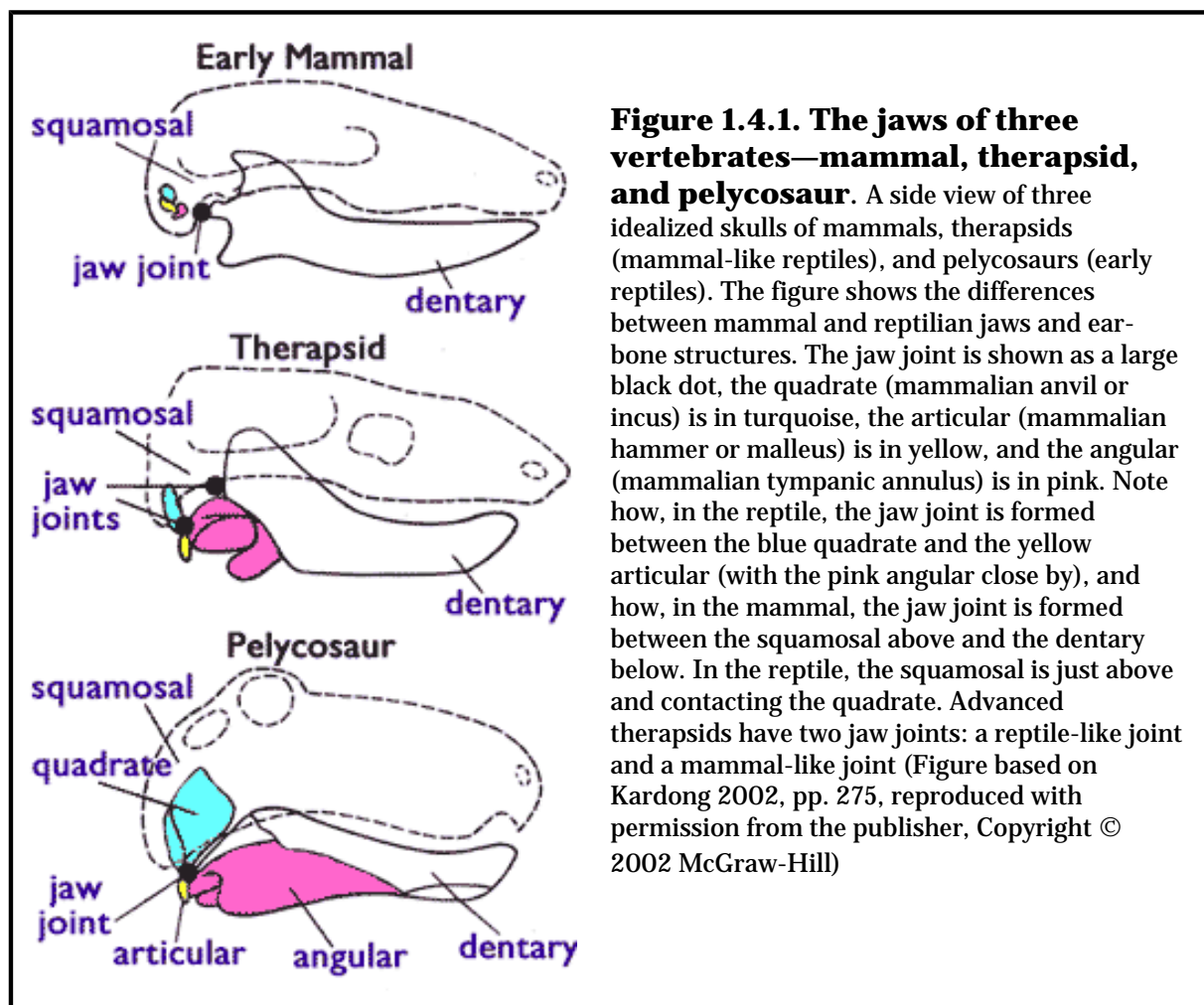

**Figure 1.4.1. The jaws of three vertebrates—mammal, therapsid, and pelycosaur.** A side view of three idealized skulls of mammals, therapsids (mammal-like reptiles), and pelycosaurs (early reptiles). The figure shows the differences between mammal and reptilian jaws and ear-bone structures. The jaw joint is shown as a large black dot, the quadrate (mammalian anvil or incus) is in turquoise, the articular (mammalian hammer or malleus) is in yellow, and the angular (mammalian tympanic annulus) is in pink. Note how, in the reptile, the jaw joint is formed between the blue quadrate and the yellow articular (with the pink angular close by), and how, in the mammal, the jaw joint is formed between the squamosal above and the dentary below. In the reptile, the squamosal is just above and contacting the quadrate. Advanced therapsids have two jaw joints: a reptile-like joint and a mammal-like joint (Figure based on Kardong 2002, pp. 275, reproduced with permission from the publisher, Copyright © 2002 McGraw-Hill)

like ancestor, and

that transitional species must have existed which were morphologically intermediate between reptiles and mammals—even though none are found living today. However, there are significant morphological differences between modern reptiles and modern mammals. Bones, of course, are what fossilize most readily, and that is where we look for transitional species from the past. Osteologically, two major striking differences exist between reptiles and mammals: (1) reptiles have at least four bones in the lower jaw (e.g. the dentary, articular, angular, surangular, and coronoid), while mammals have only one (the dentary), and (2) reptiles have only one middle ear bone (the stapes), while mammals have three (the hammer, anvil, and stapes) (see Figure 1.4.1).

Early in the 20<sup>th</sup> century, developmental biologists discovered something that further complicates the picture. In the reptilian fetus, two developing bones from the head eventually form two bones in the reptilian lower jaw, the quadrate and the articular (see the Pelycosaur in Figure 1.4.1). Surprisingly, the corresponding developing bones in the mammalian fetus eventually form the anvil and hammer of the unique mammalian middle ear (also known more formally as the incus and malleus, respectively; see Figure 1.4.2) (Gilbert 1997, pp. 894-896). These facts strongly indicated that the hammer and anvil had evolved from these reptilian jawbones—that is, if common descent was in fact true. This result was so striking, and the required intermediates so outlandish, that many anatomists had extreme trouble imagining how transitional forms bridging these morphologies could have existed while retaining function. Young-earth creationist Duane Gish stated the problem this way:

"All mammals, living or fossil, have a single bone, the dentary, on each side of the lower jaw, and all mammals, living or fossil, have three auditory ossicles or ear bones, the malleus, incus and stapes. ... Every reptile, living or fossil, however, has at least four bones in the lower jaw and only one auditory ossicle, the stapes. ... There are no transitional fossil forms showing, for instance, three or two jawbones, or two ear bones. No one has explained yet, for that matter, how the transitional form would have managed to chew while his jaw was being unhinged and rearticulated, or how he would hear while dragging two of his jaw bones up into his ear." (Gish 1978, p. 80)

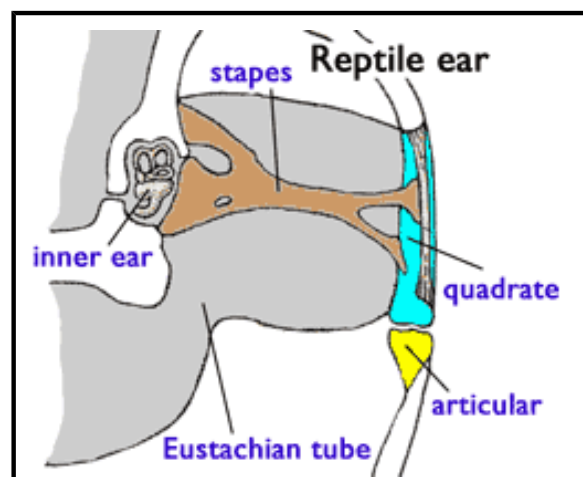

Gish was incorrect in stating that there were no transitional fossil forms, and he has been corrected on this gaff numerous times since he wrote these words. However, Gish's statements nicely delineate the morphological conundrum at hand. Let's review the required evolutionary conclusion. During their evolution, two mammalian middle ear bones (the hammer and anvil, *aka* malleus and incus) were derived from two reptilian jawbones. Thus there was a major evolutionary transition in which several reptilian jawbones (the quadrate, articular, and angular) were extensively reduced and modified gradually to form the modern mammalian middle ear. At the same time, the dentary bone, a part of the reptilian jaw, was expanded to form the major mammalian lower jawbone. During the course of this change, the bones that form the hinge joint of the jaw changed identity. Importantly, the reptilian jaw joint is formed at the intersection of the quadrate and articular whereas the mammalian jaw joint is formed at the intersection of the squamosal and dentary (see Figure 1.4.1).

How could hearing and jaw articulation be preserved during this transition? As clearly shown from the many transitional fossils

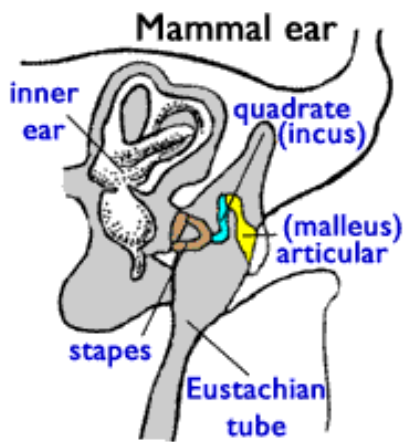
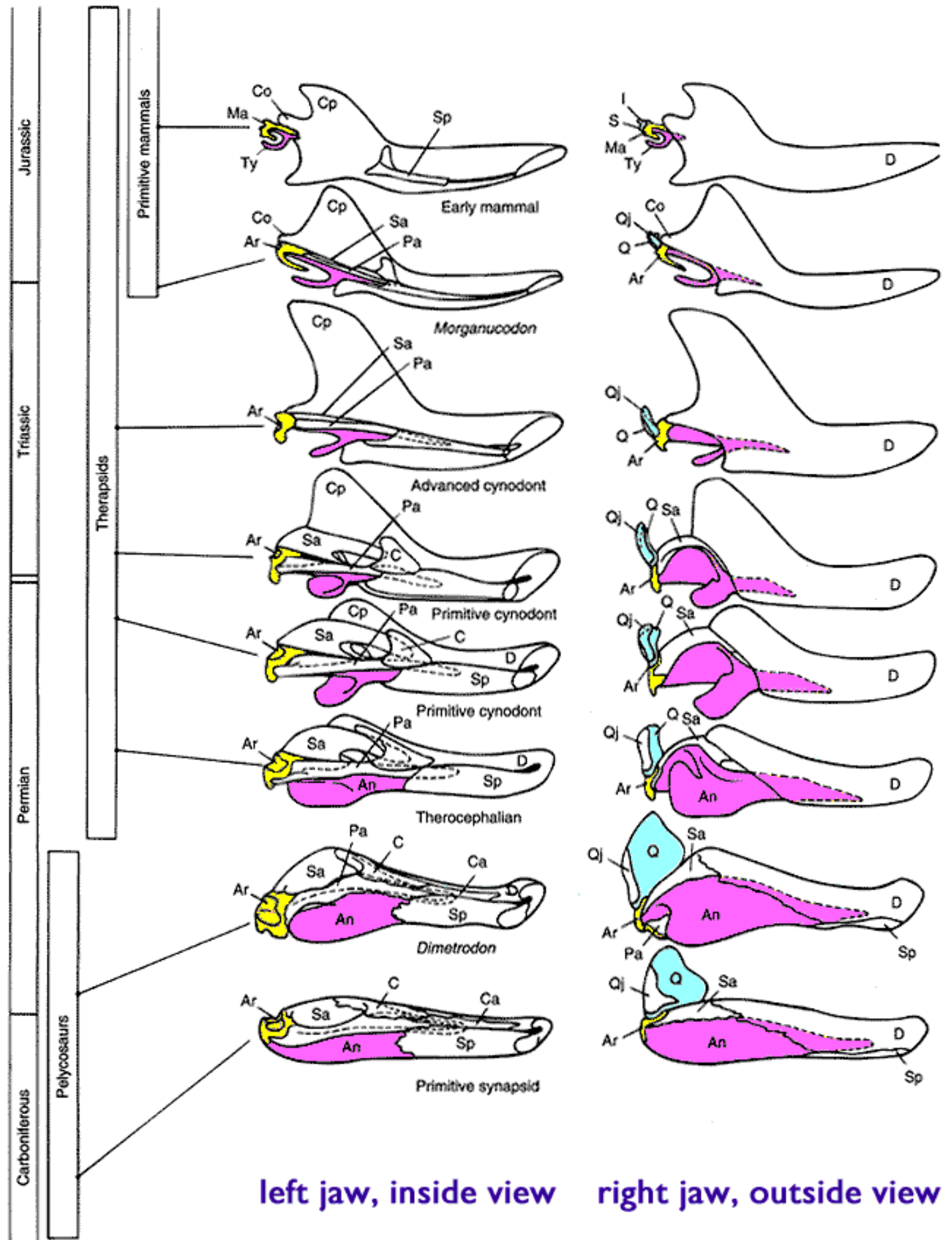

**Figure 1.4.2. A comparison of the ears of reptiles and mammals.** The reptile ear is shown on the left, the mammal ear on the right. As in Figure 1.4.1, the quadrate (mammalian anvil or incus) is in turquoise and the articular (mammalian hammer or malleus) is in yellow. The stapes is shown in brown. Note how the relative arrangement of these bones is similar in both taxa, in the order of inner ear-stapes-quadrate-articular.

that have been found (see Figure 1.4.3), the bones that transfer sound in the reptilian and mammalian ear were in contact with each other throughout the evolution of this transition. In reptiles, the stapes contacts the quadrate, which in turn contacts the articular. In mammals, the stapes contacts the incus, which in turn contacts the malleus (see Figure 1.4.2). Since the quadrate evolved into the incus, and the articular evolved into the malleus, these three bones were in constant contact during this impressive evolutionary change. Furthermore, a functional jaw joint was maintained by redundancy—several of the intermediate fossils have *both* a reptilian jaw joint (from the quadrate and articular) *and* a mammalian jaw joint (from the dentary and squamosal). Several late cynodonts and *Morganucodon* clearly have a double-jointed jaw. In this way, the reptilian-style jaw joint was freed to evolve a new specialized function in the middle ear. It is worthy of note that some modern species of snakes have a double-jointed jaw involving different bones, so such a mechanical arrangement is certainly possible and functional.

Since Figure 1.4.3 was made, several important intermediate fossils have been discovered that fit between *Morganucodon* and the earliest mammals. These new discoveries include a complete skull of *Hadrocodium wui* (Luo *et al.* 2001) and cranial and jaw material from *Repenomamus* and *Gobiconodon* (Wang *et al.* 2001). These new fossil finds clarify exactly when and how the malleus, incus, and angular completely detached from the lower jaw and became solely auditory ear ossicles.

Recall that Gish stated: "There are no transitional fossil forms showing, for instance, three or two jawbones, or two ear bones" (Gish 1978, p. 80). Gish simply does not understand how gradual transitions happen (something he should understand, obviously, if he intends to criticize evolutionary theory). These fossil intermediates illustrate why Gish's statement is a gross mischaracterization of how a transitional form should look. In several of the known intermediates, the bones have overlapping functions, and one bone can be called both an ear bone and a jaw bone; these bones serve two functions. Thus, there is no reason to expect transitional forms with intermediate numbers of jaw bones or ear bones. For example, in *Morganucodon*, the quadrate (anvil) and the articular (hammer) serve as mammalian-style ear bones *and* reptilian jaw bones simultaneously. In fact, even in modern reptiles the quadrate and articular serve to transmit sound to the stapes and the inner ear (see Figure 1.4.2). The relevant transition, then, is a process where the ear bones, initially located in the lower jaw, become specialized in function by eventually detaching from the lower jaw and moving closer to the inner ear.



left jaw, inside view

right jaw, outside view

**Figure 1.4.3. A comparison of the jawbones and ear-bones of several transitional forms in the evolution of mammals.** Approximate stratigraphic ranges of the various taxa are indicated at the far left (more recent on top). The left column of jawbones shows the view of the left jawbone from the inside of the mouth. The right column is the view of the right jawbone from the right side (outside of the skull). As in Figure 1.4.1, the quadrate (mammalian anvil or incus) is in turquoise, the articular (mammalian hammer or malleus) is in yellow, and the angular (mammalian tympanic annulus) is in pink. For clarity, the teeth are not shown, and the squamosal upper jawbone is omitted (it replaces the quadrate in the mammalian jaw joint, and forms part of the jaw joint in advanced cynodonts and *Morganucodon*). Q = quadrate, Ar = articular, An = angular, I = incus (anvil), Ma = malleus (hammer), Ty = tympanic annulus, D = dentary. (Reproduced from Kardong 2002, pp. 274, with permission from the publisher, Copyright © 2002 McGraw-Hill)

### Example 3: human-apes

"All advances by degrees in Nature, and nothing by leaps, and this law as applied to each, is part of my doctrine of Continuity. Although there may exist in some other world species intermediate between Man and the Apes, Nature has thought it best to remove them from us, in order to establish our superiority beyond question. I speak of intermediate species, and by no means limit myself to those leading to Man."

Gottfried Wilhelm Leibniz  
*Protogaea* 1749

One of the most celebrated examples of transitional fossils is our [collection of fossil hominids](#) (see Figure 1.4.4 below). Based upon the consensus of numerous phylogenetic analyses, *Pan troglodytes* (the chimpanzee) is the closest living relative of humans. Thus, we expect that organisms lived in the past which were intermediate in morphology between humans and chimpanzees. Over the past century, many spectacular paleontological finds have identified such transitional hominid fossils.



**Figure 1.4.4. Fossil hominid skulls.** (Images © 2000 [Smithsonian Institution](#).) [\(larger 76K JPG\)](#)

[version\)](#)

- (A) *Pan troglodytes*, chimpanzee, modern
- (B) [Australopithecus africanus, STS 5](#), 2.6 My
- (C) [Australopithecus africanus, STS 71](#), 2.5 My
- (D) *Homo habilis*, [KNM-ER 1813](#), 1.9 My
- (E) *Homo habilis*, [OH24](#), 1.8 My
- (F) *Homo rudolfensis*, [KNM-ER 1470](#), 1.8 My
- (G) *Homo erectus*, [Dmanisi cranium D2700](#), 1.75 My
- (H) [Homo ergaster](#) (early *H. erectus*), [KNM-ER 3733](#), 1.75 My
- (I) *Homo heidelbergensis*, ["Rhodesia man,"](#) 300,000 - 125,000 y
- (J) [Homo sapiens neanderthalensis, La Ferrassie 1](#), 70,000 y
- (K) [Homo sapiens neanderthalensis, La Chappelle-aux-Saints](#), 60,000 y
- (L) [Homo sapiens neanderthalensis, Le Moustier](#), 45,000 y
- (M) [Homo sapiens sapiens, Cro-Magnon I](#), 30,000 y
- (N) *Homo sapiens sapiens*, modern

#### Example 4: legged fossil whales

"Finally, and most glaringly obvious, if random evolution is true there must have been a large number of transitional forms between the mesonychid and the ancient whale: Where are they? It seems like quite a coincidence that of all the intermediate species that must have existed between the mesonychid and whale, only species that are very similar to the end species have been found. ([Behe 1994](#))"

- Michael J. Behe

Anti-Darwinian, Intelligent Design conjecturist,  
*writing against the validity of evolution less than a year before three transitional species between whales and land-dwelling Eocene Mesonychids were found.*

Another impressive example of incontrovertible transitional forms predicted to exist by evolutionary biologists is the collection of [land mammal-to-whale fossil intermediates](#). Whales, of course, are sea animals with flippers, lacking external hindlimbs. Since they are also mammals, the consensus phylogeny indicates that whales and dolphins evolved from land mammals with legs. In recent years, we have found several transitional forms of whales with legs, both capable and incapable of terrestrial locomotion ([Bajpai and Gingerich 1998](#); [Gingerich et al. 1983](#); [Gingerich et al. 1990](#); [Gingerich et al. 1994](#); [Gingerich et al. 2001](#); [Thewissen et al. 2001](#)).

#### Example 5: legged seacows

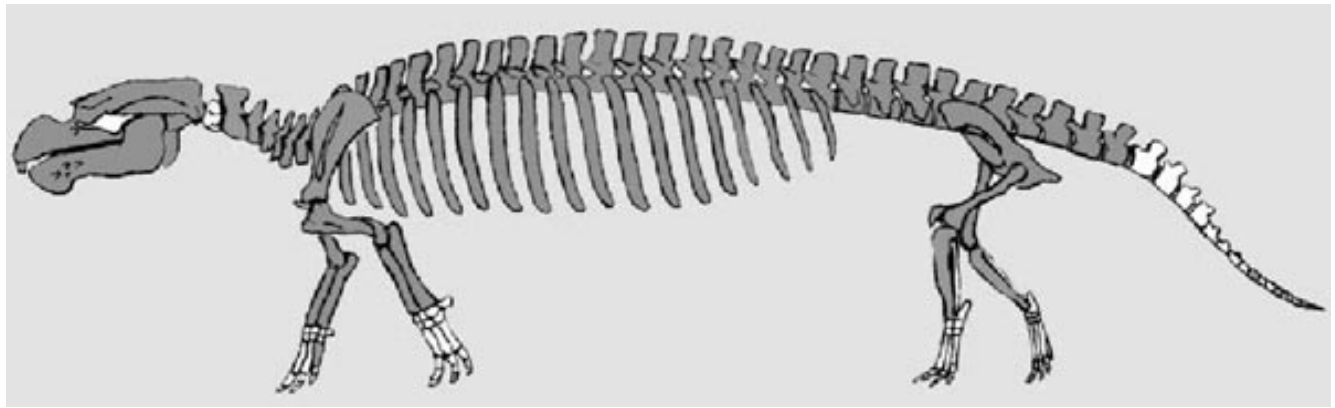

**Figure 1.4.5. An intermediate sirenian fossil: a seacow with legs.** Reconstructed skeleton of *Pezosiren portelli*. Length is approximately 7 feet. Gray coloring represents extant fossils; white elements are partly conjectural. ([Domning 2001](#); Image © 2001 Macmillan Magazines Ltd.)

Seacows (manatees and dugongs) are fully aquatic mammals with flippers for forelimbs and no hindlimbs. Evolutionary theory predicts that seacows evolved from terrestrial ancestors with legs, and that thus we could find seacow intermediates with legs. Recently, a new transitional fossil has been found in Jamaica, a seacow with four legs ([Domning 2001](#)).

There are many other examples such as these—most can be found in the excellent [Transitional Vertebrate Fossils FAQ](#).

### Potential Falsification:

Any finding of a striking half-mammal, half-bird intermediate would be highly inconsistent with common descent. Many other examples of prohibited intermediates can be thought of, based on the standard tree ([Kemp 1982](#); [Stanley 1993](#); [Carroll 1997](#); [Chatterjee 1997](#)).

A subtle, yet important point is that a strict cladistic evolutionary interpretation precludes the possibility of identifying true ancestors; only intermediates or transitionals can be positively identified. (For the purposes of this article, transitionals and intermediates are considered synonymous.) The only incontrovertible evidence for an ancestor-descendant relationship is the observation of a birth; obviously this is normally rather improbable in the fossil record. Intermediates are not necessarily the same as the exact predicted ancestors; in fact, it is rather unlikely that they would be the same. Simply due to probability considerations, the intermediates that we find will most likely not be the true ancestors of any modern species, but will be closely related to a predicted common ancestor. Therefore, the intermediates we do find will likely have additional derived characters besides the characters that identified them as intermediates. Because of these considerations, when a new and important intermediate fossil species is discovered, careful paleontologists will often note that the transitional species under study is probably not an ancestor, but rather is "representative of a common ancestor" or is an evolutionary "side-branch". The fewer extra derived characters that an intermediate fossil has, the higher the probability that an intermediate fossil is an actual ancestor. For further clarification see [prediction 5.4](#).

### Prediction 1.5: Chronological order of intermediates

Fossilized intermediates should appear in the correct general chronological order based on the standard tree. Any phylogenetic tree predicts a relative chronological order of the evolution of hypothetical common ancestors and intermediates between these ancestors. For instance, in our current example, the reptile-mammal common ancestor (B) and intermediates should be older than the reptile-bird common ancestor (A) and intermediates.

Note, however, that there is some "play" within the temporal constraints demanded by any phylogeny, for two primary reasons: (1) the statistical confidence (or conversely, the error) associated with a phylogeny and its specific internal branches, and (2) the inherent resolution of the fossil record (ultimately stemming from the vagaries of the fossilization process). As mentioned earlier, most phylogenetic trees have some branches with high confidence, because they are well-supported by the data, and other branches in which we have less confidence, because they are statistically less significant and poorly supported by the data. See also the [caveats](#) associated with phylogenetic analysis.

When evaluating the geological order of fossils, remember that once a transitional species appears there is no reason why it *must* become extinct and be replaced. For instance, some organisms have undergone little change in as much as 100 to 200 million years in rare cases. Some familiar examples are the "living fossils", such as the coelacanth, which has persisted for approximately 80 million years; the bat, which has not changed much in the past 50 million years; and even the modern tree squirrel, which has not changed in 35 million years. In fact, paleontological studies indicate the average longevity of 21 living families of vertebrates is approximately 70 million years ([Carroll 1997](#), p. 167).

Furthermore, the fossil record is demonstrably incomplete; species appear in the fossil record, then disappear, then reappear later. An exceptional instance is the coelacanth, which last appeared in the fossil record 80 million years ago, yet it is alive today. During the Cretaceous (a critical time in bird evolution), there is a 50 million-year gap in the diplodocoidean record, greater than a 40 million-year gap in the pachycephalosaurian record, greater than a 20 million-year gap in the troodontidae, and about a 15 million-year gap in the oviraptorosaurian fossil record (both of these last two orders of dinosaurs are maniraptoran coelurosaurian theropods, which figure significantly in the evolution of birds). During the Jurassic, there is a 40 million-year gap in the fossil record of the heterodontosauridae ([Serenio 1999](#)). Most organisms do not fossilize, and there is no reason why a representative of some species must be found in the fossil record. As every graduate student in scientific research knows (or eventually learns, perhaps the hard way), arguments based upon negative evidence are very weak scientific arguments, especially in the absence of proper positive controls. Thus, based on the fossil remains of modern species and the known gaps in the current paleontological records of extinct species, the observation of transitional species "out of order" by 40 million years should be fairly common. This degree of "play" in the fossil record is actually rather minor, considering that the fossil record of life spans between 2 to 3.8 billion years and that of multicellular organisms encompasses a total of ~660 million years. An uncertainty of 40 million years is equivalent to about a 1% or 6% relative error, respectively—rather small overall.

### Confirmation:

The reptile-bird intermediates mentioned above date from the Upper Jurassic and Lower Cretaceous (about 150 million years ago), whereas pelycosauria and therapsida (reptile-mammal intermediates) are older and date from the Carboniferous and the Permian (about 250 to 350 million years ago, see [the Geological Time Scale](#)). This is precisely what should be observed if the fossil record matches the standard phylogenetic tree.

The most scientifically rigorous method of confirming this prediction is to demonstrate a positive correlation between phylogeny and stratigraphy, i.e. a positive correlation between the order of taxa in a phylogenetic tree and the geological order in which those taxa first appear and last appear (whether for



living or extinct intermediates). For instance, within the error inherent in the fossil record, prokaryotes should appear first, followed by simple multicellular animals like sponges and starfish, then lampreys, fish, amphibians, reptiles, mammals, etc., as shown in [Figure 1](#). Contrary to the erroneous (and unreferenced) opinions of some anti-evolutionists (e.g. [Wise 1994](#), p. 225-226), studies from the past ten years addressing this very issue have confirmed that there is indeed a positive correlation between phylogeny and stratigraphy, with statistical significance ([Benton 1998](#); [Benton and Hitchin 1996](#); [Benton and Hitchin 1997](#); [Benton et al. 1999](#); [Benton et al. 2000](#); [Benton and Storrs 1994](#); [Clyde and Fisher 1997](#); [Hitchin and Benton 1997](#); [Huelsenbeck 1994](#); [Norell and Novacek 1992a](#); [Norell and Novacek 1992b](#); [Wills 1999](#)). Using three different measures of phylogeny-stratigraphy correlation [the RCI, GER, and SCI ([Ghosts 2.4 software](#), Wills 1999)], a high positive correlation was found between the standard phylogenetic tree portrayed in [Figure 1](#) and the stratigraphic range of the same taxa, with very high statistical significance ( $P < 0.0001$ ) (this work, *Ghosts* input file available upon request).

As another specific example, an early analysis published in *Science* by Mark Norell and Michael Novacek ([Norell and Novacek 1992b](#)) examined 24 different taxa of vertebrates (teleosts, amniotes, reptiles, synapsids, diapsids, lepidosaurs, squamates, two orders of dinosaurs, two orders of hadrosaurs, pachycephalosaurs, higher mammals, primates, rodents, ungulates, artiodactyls, ruminants, elephantiformes, brontotheres, tapiroids, chalicotheres, Chalicotheriinae, and equids). For each taxa, the phylogenetic position of known fossils was compared with the stratigraphic position of the same fossils. A positive correlation was found for *all* of the 24 taxa, 18 of which were statistically significant. Note that the correlation theoretically could have been negative. A statistically significant negative correlation would indicate that, in general, organisms rooted deeply in the phylogeny are found in more recent strata—a strong macroevolutionary inconsistency. However, no negative correlations were observed.

As a third example, Michael Benton and Rebecca Hitchin published a more recent, greatly expanded, and detailed stratigraphic analysis of 384 published cladograms of various multicellular organisms ([Benton and Hitchin 1997](#)). Using the three measures of congruence between the fossil record and phylogeny mentioned above (the RCI, GER, and SCI), these researchers observed values "skewed so far from a normal distribution [i.e. randomness] that they provide evidence for strong congruence of the two datasets [fossils and cladograms]." Furthermore, Benton and Hitchin's analysis was extremely conservative, since they made no effort to exclude cladograms with poor resolution or to exclude cladograms with very small numbers of taxa. Including both of these types of cladograms will add confounding random elements to the analysis and will decrease the apparent concordance between stratigraphy and cladograms. Even so, the results were overall extremely statistically significant ( $P < 0.0005$ ). As the authors comment in their discussion:

"... the RCI and SCI metrics showed impressive left-skewing; the majority of cladograms tested show good congruence between cladistic and stratigraphic information. Cladists and stratigraphers may breathe easy: the cladistic method appears, on the whole, to be finding phylogenies that may be close to the true phylogeny of life, and the sequence of fossils in the rocks is not misleading. ... it would be hard to explain why the independent evidence of the stratigraphic occurrence of fossils and the patterns of cladograms should show such striking levels of congruence if the fossil record and the cladistic method were hopelessly misleading." ([Benton and Hitchin 1997](#), p. 889)

Additionally, if the correlation between phylogeny and stratigraphy is due to common descent, we would expect the correlation to improve over longer geological time frames (since the relative error associated with the fossil record decreases). This is in fact observed ([Benton et al. 1999](#)). We also would expect the correlation to improve, not to get worse, as more fossils are discovered, and this has also been observed ([Benton and Storrs 1994](#)).

## Potential Falsification:

It would be highly inconsistent if the chronological order were reversed in the reptile-bird and reptile-mammal example. More generally, the strongest falsification of this prediction would be the finding that there was a *negative* correlation between stratigraphy and the phylogenetic tree that describes the genealogical relatedness of all living organisms. Even the finding that there was no overall correlation, neither positive nor negative, between stratigraphy and the consensus phylogeny of the major taxa would be very problematic for the theory of common descent. In addition, the observed correlation could decrease over longer time frames or as we acquire more paleontological data—but neither is the case ([Benton \*et al.\* 1999](#); [Benton and Storrs 1994](#)).

Based on the high confidence in certain branches of phylogenetic trees, some temporal constraints are extremely rigid. For example, we should never find mammalian or avian fossils in or before Devonian deposits, before reptiles had diverged from the amphibian tetrapod line. This excludes Precambrian, Cambrian, Ordovician, and Silurian deposits, encompassing 92% of the earth's geological history and 65% of the biological history of multicellular organisms. Even one incontrovertible find of any pre-Devonian mammal, bird, or flower would shatter the theory of common descent ([Kemp 1982](#); [Carroll 1988](#); [Stanley 1993](#); [Chatterjee 1997](#)).

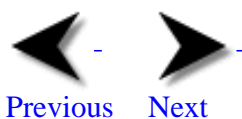

## References

- Albert, J., Wahlberg, J., Leitner, T., Escanilla, D. and Uhlen, M. (1994) "Analysis of a rape case by direct sequencing of the human immunodeficiency virus type 1 pol and gag genes." *J Virol* 68: 5918-24. [\[PubMed\]](#)
- Archie, J. W. (1989) "A randomization test for phylogenetic information in systematic data." *Systematic Zoology* 38: 219-252.
- Arnold, C., Balfe, P. and Clewley, J. P. (1995) "Sequence distances between env genes of HIV-1 from individuals infected from the same source: implications for the investigation of possible transmission events." *Virology* 211: 198-203. [\[PubMed\]](#)
- Atchely, W. R., and Fitch, W. M. (1991) "Gene trees and the origins of inbred strains of mice." *Science* 254: 554-558. [\[PubMed\]](#)
- Avery, O. T., MacLeod, C. M. and McCarty, M. (1944) "Studies on the chemical nature of the substance inducing transformation of pneumococcal types." *J. Exp. Med.* 79:137-158.
- Avise, J. C., and Wollenberg, K. (1997) "Phylogenetics and the origin of species." *PNAS* 94: 7748-7755. <http://www.pnas.org/cgi/content/full/94/15/7748>
- Bailey, T. L., and Gribskov, M. (1998) "Combining evidence using p-values: application to sequence homology searches. *Bioinformatics*. 14: 48-54. [\[PubMed\]](#)
- Bajpai, S. and Gingerich, P. D. (1998) "A new Eocene archaeocete (Mammalia, Cetacea) from India and the time of origin of whales." *Proc Natl Acad Sci U S A.* 95: 15464-15468. [\[PubMed\]](#)
- Baldauf, S. L., Roger, A. J., Wenk-Siefert, I., and Doolittle, W. F. (2000) "A kingdom-level phylogeny of eukaryotes based on combined protein data." *Science* 290: 972-7. [\[PubMed\]](#)

- Behe, M.J. (1994) "Experimental support for regarding functional classes of proteins to be highly isolated from each other." In **Darwinism, Science or Philosophy?** Eds. Jon Buell and Virginia Hearn, Foundation for Thought and Ethics: Houston, Texas. [[ARN Michael Behe Files](#)]
- Benton, M. J. (1998) "Molecular and morphological phylogenies of mammals: Congruence with stratigraphic data." *Molecular Phylogenetics and Evolution* 9: 398-407. [[PubMed](#)]
- Benton, M. J., and Hitchin, R. (1996) "Testing the quality of the fossil record by groups and by major habitats." *Historical Biol.* 12: 111-157.
- Benton, M. J., and Hitchin, R. (1997) "Congruence between phylogenetic and stratigraphic data on the history of life." *Proc. R. Soc. Lond. B.* 264: 885-890.
- Benton, M. J., Hitchin, R., and Wills, M. A. (1999) "Assessing congruence between cladistic and stratigraphic data." *Syst. Biol.* 48: 581-596.
- Benton, M. J., and Storrs, G. W. (1994) "Testing the quality of the fossil record: paleontological knowledge is improving." *Geology* 22: 111-114.
- Benton, M. J., Wills, M. A., and Hitchin, R. (2000) "Quality of the fossil record through time." *Nature* 403: 534-537. [[PubMed](#)]
- Birch, C. J., McCaw, R. F., Bulach, D. M., Revill, P. A., Carter, J. T., Tomnay, J., Hatch, B., Middleton, T. V., Chibo, D., Catton, M. G., Pankhurst, J. L., Breschkin, A. M., Locarnini, S. A. and Bowden, D. S. (2000) "Molecular analysis of human immunodeficiency virus strains associated with a case of criminal transmission of the virus." *J Infect Dis* 182: 941-4. <http://www.journals.uchicago.edu/JID/journal/issues/v182n3/000154/000154.html>
- Blanchard, A., Ferris, S., Chamaret, S., Guetard, D. and Montagnier, L. (1998) "Molecular evidence for nosocomial transmission of human immunodeficiency virus from a surgeon to one of his patients." *J Virol* 72: 4537-40. <http://jvi.asm.org/cgi/content/full/72/5/4537?view=full&pmid=9557756>
- Box, G. E. P. (1978) **Statistics for experimenters : an introduction to design, data analysis, and model building.** New York: John Wiley and Sons.
- Brenner, S. (1957) "On the impossibility of all overlapping triplet codes in information transfer from nucleic acid to proteins." *PNAS* 43:687-694.
- Brown, J. R., Douady, C. J., Italia, M. J., Marshall, W. E., and Stanhope, M. J. (2001) "Universal trees based on large combined protein sequence data sets." *Nature Genetics* 28: 281-285. [[PubMed](#)]
- Bryant, D., MacKenzie, A. and Steel, M. (2002). "The size of a maximum agreement subtree for random binary trees." In: **Bioconsensus II.** DIMACS Series in Discrete Mathematics and Theoretical Computer Science (American Mathematical Society). ed., M.F. Janowitz.
- Carroll, R. L. (1988) **Vertebrate Paleontology and Evolution.** New York: W. H. Freeman and Co.
- Carroll, R. L. (1997) **Patterns and Processes of Vertebrate Evolution.** Cambridge: Cambridge University Press.
- Carter, G. S. (1954) **Animal Evolution.** London: Sidgwick and Jackson.
- Chatterjee, S. (1997) **The Rise of Birds: 225 million years of evolution.** Baltimore, MD: Johns Hopkins University Press.
- Chen, P.-j., Z.-m. Dong, *et al.* (1998) "An exceptionally well-preserved theropod dinosaur from the Yixian formation of China." *Nature* 391: 147-152.
- Clyde, W. C., and Fisher, D. C. (1997) "Comparing the fit of stratigraphic and morphologic data in phylogenetic analysis."

Paleobiology 23: 1-19.

Crick, F. H. C., Barnett, L., Brenner, S., and Watts-Tobin, R. J. (1961) "General nature of the genetic code for proteins." *Nature* 192:1227-1232.

Cunningham, C. W., Omland, K. E., and Oakley, T. H. (1998) "Reconstructing ancestral character states: a critical reappraisal." *Trends in Ecology and Evolution* 13: 361-366.

Darwin, C. (1872) **The Origin of Species**. Sixth Edition. The Modern Library, New York. [[Project Gutenberg text file](#)]

Dickerson, R. E., and Timkovich, R. (1975) **cytochrome c. The Enzymes**. P. D. Boyer. New York: Academic Press. 11: 397-547.

Dodson, E. O. (1960) **Evolution: Process and Product**. New York: Reinhold Publishers.

Domning, D. P. (2001) "The earliest known fully quadrupedal sirenian." *Nature*. 413: 625-627. [[PubMed](#)]

Doolittle, W. F. (1999) "Phylogenetic Classification and the Universal Tree." *Science* 284: 2124. [[PubMed](#)]

Doolittle, W. F. (2000) "The nature of the universal ancestor and the evolution of the proteome." *Current Opinion in Structural Biology* 10: 355-358. [[PubMed](#)]

Faith, D. P., and Cranston, P. S. (1991) "Could a cladogram this short have arisen by chance alone?: on permutation tests for cladistic structure." *Cladistics* 7: 1-28.

Farris, J. S. (1989) "The retention index and the rescaled consistency index." *Cladistics* 5:417-419.

Felsenstein, J. (1982) "Numerical methods for inferring evolutionary trees." *Quart. Rev. Biol.* 57: 379-404.

Felsenstein, J. (1985) "Confidence limits on phylogenies: an approach using the bootstrap." *Evolution* 39: 783-791.

Fisher, R. A. (1990) **Statistical methods, experimental design, and scientific inference**. Bennet, J. H. ed., Oxford: Oxford University Press.

Fitch, W. M. (1970) "Distinguishing homologous from analogous proteins." *Syst. Zool.* 28: 132-163.

Futuyma, D. (1998) **Evolutionary Biology**. Third edition. Sunderland, MA: Sinauer Associates.

Galton, F. and Watson, H.W. (1874) "On the probability of the extinction of families." *Journal of the Royal Anthropological Institute* 4: 138-144.

Garavelli, J. S., Hou, Z., *et al.* (2001) "The RESID Database of protein structure modifications and the NRL-3D Sequence-Structure Database." *Nucleic Acids Research* 29: 199-201. <http://www.ncifcrf.gov/RESID/>

Gish, D. T. (1978) **Evolution? The Fossils Say No!** Public School Edition, San Diego: Creation-Life Publishers.

Gilbert, S. F. (1997) **Developmental Biology**. Fifth edition. Sinauer Associates.

Gingerich, P., Wells, N. A., Russell, D. E., and Shah, S. M. I. (1983) "Origin of whales in epicontinental remnant seas: new evidence from the early Eocene of Pakistan." *Science* 220: 403-406.

Gingerich, P., Smith, B. H., and Simons, E. L. (1990) "Hind limbs of Eocene Basilosaurus: evidence of feet in whales." *Science* 249: 154-157.

Gingerich, P., Raza, S. M., Arif, M., Anwar, M., and Zhou, X. (1994) "New whale from the Eocene of Pakistan and the origin of

cetacean swimming." *Nature* 368: 844-847.

Gingerich, P. D., Haq Mu, Zalmout, I. S., Khan, I. H., and Malkani, M. S. (2001). "Origin of whales from early artiodactyls: hands and feet of Eocene Protocetidae from Pakistan." *Science*. 293: 2239-2242. [\[PubMed\]](#)

Givnish, T.J., and Sytsma, K.J. (1997) "Consistency, characters, and the likelihood of correct phylogenetic inference." *Mol Phylogenet Evol.* 7: 320-330. [\[PubMed\]](#)

Goujon, C. P., Schneider, V. M., Grofti, J., Montigny, J., Jeantils, V., Astagneau, P., Rozenbaum, W., Lot, F., Frocrain-Herchkovitch, C., Delphin, N., Le Gal, F., Nicolas, J. C., Milinkovitch, M. C. and Deny, P. (2000) "Phylogenetic analyses indicate an atypical nurse-to-patient transmission of human immunodeficiency virus type 1." *J Virol* 74: 2525-32. <http://jvi.asm.org/cgi/content/full/74/6/2525?view=full&pmid=10684266>

Gould, S. J. (1990) "An earful of jaw." *Natural History* 3: 12-23.

Gregory, W. K. (1951) **Evolution Emerging: A survey of changing patterns from primeval life to man. Volume I.** The Macmillan Co., New York.

Groves, C. P. (2000) "The genus *Cheirogaleus*: Unrecognized biodiversity in dwarf lemurs." *International Journal of Primatology*. 21(6): 943-962.

Gura, T. (2000) "Bones, molecules ... or both?" *Nature* 406: 230-233. [\[PubMed\]](#)

Haeckel, E. (1898) **The Last Link.** London: Adam and Charles Black.

Harris, T. E. (1989) **The Theory of Branching Processes.** New York: Dover.

Hedges, S. B. (1994) "Molecular evidence for the origin of birds." *PNAS* 91: 2621-2624. <http://www.pnas.org/cgi/content/abstract/91/7/2621>

Hedges, S. B., and Poling, L. L. (1999) "A molecular phylogeny of reptiles." *Science* 283: 998-1001. [\[PubMed\]](#)

Hendy, M. D., Little, C. H. C., and Penny, D. (1984) "Comparing trees with pendant vertices labelled." *SIAM J. Appl. Math.* 44: 1054-1065.

Hillis, D. M. (1991) "Discriminating between phylogenetic signal and random noise in DNA sequences." In *Phylogenetic analysis of DNA sequences*. pp. 278-294 M. M. Miyamoto and J. Cracraft, eds. New York: Oxford University Press.

Hillis, D. M., and Bull, J. J. (1993) "An empirical test of bootstrapping as a method for assessing confidence on phylogenetic analysis." *Syst. Biol.* 42: 182-192.

Hillis, D. M., and Huelsenbeck, J. P. (1992) "Signal, noise, and reliability in molecular phylogenetic analyses." *Journal of Heredity* 83: 189-195. [\[PubMed\]](#)

Hillis, D. M., Moritz, C. and Mable, B. K. Eds. (1996) **Molecular systematics.** Sunderland, MA: Sinauer Associates.

Hinegardner, T. T., and Engelberg, J. (1963) "Rationale for a Universal Genetic Code." *Science* 142: 1083-1085.

Hitchin, R., and Benton, M. J. (1997) "Congruence between parsimony and stratigraphy: comparisons of three indices." *Paleobiology* 23: 20-32.

Hofreiter, M., Serre, D., Poinar, H. N., Kuch, M., and Paabo, S. (2001) "Ancient DNA." *Nat Rev Genet* 2: 353-359.

Holmes, E. C., Zhang, L. Q., Simmonds, P., Rogers, A. S. and Brown, A. J. (1993) "Molecular investigation of human

- immunodeficiency virus (HIV) infection in a patient of an HIV-infected surgeon." *J Infect Dis* 167: 1411-4. [\[PubMed\]](#)
- Hudson, R. R. (1992) "Gene trees, species trees and the segregation of ancestral alleles." *Genetics* 131: 509-513. [\[PubMed\]](#)
- Huelsenbeck, J. P. (1994) "Comparing the stratigraphic record to estimates of phylogeny." *Palaeobiology* 20: 470-483.
- Huelsenbeck, J. P., Ronquist, F., Nielsen, R., and Bollback, J. P. (2001) "Bayesian inference of phylogeny and its impact on evolutionary biology." *Science* 294: 2310-2314. [\[PubMed\]](#)
- Ji, Q., Norell, M. A., Gao, K-Q., Ji, S-A., and Ren, D. (2001) "The distribution of integumentary structures in a feathered dinosaur." *Nature* 410: 1084-1088. [\[PubMed\]](#)
- Judson, H. F. (1996) **The Eighth Day of Creation: Makers of the Revolution in Biology**. Expanded edition. Cold Spring Harbor Press.
- Kardong, K. V. (2002) **Vertebrates: Comparative Anatomy, Function, Evolution**. Third ed. New York: McGraw Hill.
- Klassen, G. J., Mooi, R. D., and Locke, A. (1991) "Consistency indices and random data." *Syst. Zool.* 40:446-457.
- Kemp, J. S. (1982) **Mammal-like reptiles and the origin of mammals**. New York: Academic Press.
- Kestenbaum, D. (1998) "Gravity Measurements Close in on Big G." *Science* 282: 2180-2181. <http://www.sciencemag.org/cgi/content/full/282/5397/2180>
- Krings, M., Capelli, C., Tschentscher, F., Geisert, H., Meyer, S., von Haeseler, A., Grossschmidt, K., Possnert, G., Paunovic, M., and Paabo, S. (2000) "A view of Neandertal genetic diversity." *Nat Genet* 26: 144-146.
- Lehman, N. (2001) "Please release me, genetic code." *Current Biology* 11: R63-R66. [\[PubMed\]](#)
- Li, W.-H. (1997) **Molecular Evolution**. Sunderland, MA: Sinauer Associates.
- Luo, Z.-X., Crompton, A. W. and Sun, A.-L. (2001) "A new mammaliaform from the early Jurassic and evolution of mammalian characteristics." *Science* 292: 1535-1539. [\[PubMed\]](#)
- Lyons-Weiler, J., Hoeker, G. A., and Tausch, R. J. (1996) "Relative Apparent Synapomorphy Analysis (RASA) I: The Statistical Measurement of Phylogenetic Signal." *Mol. Biol. Evol.* 13: 749-757. <http://www.molbioevol.org/cgi/content/abstract/13/6/749>
- Machuca, R., Jorgensen, L. B., Theilade, P. and Nielsen, C. (2001) "Molecular investigation of transmission of human immunodeficiency virus type 1 in a criminal case." *Clin Diagn Lab Immunol* 8: 884-90. [\[PubMed\]](#)
- Maddison, W. P., and Maddison, D. R. (1992) **MacClade**. Sunderland, MA: Sinauer Associates.
- Maley, L. E., and Marshall, C. R. (1998) "The coming age of molecular systematics." *Science* 279: 505-506. [\[PubMed\]](#)
- McLaughlin, P. J., and Dayhoff, M. O. (1973) "Eukaryote evolution: a view based on cytochrome *c* sequence data." *Journal of Molecular Evolution* 2: 99-116.
- Nichols, R. (2001) "Gene trees and species trees are not the same." *Trends Ecol Evol.* 16: 358-364. [\[PubMed\]](#)
- Norell, M. A., and Clarke, J. A. (2001) "Fossil that fills a critical gap in avian evolution." *Nature* 409: 181-184. [\[PubMed\]](#)
- Norell, M. A., Ji, Q., Gao, K., Yuan, C., Zhao, Y., and Wang, L. (2002) "'Modern' feathers on a non-avian dinosaur." *Nature* 416: 36-37. [\[PubMed\]](#)

- Norell, M. A. and Novacek, M. J. (1992a) "Congruence between superpositional and phylogenetic patterns: Comparing cladistic patterns with fossil records." *Cladistics* 8: 319-337.
- Norell, M. A. and Novacek, M. J. (1992b) "The fossil record and evolution: Comparing cladistic and paleontologic evidence for vertebrate history." *Science* 255: 1690-93.
- Norris, J. R. (1997) **Markov Chains**. Cambridge: Cambridge University Press.
- Osborn, H. F. (1918) **The Origin and Evolution of Life**. New York: Charles Scribner's Sons.
- Ou, C. Y., Ciesielski, C. A., Myers, G., Bandea, C. I., Luo, C. C., Korber, B. T., Mullins, J. I., Schochetman, G., Berkelman, R. L., Economou, A. N. and *et al.* (1992) "Molecular epidemiology of HIV transmission in a dental practice." *Science* 256: 1165-71. [\[PubMed\]](#)
- Patterson, C., Williams, D., and Humphries, C. (1993) "Congruence between molecular and morphological phylogenies." *Annual Review of Ecology and Systematics* 24: 153-188.
- Pei, M. (1949) **The Story of Language**. Philadelphia: Lippincott.
- Penny, D., and Hendy, M. D. (1986) "Estimating the reliability of phylogenetic trees." *Mol. Biol. Evol.* 3: 403-417. <http://www.molbioevol.org/cgi/content/abstract/3/5/403>
- Penny, D., Foulds, L. R., and Hendy, M. D. (1982) "Testing the theory of evolution by comparing phylogenetic trees constructed from five different protein sequences." *Nature* 297: 197-200.
- Penny, D., Hendy, M. D., and Steel, M. A. (1991) "Testing the theory of descent." In **Phylogenetic Analysis of DNA Sequences**, eds. Miyamoto, M. and Cracraft, J., New York: Oxford University Press. pp. 155-183.
- Qiang, J., Currie, P. J. *et al.* (1998) "Two feathered dinosaurs from northeastern China." *Nature* 393: 753-761.
- Quinn, T. (2000) "Measuring big G." *Nature* 408: 919-921.
- Rasoloarison, R. M., Goodman, S. M., and Ganzhorn, J. U. (2000) "Taxonomic revision of mouse lemurs (*Microcebus*) in the western portions of Madagascar." *International Journal of Primatology*. 21(6): 963-1019.
- Ringe, D. (1999) "Language classification: scientific and unscientific methods." in **The Human Inheritance**, ed. B. Sykes. Oxford: Oxford University Press, pp. 45-74.
- Rozenski, J., Crain, P. F. *et al.* (1999) "The RNA Modification Database: 1999 update." *Nucleic Acids Research* 27: 196-197. <http://medlib.med.utah.edu/RNAmods/>
- Sereno, P. C. (1999) "The Evolution of Dinosaurs." *Science* 284: 2137-2147. [\[PubMed\]](#)
- Stanley, S. (1993) **Earth and Life Through Time**. New York: W. H. Freeman.
- Steel, M. A., and Penny, D. (1993) "Distributions of tree comparison metrics—some new results." *Systematic Biology* 42: 126-141.
- Strait, D. S., Grine, F. E., and Moniz, M. A. (1997) "A reappraisal of early hominid phylogeny." *J Hum Evol* 32: 17-82.
- Swofford, D. L., Olsen, G. J., Waddell, P. J., and Hillis, D. M. (1996) "Phylogenetic inference." In **Molecular Systematics**, pp 407-514. Hillis, D. M., Moritz, C. and Mable, B. K. eds., Sunderland, Massachusetts: Sinauer.
- Thalmann, . U., and Geissmann, T. (2000) "Distribution and geographic variation in the western woolly lemur (*Avahi occidentalis*) with description of a new species (*A. unicolor*)." *International Journal of Primatology*. 21(6): 915-941.

- Thewissen, J. G., Williams, E. M., Roe, L. J., and Hussain, S. T. (2001) "Skeletons of terrestrial cetaceans and the relationship of whales to artiodactyls." *Nature*. 413: 277-281. [\[PubMed\]](#)
- van Roosmalen, M. G. M., van Roosmalen, T., Mittermeier, R. A., and Rylands, A. B. (2000) "Two new species of marmoset, genus *Callithrix Erxleben, 1777* (*Callitrichidae*, Primates), from the Tapajos/Madeira interfluvium, south central Amazonia." *Neotropical Primates* 8(1): 2-18.
- Veenstra, J., Schuurman, R., Cornelissen, M., van't Wout, A. B., Boucher, C. A., Schuitemaker, H., Goudsmit, J. and Coutinho, R. A. (1995) "Transmission of zidovudine-resistant human immunodeficiency virus type 1 variants following deliberate injection of blood from a patient with AIDS: characteristics and natural history of the virus." *Clin Infect Dis* 21: 556-60. [\[PubMed\]](#)
- Voet, D., and Voet, J. (1995) **Biochemistry**. New York: John Wiley and Sons.
- Vogel, G. (1997) "Phylogenetic analysis: getting its day in court." *Science* 275: 1559-60. [\[PubMed\]](#)
- Wadsworth, H. M. (1997) **Handbook of statistical methods for engineers and scientists**. New York: McGraw-Hill Pub. Co.
- Wang, Y. Hu, Y., Meng, J. and Li, C. (2001) "An ossified meckel's cartilage in two Cretaceous mammals and origin of the mammalian middle ear." *Science* 294: 357-361. [\[PubMed\]](#)
- Wills, M. A. (1999) "Congruence between phylogeny and stratigraphy: Randomization tests and the gap excess ratio." *Syst. Biol.* 48: 559-580.
- Wilson, E. O. (1992) **The Diversity of Life**. Cambridge, MA, Harvard University Press.
- Wise, K. P. (1994) "The Origin of Life's Major Groups." In **The Creation Hypothesis**, pp. 211-234. Moreland, J. P. ed., Downers Grove, IL: InterVarsity Press.
- Woese, C. (1998) "The universal ancestor." *PNAS* 95: 6854-6859. <http://www.pnas.org/cgi/content/full/95/12/6854>
- Wu, C. I. (1991) "Inferences of species phylogeny in relation to segregation of ancient polymorphisms." *Genetics* 127: 429-435. [\[PubMed\]](#)
- Xu, X., Tang, Z-T., Wang, X-l. (1999) "A therizinosauroid dinosaur with integumentary structures from China." *Nature* 399: 350-354.
- Xu, X., Zhou, Z., and Wang, X. (2000) "The smallest known non-avian theropod dinosaur." *Nature* 408: 705-708 [\[PubMed\]](#)
- Xu, X., Norell, M. A., Wang, X-l., Makovicky, P. J., and Wu, X.C. (2002) "A basal troodontid from the Early Cretaceous of China." *Nature* 415: 780-784. [\[PubMed\]](#)
- Yirell, D. L., Robertson, P., Goldberg, D. J., McMenamin, J., Cameron, S. and Leigh Brown, A. J. (1997) "Molecular investigation into outbreak of HIV in a Scottish prison." *Bmj* 314: 1446-50. <http://bmj.com/cgi/content/full/314/7092/1446?view=full&pmid=9167560>
- Yockey, H. P. (1992) **Information Theory and Molecular Biology**. New York: Cambridge University Press.
- Yoder, A. D., Rasoloarison, R. M., Goodman, S. M., Irwin, J. A., Atsalis, S., Ravosa, M. J., and Ganzhorn, J. U. (2000) "Remarkable species diversity in Malagasy mouse lemurs (primates, *Microcebus*)." *Proc Natl Acad Sci* 97(21): 11325-30. <http://www.pnas.org/cgi/content/full/97/21/11325>
- Zhu, T., B. Korber, *et al.* (1998) "An African HIV-1 sequence from 1959 and implications for the origin of the epidemic." *Nature* 391: 594-597. [\[PubMed\]](#)



Zuckerkindl, E. and Pauling, L. (1965) "Evolutionary Divergence and Convergence in Proteins." in **Evolving Genes and Proteins: a symposium held at the Institute of Microbiology of Rutgers, with support from the National Science Foundation**. Eds Vernon Bryson and Henry J. Vogel. New York: Academic Press.

[Full references](#)

[Glossary](#)

 -   
[Previous](#)   [Next](#)

Home	Browse	Search	Feedback	Links
The FAQ	Must-Read Files		Index	
Evolution	Creationism		Age of the Earth	
Flood Geology	Catastrophism		Debates	

[Home Page](#) | [Browse](#) | [Search](#) | [Feedback](#) | [Links](#)



[The FAQ](#) | [Must-Read Files](#) | [Index](#) | [Creationism](#) | [Evolution](#) | [Age of the Earth](#) | [Flood Geology](#) | [Catastrophism](#) | [Debates](#)

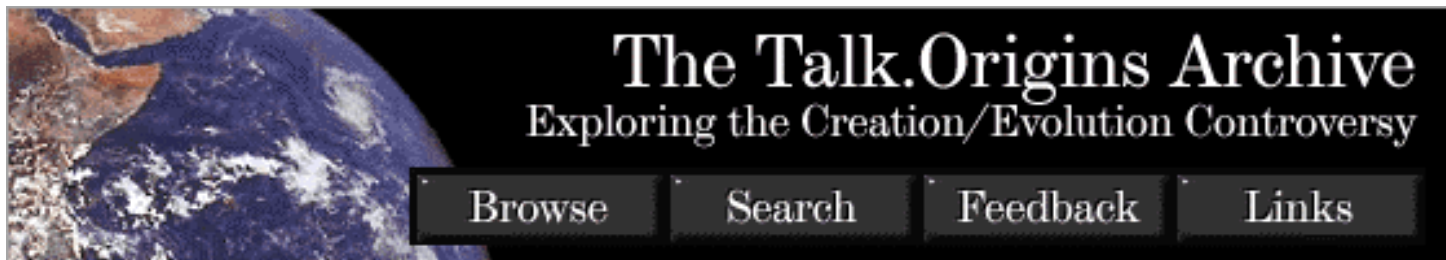

## 29+ Evidences for Macroevolution

### Part 2: Past History

Copyright &copy; 1999-2004 by [Douglas Theobald, Ph.D.](#)



[Previous](#)

[Contents](#)

[Next](#)

**B**y studying the standard phylogenetic tree, it can be seen that every species has a unique genealogical history. Each species has a unique series of common ancestors linking it to the original common ancestor. We should expect that organisms carry evidence of this history and ancestry with them. The standard phylogenetic tree predicts what historical evidence is possible and what is impossible for each given species.

### Part 2 Outline

1. [Anatomical vestigial structures](#)
  - o [Answers to criticisms of vestigial structures](#)
    1. [Vestiges can have functions](#)
    2. [Positive evidence demonstrates lack of functionality](#)
    3. [Negative evidence is scientific when controlled](#)
2. [Atavisms](#)
  - o [Living whales with hindlimbs](#)
  - o [Newborn babies with tails](#)
3. [Molecular vestigial structures](#)
4. [Ontogeny and developmental biology](#)
  - o [Mammalian ear bones and reptile jaws](#)
  - o [Pharyngeal pouches and branchial arches](#)

- [Snake and whale embryos and with legs](#)
  - [Embryonic human tail](#)
  - [Marsupial eggshell and caruncle](#)
5. [Present biogeography](#)
  6. [Past biogeography](#)
    - [Marsupials](#)
    - [Horses](#)
    - [Apes and humans](#)

## Prediction 2.1: Anatomical vestiges

"The wing of the ostrich resembles those of the gyrfalcon and the hawk. Who does not know how the speed of the gyrfalcon and hawk in flight exceeds that of other birds? The ostrich certainly has wings like theirs but not their speed of flight. Truly, it has not the capacity to be lifted from the ground and gives only the impression of spreading its wings as if to fly; however, it never supports itself above the earth in flight.

It is exactly the same with all those hypocrites who pretend to live a life of piety, giving the impression of holiness without the reality of holy behaviour."

### [The Aberdeen Bestiary](#)

Folio 41v , c. AD 1200

— *on the ostrich, its vestiges a symbol of hypocrisy since the 2nd century A.D.*

Some of the most renowned evidence for evolution are the various nonfunctional or rudimentary [vestigial](#) characters, both anatomical and molecular, that are found throughout biology. A vestige is defined, independently of evolutionary theory, as a reduced and rudimentary structure compared to the same complex structure in other organisms. Vestigial characters, if functional, perform relatively simple, minor, or inessential functions using structures that were clearly designed for other complex purposes. Though many vestigial organs have no function, complete non-functionality is not a requirement for vestigiality ([Crapo 1985](#); [Culver et al. 1995](#); [Darwin 1872](#), pp. 601-609; [Dodson 1960](#), p. 44; [Griffiths 1992](#); [Hall 2003](#); [McCabe 1912](#), p. 264; [Merrell 1962](#), p. 101; [Moody 1962](#), p. 40; [Muller 2002](#); [Naylor 1982](#); [Strickberger 2000](#); [Weismann 1886](#), pp. 9-10; [Wiedersheim 1893](#), p. 2, p. 200, p. 205).

For example, wings are very complex anatomical structures specifically adapted for powered flight, yet ostriches have flightless wings. The vestigial wings of ostriches may be used for relatively simple functions, such as balance during running and courtship displays



**Figure 2.1.1. Vestigial structures of various organisms.**

From top to bottom:  
 A. A hypocritical ostrich with its wings extended.  
 B. A blind cave salamander - look closely for the eyes buried underneath the skin.  
 C. *Astyanax mexicanus*, the Mexican tetra, a blind cave fish.

—a situation akin to hammering tacks with a computer keyboard. The specific complexity of the ostrich wing indicates a function which it does not perform, and it performs functions incommensurate with its complexity. Ostrich wings are not vestigial because they are useless structures *per se*, nor are they vestigial simply because they have different functions compared to wings in other birds. Rather, what defines ostrich wings as vestigial is that they are rudimentary wings which are useless as wings.

Vestigial structures have perplexed naturalists throughout history and were noted long before Darwin first proposed universal common descent. Many eighteenth and nineteenth century naturalists identified and discussed vestigial structures, including Johann Wolfgang von Goethe (1749-1832), Georges-Louis Leclerc, Comte de Buffon (1707-1788), and Georges Cuvier (1769-1832). Over sixty years before Darwin's publication of *On the Origin of Species*, the eminent French anatomist Geoffroy St. Hilaire (1772-1844) discussed his observations of the vestigial wings of the [cassowary](#) and ostrich during his travels with Napoleon to Egypt:

"There is another species that, like the ostrich, never leaves the ground, the Cassowary, in which the shortening [of the wing] is so considerable, that it appears little more than a vestige of a wing. Its arm is not, however, entirely eliminated. All of the parts are found under the skin. ...

Whereas useless in this circumstance, these rudiments of the furcula have not been eliminated, because Nature never works by rapid jumps, and She always

leaves vestiges of an organ, even though it is completely superfluous, if that organ plays an important role in the other species of the same family. Thus, under the skin of the Cassowary's flanks are the vestiges of the wings ..." ([Geoffroy 1798](#))

Geoffroy was at a loss for why exactly nature "always leaves vestiges of an organ", yet he could not deny his empirical observations. Ten years later, Jean-Baptiste Lamarck (1744-1829) identified several vestigial structures in his *Zoological Philosophy* ([Lamarck 1809](#), pp. 115-116):

"Eyes in the head are characteristic of a great number of different animals, and essentially constitute a part of the plan of organisation of the vertebrates. Yet the mole, whose habits require a very small use of sight, has only minute and hardly visible eyes ...

Olivier's *Spalax*, which lives underground like the mole, and is apparently exposed to daylight even less than the mole, has altogether lost the use of sight: so that it shows nothing more than vestiges of this organ. Even these vestiges are entirely hidden under the skin and other parts, which cover them up and do not leave the slightest access to light.

The *Proteus*, an aquatic reptile allied to the salamanders, and living in deep dark caves under water, has, like the *Spalax*, only vestiges of the organ of sight, vestiges which are covered up and hidden in the same way." ([Lamarck 1809](#), p. 116)

Even Aristotle discussed the peculiar vestigial eyes of moles in the fourth century B.C. in *De animalibus historiae* (lib. I cap. IX), in which he identified them as "stunted in development" and "eyes not in the full sense".

As these individuals noted, vestiges can be especially puzzling features of organisms, since these "hypocritical" structures profess something that they do not do—they clearly appear designed for a certain function which they do not perform. However, common descent provides a scientific explanation for these peculiar structures. Existing species have different structures and perform different functions. If all living organisms descended from a common ancestor, then both functions and structures necessarily have been gained and lost in each lineage during macroevolutionary history. Therefore, from common descent and the constraint of gradualism, we predict that many organisms should retain vestigial structures as structural remnants of lost functions. Note that the

exact evolutionary mechanism which created a vestigial structure is irrelevant as long as the mechanism is a gradual one.

## Confirmation:

There are many examples of rudimentary and nonfunctional vestigial characters carried by organisms, and these can very often be explained in terms of evolutionary histories. For example, from independent phylogenetic evidence, snakes are known to be the descendants of four-legged reptiles. Most pythons (which are legless snakes) carry vestigial pelvises hidden beneath their skin ([Cohn 2001](#); [Cohn and Tickle 1999](#)).

The vestigial pelvis in pythons is not attached to vertebrae (as is the normal case in most vertebrates), and it simply floats in the abdominal cavity. Some lizards carry rudimentary, vestigial legs underneath their skin, undetectable from the outside ([Raynaud and Kan 1992](#)).

Many cave dwelling animals, such as the fish *Astyanax mexicanus* (the Mexican tetra) and the salamander species *Typhlotriton spelaeus* and *Proteus anguinus*, are blind yet have rudimentary, vestigial eyes ([Besharse and Brandon 1976](#); [Durand et al. 1993](#); [Jeffery 2001](#); [Kos et al. 2001](#)). The eyes of the Mexican tetra have a lens, a degenerate retina, a degenerate optic nerve, and a sclera, even though the tetra cannot see ([Jeffery 2001](#)). The blind salamanders have eyes with retinas and lenses, yet the eyelids grow over the eye, sealing them from outside light ([Durand et al. 1993](#); [Kos et al. 2001](#)).

Dandelions reproduce without fertilization (a condition known as *apomixis*), yet they retain flowers and produce pollen (both are sexual organs normally used for sexual fertilization) ([Mes et al. 2002](#)). Flowers and pollen are thus useless characters for dandelions in terms of sexual reproduction.

There are many examples of flightless beetles (such as the weevils of the genus *Lucanidae*) which retain perfectly formed wings housed underneath fused wing covers. All of these examples can be explained in terms



**Figure 2.1.2. Various organisms displaying vestigial characters.** From top to bottom: A. *Apterocyclus honolulensis*, a flightless weevil. The black wing covers cannot open, as they are fused, yet

of the beneficial functions and structures of the organisms' predicted ancestors ([Futuyma 1998](#), pp. 122-123).

underneath are perfectly formed beetle wings. B. The vestigial flower of *Taraxacum officinale*, the common dandelion. C. A vestigial pollen grain from the dandelion.

The ancestors of humans are known to have been herbivorous, and molar teeth are required for chewing and grinding plant material. Over 90% of all adult humans develop third molars (otherwise known as wisdom teeth). Usually these teeth never erupt from the gums, and in one third of all individuals they are malformed and impacted ([Hattab et al. 1995](#); [Schersten et al. 1989](#)). These useless teeth can cause significant pain, increased risk for injury, and may result in illness and even death ([Litonjua 1996](#); [Obiechina et al. 2001](#); [Rakprasitkul 2001](#); [Tevepaugh and Dodson 1995](#)).

Another vestige of our herbivorous ancestry is the vermiform appendix. While this intestinal structure may retain a function of some sort, perhaps in the development of the immune system, it is a rudimentary version of the much larger caecum that is essential for digestion of plants in other mammals. For a detailed discussion of the vestigiality of the human vermiform appendix, see [The vestigiality of the human vermiform appendix: A modern reappraisal](#).

Yet another human vestigial structure is the coccyx, the four fused caudal vertebrae found at the base of the spine, exactly where most mammals and many other primates have external tails protruding from the back. Humans and other apes are some of the only vertebrates that lack an external tail as an adult. The coccyx is a developmental remnant of the embryonic tail that forms in humans and then is degraded and eaten by our immune system (for more detail see the sections on the [embryonic human tail](#) and the [atavistic human tail](#)). Our internal tail is unnecessary for sitting, walking, and elimination (all of which are functions attributed to the coccyx by many anti-evolutionists). The caudal vertebrae of the coccyx can cause extreme and unnecessary chronic pain in some unfortunate people, a condition called [coccydynia](#). The entire coccyx can be [surgically removed without any ill effects](#) (besides surgical complications), with the only complaint, in a small fraction of patients, being that the removal of the coccyx sadly did not remove their pain ([Grossovan and Dam 1995](#); [Perkins et al. 2003](#); [Postacchini Massobrio 1983](#); [Ramsey et al. 2003](#); [Shaposhnikov 1997](#); [Wray 1991](#)). Our small, rudimentary, fused caudal vertebrae might have some minor and inessential functions, but these vertebrae are useless for balance and grasping, their usual functions in other mammals.

### Potential Falsification:

No organism can have a vestigial structure that was not previously functional in one of its ancestors. Thus, for each species, the standard phylogenetic tree makes a huge number of predictions about vestigial characters that are allowed and those that are impossible for

any given species.

Shared derived characters and molecular sequence data, not vestigial characters, determine the phylogeny and the characteristics of predicted common ancestors. Thus, if common descent is false, vestigial characters very possibly could lack an evolutionary explanation. For example, whales are classified as mammals according to many criteria, such as having mammary glands, a placenta, one bone in the lower jaw, etc. Snakes likewise are classified as reptiles by several other derived features. However, it is theoretically possible that snakes or whales could have been classified as fish (as Linnaeus originally did). If this were the case, the vestigial legs of whales or the vestigial pelvises of snakes would make no sense evolutionarily and would be inconsistent with common descent.

It follows, then, that we should never find vestigial nipples or a vestigial incus bone in any amphibians, birds, or reptiles. No mammals should be found with vestigial feathers. No primates should ever be found with vestigial horns or degenerate wings hidden underneath the skin of the back. We should never find any arthropods with vestigial backbones. Snakes may occasionally have vestigial legs or arms, but they should never be found with small, vestigial wings. Humans may have a vestigial caecum, since we are descendants of herbivorous mammals, but neither we nor any other primate can have a vestigial gizzard like that found in birds. *Mutatis mutandis ad infinitum*.

### Criticisms:

This prediction is not falsified by finding a complex or essential function for the presumed vestigial structure. Should data of this sort be found, the structure merely becomes an example of [parahomology](#) (considered in [prediction 3.1](#)) or, more likely, an example of inefficient design (considered in [prediction 3.5](#)). Observations that would be truly inconsistent with the concept of vestigiality are given above. More detailed and specific explanations of how to demonstrate that the human appendix is not vestigial are given in the [Vestigiality of the human vermiform appendix](#) FAQ.

Many anti-evolutionist authors have erroneously concluded that vestigial structures do not exist. They reason that either (1) vestigial organs are actually functional or (2) it is theoretically impossible to demonstrate that a structure has no [function](#) (for example, see [Ham et al. 1990](#); [Batten and Sarfati 2003](#); [Bergman and Howe 1990](#); [Morris 1986](#)). This latter argument is based upon the false premise that negative results are used to demonstrate a lack of function, and that negative evidence is unscientific. These arguments are faulty for three reasons, each discussed below.

1. [Vestiges can have functions](#)
2. [Positive evidence demonstrates lack of functionality](#)



3. [Negative evidence is scientific when controlled](#)

1. Vestiges can be functional

First, and most importantly, this line of argumentation is beside the point, since it is unnecessary for vestiges to lack a function (see [Muller 2002](#) for a modern discussion of the vestigial concept that specifically includes functionality). Many true vestiges are functional (for many examples see [Culver et al. 1995](#)). In popular usage "vestigial" is often believed to be synonymous with "nonfunctional", and this confusion unfortunately has been propagated via poorly-worded definitions found in many non-technical dictionaries and encyclopedias. Even some professional research biologists have fallen prey to this oversimplification of the vestigial concept (for instance, [Scadding 1981](#), often quoted by anti-evolutionists and discussed in the [Citing Scadding \(1981\) and Misunderstanding Vestigiality](#) FAQ). The statement that vestigial structures are functionless is a convenient, yet strictly incorrect, approximation. It is analogous to the common, yet strictly incorrect, scientific claim that the earth is a sphere.

Several evolution deniers have falsely claimed that biologists changed the definition of vestigial and rudimentary structures when functions were found for many vestiges (see [Bergman and Howe 1990](#), pp. 2-3; [Sarfati, J. 2002](#)). For example, *Answers in Genesis'* Jonathan Sarfati states:

**Historical definitions of 'Vestigial' including functionality**

*The World Book Encyclopedia 2000*  
says: 'Vestigial organs are the useless remains of organs that were once useful in an organism.'

---

See quotes at left from Darwin 1859 and 1872, Weismann 1886, and Wiedersheim 1893.

**vestigial** *adj.* pertaining to, or of the nature of a vestige; like a mere trace of what has been; also, rudimentary or biologically *vestigial* has a specific application to those organs or structures which are commonly called rudimentary, and are rudimentary in fact, but which are properly regarded, not as beginnings or incipient states, but as remains of parts or structures which have been better developed in an earlier stage of existence of the same organism, or in lower preceding organisms, and have aborted or atrophied, or become otherwise reduced or rudimental in the evolution of the individual or of the species.

**(The Century Dictionary: An Encyclopedic Lexicon of the English Language 1911)**  
simply 'reduced or altered in function.'

"Vestigial organs are sometimes pressed into a secondary use when their original function has been lost."  
**(The Story of Evolution, Joseph McCabe, 1912, p.264)**

evolutionists **change the rules** when a rudimentary, degenerate survival of a former organ or structure.

**(Universal Dictionary of the English Language 1932)**

**vestige** *n.* 2. *Biol. Specif.*: a small, degenerate, or imperfectly developed part or organ which has been more fully developed in an earlier stage of the individual or in a past generation. (Webster's New International Dictionary of the English Language 1957)

"The Shorter Oxford English Dictionary (1993) defines 'vestigial' as 'atrophied, having become small and degenerate or imperfectly developed bodily part or organ that remains from one more fully developed in an earlier stage of the individual, in a past generation, or in closely related forms. course of evolutionists now' (Evolution: Process and Product, E. O. Dodson, 1960)

**vestige** *n.* 2. A small and degenerate or imperfectly developed bodily part or organ that remains from one more fully developed in an earlier stage of the individual, in a past generation, or in closely related forms. (Webster's Seventh New Collegiate Dictionary 1963)

**vestige** *n.* 2. A small or degenerate, tho ancestrally well developed. **vestigial** *adj.* 1. Having become small or degenerate: representing a structure or structures once more completely functional activity. (Funk and Wagnall's New Standard Dictionary of the English Language 1964)

"It is inconsistent to be vestigial an organ must be non-functional ... it is not essential that a vestigial organ consist without function." (Naylor 1988) might now be called 'vestigial.'

**vestige** A degenerate anatomical structure or organ that remains from one more fully developed and functional in an earlier phylogenetic form of the individual. (Dictionary of Biology 1997)

**vestigial** Occurring in a rudimentary condition, as a result of evolutionary reduction from a more elaborated, functional character state in an ancestor. (Futuyma 1998, from the Glossary)

### Vestigial Organs and Structures

Vestigial organs and structures (also called vestigia, rudiments, or remnants) are reduced body parts or organs, often without visible function in the derived bearers, that were fully developed and functioning in earlier members of that phylogenetic lineage. These structures, sometimes described as atrophied or degenerate, are usually small in comparison with their relative size in ancestral generations or in closely related species. ... vestigial structures may have acquired new, less obvious functions that differ from the original ones. Hence, a vestigium should not generally be considered without function, or *only* with respect to its ancestral, adult roles.

(Encyclopedia of Evolution 2002, pp 1131-1133)

**vestige** *noun* 2: a bodily part or organ that is small and degenerate or imperfectly developed in comparison to one more fully developed in an earlier stage of the individual, in a past generation, or in closely related forms. (Merriam-Webster Dictionary 2003)

**Vestiges** The feature is an adult remnant of a feature (a homologue) that is more fully formed in an ancestor and/or in a related taxon. Evidence of a vestige is some element of phylogenetic continuity of

the feature and shared developmental mechanisms with ancestral or related taxa that have the fully formed feature. Vestiges either are non-functional or may have a different function from the fully formed ancestral feature. If fully developed, the adult feature would be classified as a homologue. (Hall 2003)

Sarfati's arguments are invalid for several reasons.

First, even if biologists truly had changed the definition of 'vestige', why would that be a problem in science? It would not—all science changes as new data is acquired and theories become clarified. Using Sarfati's logic we would reject modern theories like Einstein's theory of relativity, since "physicists changed the rules at whim when they lost".

Second, Sarfati quotes terse, layman's definitions from a popular dictionary and a children's encyclopedia as if they were scientific authorities. It is highly likely that the person who wrote those definitions was not an evolutionary biologist. For all we know, it even may have been an anti-evolutionist or young earth creationist! Any true scientist (or legitimate scholar of any sort) would consult an advanced scientific text for definitions of technical terms, especially when attempting to criticize them. In this case, the two-volume *Encyclopedia of Evolution* (Muller 2002), with technical discussions written by real practicing research biologists, would be one of many appropriate sources.

Third, regardless of popular misconception, from the beginning of modern evolutionary theory a complete absence of function has not been a requirement for vestigiality (Crapo 1985; Culver *et al.* 1995; Darwin 1872, pp. 601-609; Dodson 1960, p. 44; Griffiths 1992; McCabe 1912, p. 264; Merrell 1962, p. 101; Moody 1962, p. 40; Muller 2002; Naylor 1982; Strickberger 2000; Weismann 1886; Wiedersheim 1893, p. 2, p. 200, p. 205). Sarfati's claim is based upon ignorance, and he of course provides no historical references showing that evolutionary biologists actually changed the definition. As an obvious counterexample, Charles Darwin never claims vestigial organs must be functionless. In his famous section on vestigial organs in *On the Origin of Species*, written nearly 150 years ago, Darwin in fact emphasizes that vestiges can be functional and gives several examples:

"Useful organs, however little they may be developed, *unless we have reason to suppose that they were formerly more highly developed*, ought not to be considered as rudimentary." ([Darwin 1859](#), emphasis added)

"An organ, serving for two purposes, may become rudimentary or utterly aborted for one, even the more important purpose, and remain perfectly efficient for the other. Thus, in plants, the office of the pistil is to allow the pollen-tubes to reach the ovules protected in the ovarium at its base. The pistil consists of a stigma supported on the style; but in some Compositae, the male florets, which of course cannot be fecundated, have a pistil, which is in a rudimentary state, for it is not crowned with a stigma; but the style remains well developed, and is clothed with hairs as in other compositae, for the purpose of brushing the pollen out of the surrounding anthers. *Again, an organ may become rudimentary for its proper purpose, and be used for a distinct object*: in certain fish the swim-bladder seems to be rudimentary for its proper function of giving buoyancy, but has become converted into a nascent breathing organ or lung. *Other similar instances could be given.*" ([Darwin 1859](#) [see text]; also [Darwin 1872](#), p. 602, emphasis added)

"Rudimentary organs, on the other hand, are either quite useless, such as teeth which never cut through the gums, or almost useless, such as the wings of an ostrich, which serve merely as sails." ([Darwin 1872](#), p. 603)

"... an organ rendered, during changed habits of life, useless or injurious for one purpose, might easily be modified and used for another purpose." ([Darwin 1872](#), p. 603)

One of the most influential evolutionary biologists of the 19th century, August Weismann, wrote on functional vestiges in 1886 in his lengthy essay, "Retrogressive development in nature":

"... for, although the latter [ostrich] does not fly, it still uses its wings as aids in running swiftly over the African plains and deserts ... Retrogression is, however, not always carried so far as to do away with a structure altogether ... But not infrequently the degenerating organ can be turned to account in some other way, and then retrogression either stops just short of actual elimination, as in the case of the wings of the ostrich, or so alters and transforms the structure as to fit it for new functions ..." ([Weismann 1886](#), pp. 5-9)

As explained above, what is surprising about the functional, vestigial ostrich wing is not that the ostrich wing lacks any function whatsoever, but that it is a rudimentary wing unused for powered flight, its "proper purpose", as Darwin puts it. Even Robert Wiedersheim, the notorious cataloguer of 86 human vestigial structures, never claims that

vestigial structures must lack functions. In the introduction to *The Structure of Man*, Wiedersheim defines "vestigial" in evolutionary terms:

"Comparative morphology points not only to the essentially similar plan of organization of the bodies of all Vertebrates, ... but also to the occurrence in them of certain organs, or parts of organs, now known as 'vestigial.'

By such organs are meant those which were formerly of greater physiological significance than at present." ([Wiedersheim 1893](#), p. 2)

At the end of his book, Wiedersheim lists his 86 vestigial structures under this heading:

"B. Retrogressively modified, the Organs having become wholly or *in part* functionless, some appearing in the Embryo alone, others present during Life constantly or inconstantly. For the greater part Organs which may be rightly termed Vestigial." ([Wiedersheim 1893](#), p. 200, *emphasis added*)

"... as was pointed out in the introduction, the term vestigial, is, as a rule, only applied to such organs as have lost their original physiological significance." ([Wiedersheim 1893](#), p. 205)

Wiedersheim, writing from an evolutionary perspective, emphasizes in his definition that vestigial structures have lost their *original, greater* physiological significance, not *all* physiological significance. He never limits vestigial structures to those lacking a function and throughout the book mentions functions of many organs he labels as vestigial.

Many anti-evolutionists enjoy quoting a paper by Steven Scadding ([Scadding 1981](#)) in which he criticizes Wiedersheim's analysis of vestigial organs as evidence for evolution. Scadding's objections are based upon the false premise that vestigial structures must have no function by definition. Wiedersheim, whom Scadding is criticizing specifically, does not make that claim. Since Scadding misrepresents Wiedersheim's position and uses an incorrect definition of vestigial in general, Scadding's points are invalid. The deep problems with Scadding's paper have been corrected in the scientific literature, and anti-evolutionists who quote this paper are engaging in poor scholarship. A detailed discussion of Scadding's 1981 paper is given in the [Citing Scadding \(1981\) and Misunderstanding Vestigiality](#) FAQ.

## 2. Positive evidence is used to demonstrate lack of function

Even though the conclusion may be negative ("structure *x* has no function"), the detection of biological functionality or lack thereof is based upon positive evidence, not negative

evidence. In organismic biology, a function is a physical process performed by an organ that is necessary for the successful reproduction of the organism in a specific environment. Functions are measured in terms of reproduction and viability. An organ has no function in a given environment if the organ's presence has no statistically significant effect on reproductive success or viability. Both reproductive success and viability can be observed and measured quantitatively and are, thus, positive data.

### 3. Negative data can be used as scientific evidence

Negative evidence is certainly valid when used properly, and negative evidence is used and reported routinely in the scientific literature. The general claim that negative evidence cannot be used to test a hypothesis is a nihilistic philosophy that has no place in experimental science. Negative evidence is admissible if it is acquired with the proper experimental controls. Good experimental technique involves controlled observations, whether the evidence is positive or negative. Positive results are bolstered by negative controls; valid negative results require positive controls.

To clarify the important issue of experimental controls, consider the following analogy with physics. If it is impossible to demonstrate that a certain structure has no function, then by the same logic it is impossible to demonstrate that a given atomic element is not radioactive. However, it is well-established in physics that lead-206 is not radioactive. We know this because radioactivity is detectable from other elements, such as phosphorous-32, yet simultaneously radioactivity is undetectable from lead-206. In this physics example phosphorous-32 is a positive control, which is needed to use the negative evidence gathered from lead-206. Likewise, we can certainly demonstrate that a given structure has no function when we can simultaneously detect a function for another structure in the same environment.

## Prediction 2.2: Atavisms

- [Example 1: living whales with legs](#)
- [Example 2: newborn babies with tails](#)

Anatomical atavisms are closely related conceptually to vestigial structures. An *atavism* is the reappearance of a lost character specific to a remote evolutionary ancestor and not observed in the parents or recent ancestors of the organism displaying the atavistic character. Atavisms have several essential features: (1) presence in adult stages of life, (2) absence in parents or recent ancestors, and (3) extreme rarity in a population ([Hall 1984](#)). For developmental reasons, the occasional occurrence of atavisms is expected under common descent if structures or functions are gradually lost between ancestor and descendant lineages ([Hall 1984](#); [Hall 1995](#)). Here we are primarily concerned with potential atavistic structures that are characteristic of taxa to which the organism displaying the structure does *not* belong. As a hypothetical example, if mutant horses

occasionally displayed gills, this would be considered a potential atavism, since gills are diagnostic of taxa (e.g. fish) to which horses do not belong. As with vestigial structures, no organism can have an atavistic structure that was not previously found in one of its ancestors. Thus, for each species, the standard phylogenetic tree makes a huge number of predictions about atavisms that are allowed and those that are impossible for any given species.

## Confirmation:

Many famous examples of atavisms exist, including (1) rare formation of extra toes (2nd and 4th digits) in horses, similar to what is seen in the archaic horses *Mesohippus* and *Merychippus*, (2) atavistic thigh muscles in Passeriform birds and sparrows, (3) hyoid muscles in dogs, (4) wings in earwigs (normally wingless), (5) atavistic fibulae in birds (the fibulae are normally extremely reduced), (6) extra toes in guinea pigs and salamanders, (6) the atavistic dew claw in many dog breeds, and (7) various atavisms in humans (one described in detail below) ([Hall 1984](#)).

## Example 1: Living whales found with hindlimbs

"I knew, of course, that some modern whales have a pair of bones embedded in their tissues, each of which strengthens the pelvic wall and acts as an organ anchor. ... Whales could be born with a little extra lump of bone which evolutionists therefore insisted was a throwback corresponding to a second limb bone.

However, the spectacle of a whale being hauled out of the ocean with an actual leg hanging down from its side was a totally different issue. I don't remember my exact response, but I indicated that, if true, this would be a serious challenge to explain on the basis of a creation model." ([Wieland 1998](#))

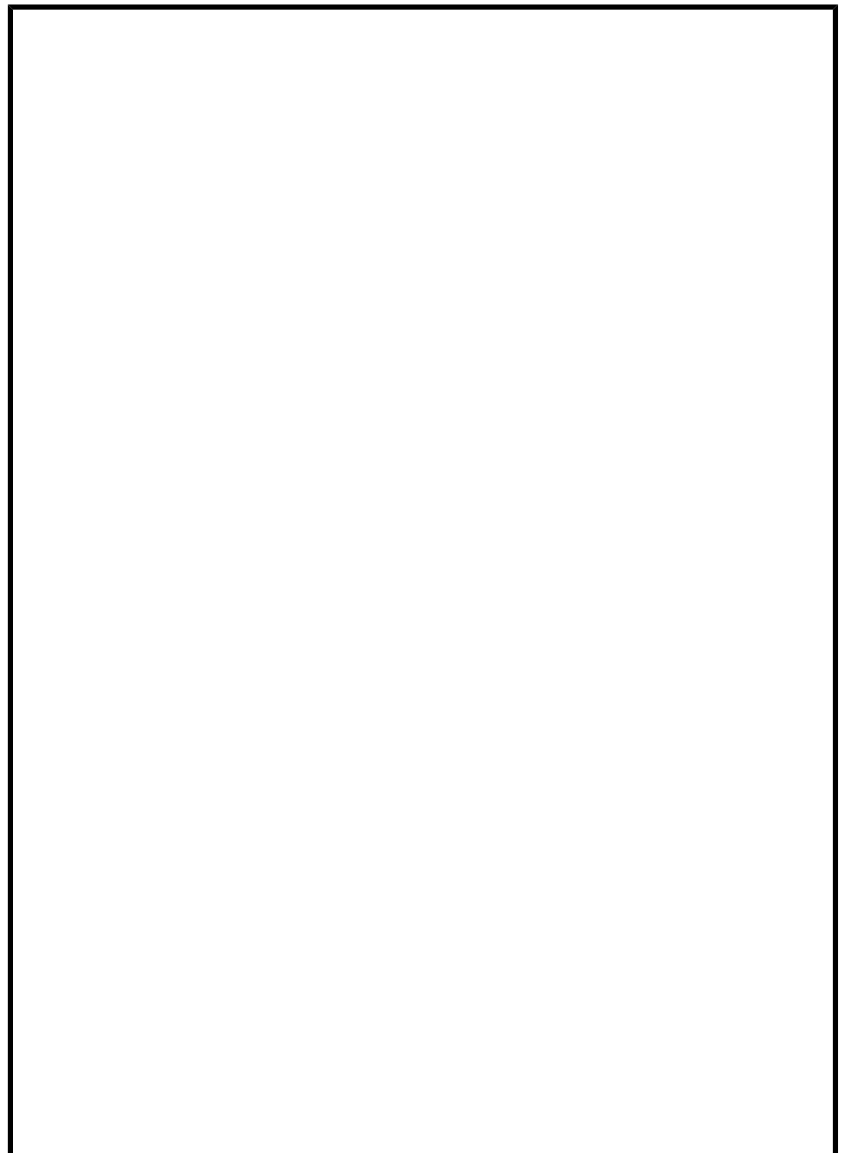

- [Carl Wieland](#)

Young earth creationist,  
CEO, [Answers in Genesis](#) -  
Australia,  
Joint CEO, [Answers in Genesis  
International](#),  
Editor, [Creation magazine](#)

Probably the most well known case of atavism is found in the whales.

According to the standard phylogenetic tree, whales are known to be the descendants of terrestrial mammals that had hindlimbs. Thus, we expect the possibility that rare mutant whales might occasionally develop atavistic hindlimbs. In fact, there are many cases where whales have been found with rudimentary atavistic hindlimbs in the wild (see [Figure 2.2.1](#); for reviews see [Berzin 1972](#), pp. 65-67 and [Hall 1984](#), pp. 90-93). Hindlimbs have been found in baleen whales ([Sleptsov 1939](#)), humpback whales ([Andrews 1921](#)) and in many specimens of sperm whales ([Abel 1908](#); [Berzin 1972](#), p. 66; [Nemoto 1963](#); [Ogawa and Kamiya 1957](#); [Zembskii and Berzin 1961](#)). Most of these examples are of whales with femurs, tibia, and fibulae; however, some even include feet with complete digits.

For example, [Figure 2.2.1](#) shows the bones from the atavistic legs of a humpback whale. These bones are the remnants of one of two symmetrical hind-limbs found protruding from the ventral side of a female humpback whale, captured by a whaling ship from the Kyuquot Station near the west coast of Vancouver Island, British Columbia, in July 1919. Two officials of the Consolidated Whaling Company were understandably impressed by this discovery, and they removed one of the legs and presented the skeletal remains to the



**Figure 2.2.1. Bones from the atavistic hind-limbs of a humpback whale.** **A.** From top to bottom, the cartilaginous femur, tibia, tarsus, and metatarsal, arranged as found in situ in the whale. **B.** Enlarged detail of the femur and tibia shown in A. (scale is not the same as A). **C.** Detail of the tarsus and metatarsal shown in A. (Image reproduced from [Andrews 1921](#), Figures 2, 3, and 4.)



Provincial Museum in Victoria, B.C. (The other leg was evidently taken as a "souvenir" by crew members of the whaling ship). The museum's director, Francis Kermode, presented the bones to Roy Chapman Andrews from the American Museum of Natural History (AMNH) in New York. Andrews reported the findings, along with photographs of the whale from the whaling crew, in *American Museum Novitates*, the journal of the AMNH. Andrews identified in the remains a shrunken cartiliginous femur, tibia, tarsus, and metatarsal. Both legs initially were over four feet long and covered in normal blubber and skin. For comparison, an average adult female humpback is around 45 feet long. The femur, composed of unossified cartilage, had shrunken from 15 inches to 4.5 inches. When attached to the whale, the femur was completely inside the body cavity and attached to the pelvic rudiments (humpback whales have vestiges of a pelvis inside the abdominal wall). This extraordinary finding is unlikely to be repeated, as the International Whaling Commission gave humpback whales worldwide protection status in 1966, after sixty years of uncontrolled human predation had decimated the population.

## Example 2: Newborn babies born with tails

Primarily due to intense medical interest, humans are one of the best characterized species and many developmental anomalies are known. There are several human atavisms that reflect our common genetic heritage with other mammals. One of the most striking is the existence of the rare "true human tail" (also variously known as "coccygeal process", "coccygeal projection", "caudal appendage", and "vestigial tail"). More than 100 cases of human tails have been reported in the medical literature. Less than one third of the well-documented cases are what are medically known as "pseudo-tails" ([Dao and Netsky 1984](#); [Dubrow et al. 1988](#)). Pseudo-tails are not true tails; they are simply lesions of various types coincidentally found in the caudal region of newborns, often associated with the spinal column, coccyx, and various malformations.

In contrast, the true atavistic tail of humans results from incomplete regression of the most distal end of the normal embryonic tail found in the developing human fetus (see [Figure 2.4.1](#) and the [discussion below](#) on the development of the normal human embryonic tail; [Belzberg et al. 1991](#); [Dao and Netsky 1984](#); [Grange et al. 2001](#); [Keith 1921](#)). Though formally a malformation, the true human tail is usually benign in nature ([Dubrow et al. 1988](#); [Spiegelmann et al. 1985](#)). The true human tail is characterized by a complex arrangement of adipose and connective tissue, central bundles of longitudinally arranged striated muscle in the core, blood vessels, nerve fibres, nerve ganglion cells, and specialized pressure sensing nerve organs (Vater-Pacini corpuscles). It is covered by normal skin, replete with hair follicles, sweat glands, and sebaceous glands ([Dao and Netsky 1984](#); [Dubrow et al. 1988](#); [Spiegelmann et al. 1985](#)). True human tails range in length from about one inch to over 5 inches long (on a newborn baby), and they can move via voluntary striped muscle contractions in response to various emotional states ([Baruchin et al. 1983](#); [Dao and Netsky 1984](#); [Harrison 1901](#); [Keith 1921](#); [Lundberg et al.](#)

1962).

Although human tails usually lack skeletal structures (some medical articles have claimed that true tails never have vertebrae), several human tails have also been found with cartilage and up to five, well-developed, articulating vertebrae (see [Figure 2.2.2](#); [Bar-Maor et al. 1980](#); [Dao and Netsky 1984](#); [Fara 1977](#); [Sugumata et al. 1988](#)). However, caudal vertebrae are not a necessary component of mammalian tails. Contrary to what is frequently reported in the medical literature, there is at least one known example of a primate tail that lacks vertebrae, as found in the rudimentary two-inch-long tail of *Macaca sylvanus* (the "Barbary ape") ([Hill 1974](#), p. 616; [Hooten 1947](#), p. 23).

True human tails are rarely inherited, though several familial cases are known ([Dao and Netsky 1984](#); [Ikpeze and Onuigbo 1999](#); [Touraine 1955](#)). In one case the tail has been inherited through at least three generations of females ([Standfast 1992](#)).

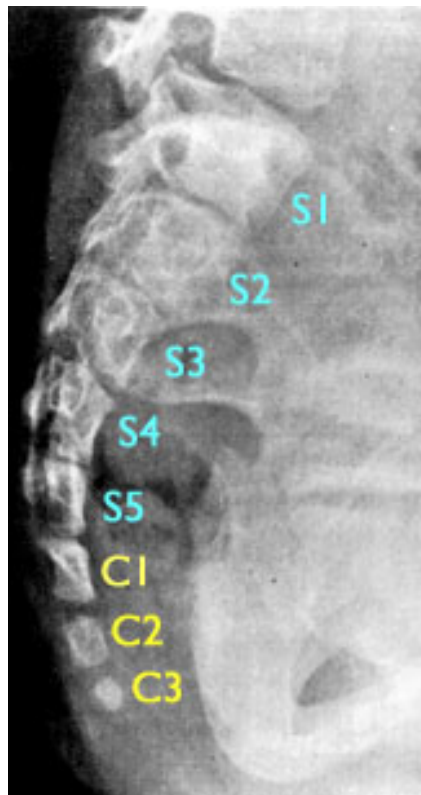

**Figure 2.2.2. X-ray image of an atavistic tail found in a six-year old girl.**

A radiogram of the sacral region of a six-year old girl with an atavistic tail. The tail was perfectly midline and protruded from the lower back as a soft appendage. The five normal sacral vertebrae are indicated in light blue and numbered; the three coccygeal tail vertebrae are indicated in light yellow. The entire coccyx (usually three or four tiny fused vertebrae) is normally the same size as the fifth sacral vertebrae. In this same study, the surgeons reported two other cases of an atavistic human tail, one with three tail vertebrae, one with five. All were benign, and only one was surgically "corrected" for cosmetic reasons (image reproduced from [Bar-Maor et al. 1980](#), Figure 3.)

As with other atavistic structures, human tails are most likely the result of either a somatic mutation, a germline mutation, or an environmental influence that reactivates an underlying developmental pathway which has been retained, if only partially, in the human genome ([Dao and Netsky 1984](#); [Hall 1984](#); [Hall 1995](#)). In fact, the genes that control the development of tails in mice and other vertebrates have been identified (the Wnt-3a and Cdx1 genes; [Greco et al. 1996](#); [Prinos et al.](#)

[2001](#); [Schubert et al. 2001](#); [Shum et al. 1999](#); [Takada et al. 1994](#)). As predicted by common descent from the atavistic evidence, these tail genes have also been discovered in the human genome ([Katoh 2002](#); [Roelink et al. 1993](#)). As discussed [below in detail](#), the development of the normal human tail in the early embryo has been investigated extensively, and apoptosis (programmed cell death) plays a significant role in removing

the tail of a human embryo after it has formed. It is now known that down-regulation of the Wnt-3a gene induces apoptosis of tail cells during mouse development ([Greco et al. 1996](#); [Shum et al. 1999](#); [Takada et al. 1994](#)), and similar effects are observed in humans ([Chan et al. 2002](#)). Additionally, researchers have identified a mutant mouse that does not develop a tail, and this phenotype is due to a regulatory mutation that decreases the Wnt-3a gene dosage ([Greco et al. 1996](#); [Gruneberg and Wickramaratne 1974](#); [Heston 1951](#)). Thus, current evidence indicates that the genetic cause of tail loss in the evolution of apes was likely a simple regulatory mutation(s) that slightly decreased Wnt-3a gene dosage. Conversely, a mutation or environmental factor that increased dosage of the Wnt-3a gene would reduce apoptosis of the human tail during development and would result in its retention, as an atavism, in a newborn.

### Criticisms:

The existence of true human tails is unfortunately quite shocking for many religiously motivated anti-evolutionists, such as Duane Gish, who has written an often-quoted article entitled "[Evolution and the human tail](#)" ([Gish 1983](#); see also [Menton 1994](#); [ReMine 1982](#)). Solely based on the particulars of a single case study ([Ledley 1982](#)), these authors have erroneously concluded that atavistic human tails are "nothing more than anomalous malformations not traceable to any imaginary ancestral state" ([Gish 1983](#)). However, their arguments are clearly directed against pseudo-tails, not true tails. Gish claims these structures are not true tails for several reasons: (1) they lack vertebrae, (2) they are not inherited, and (3) the resemblance to tails is "highly superficial" and simply an "anomalous malformation". Menton further claims that (4) all true tails have muscles and can move, whereas human tails cannot. Each of these arguments are factually false, as explained above and as well-documented in the medical literature. Vertebrae and cartilage have occasionally been found in human tails. However, contrary to the claims of Gish, Menton, and ReMine, vertebrae are not a requirement for tails. *M. sylvanus* is a prime example of a primate whose fleshy tail lacks vertebrae ([Hill 1974](#), p. 616; [Hooten 1947](#), p. 23). Several cases are known where human tails have been inherited. Furthermore, we now know the genes responsible for the development of tails in mammals, and all humans have them. Inheritance of the tail structure *per se* is unnecessary since the developmental system has been inherited but is normally inactivated in humans. The "resemblance" to non-human tails is far from superficial, since all true human tails are complex structures composed of symmetrical layers of voluntary muscle, blood vessels, specialized nerves and sensing organs, and they can indeed move and contract.

For the skeptical reader, probably the best evidence that these structures are true tails is visual inspection. [Photographic images](#) of a newborn's atavistic tail can be found at the University of Iowa's [Virtual Hospital](#) site, complete with the voluntary contractory movement of the tail documented.

## Potential Falsification:

These are essentially the same as for vestigial structures above.

## Prediction 2.3: Molecular vestigial characters

Vestigial characters should also be found at the molecular level. Humans do not have the capability to synthesize ascorbic acid (otherwise known as Vitamin C), and the unfortunate consequence can be the nutritional deficiency called scurvy. However, the predicted ancestors of humans had this function (as do most other animals except primates and guinea pigs). Therefore, we predict that humans, other primates, and guinea pigs should carry evidence of this lost function as a molecular vestigial character (*nota bene*: this very prediction was explicitly made by Nishikimi and others and was the impetus for the research detailed below) ([Nishikimi et al. 1992](#); [Nishikimi et al. 1994](#)).

## Confirmation:

Recently, the L-gulano- $\gamma$ -lactone oxidase gene, the gene required for Vitamin C synthesis, was found in humans and guinea pigs ([Nishikimi et al. 1992](#); [Nishikimi et al. 1994](#)). It exists as a pseudogene, present but incapable of functioning (see [prediction 4.4](#) for more about pseudogenes). In fact, since this was originally written the vitamin C pseudogene has been found in other primates, exactly as predicted by evolutionary theory. We now have the DNA sequences for this broken gene in chimpanzees, orangutans, and macaques ([Ohta and Nishikimi 1999](#)). And, as predicted, the malfunctioning human and chimpanzee pseudogenes are the most similar, followed by the human and orangutan genes, followed by the human and macaque genes, precisely as predicted by evolutionary theory. Furthermore, all of these genes have accumulated mutations at the exact rate predicted (the background rate of mutation for neutral DNA regions like pseudogenes) ([Ohta and Nishikimi 1999](#)).

There are several other examples of vestigial human genes, including multiple odorant receptor genes ([Rouquier et al. 2000](#)), the RT6 protein gene ([Haag et al. 1994](#)), the galactosyl transferase gene ([Galili and Swanson 1991](#)), and the tyrosinase-related gene (TYRL) ([Oetting et al. 1993](#)).

Our odorant receptor (OR) genes once coded for proteins involved in now lost olfactory functions. Our predicted ancestors, like other mammals, had a more acute sense of smell than we do now; humans have &#99 odorant receptor genes, of which ~70% are pseudogenes. Many other mammals, such as mice and marmosets, have many of the same OR genes as us, but all of theirs actually work. An extreme case is the dolphin, which is the descendant of land mammals. It no longer has any need to smell volatile odorants, yet it

contains many OR genes, of which none are functional — they are all pseudogenes ([Freitag et al. 1998](#)).

The RT6 protein is expressed on the surface of T lymphocytes in other mammals, but not on ours. The galactosyl transferase gene is involved in making a certain carbohydrate found on the cell membranes of other mammals. Tyrosinase is the major enzyme responsible for melanin pigment in all animals. TYRL is a pseudogene of tyrosinase.

It is satisfying to note that we share these vestigial genes with other primates, and that the mutations that destroyed the ability of these genes perform their metabolic functions are also shared with several other primates (see [predictions 4.3-4.5](#) for more about shared pseudogenes).

### Potential Falsification:

It would be very puzzling if we had not found the L-gulano- $\gamma$ -lactone oxidase pseudogene or the other vestigial genes mentioned. In addition, we can predict that we will never find vestigial chloroplast genes in any metazoans (i.e. animals) ([Li 1997](#), pp. 284-286, 348-354).

## Prediction 2.4: Ontogeny and Development of Organisms

- [Example 1: mammalian ear bones and reptile jaws](#)
- [Example 2: pharyngeal pouches and branchial arches](#)
- [Example 3: snake and whale embryos with legs](#)
- [Example 4: embryonic human tail](#)
- [Example 5: marsupial eggshell and caruncle](#)



**Figure 2.4.1. Cat and human embryos in the tailbud stage.** A cat embryo is shown on top, a human embryo below. Note the post-anal tail in both,

Embryology and developmental biology have provided some fascinating insights into evolutionary pathways. Because morphological cladistic classifications of species are generally based on derived characters of adult organisms, embryology and developmental studies provide a nearly independent body of evolutionary evidence. The final adult structure of an organism is the product of numerous cumulative developmental processes. For a species to evolve morphologically,



positioned at the lower left below the head of each. The human embryo is about 32 days old.

these developmental processes necessarily must have changed. The macroevolutionary conclusion is that the development of an organism is a modification of its ancestors' ontogenies ([Futuyma 1998](#), pp. 652-653). Early in the 20th century, developmental biologist Walter Garstang first stated correctly that

ontogeny creates phylogeny. What this means is that once given knowledge about an organism's ontogeny, we can confidently predict certain aspects of the historical pathway that was involved in this organism's evolution ([Gilbert 1997](#), pp. 912-914). Thus, embryology provides testable confirmations and predictions about macroevolution.

## Confirmation:

### Example 1: mammalian ear bones and the reptilian jaw

From embryological studies it is known that two bones of a developing reptile eventually form the quadrate and the articular bones in the hinge of the adult reptilian jaw (first reported in 1837 by the German embryologist Karl Reichert). However, in the marsupial mammalian embryo, the same two structures develop, not into parts of the jaw, but into the anvil and hammer of the mammalian ear. This developmental information, coupled with common descent, indicates that the mammalian middle ear bones were derived and modified from the reptilian jaw bones during evolution ([Gilbert 1997](#), pp. 894-896).

Accordingly, there is a very complete series of fossil intermediates in which these structures are clearly modified from the reptilian jaw to the mammalian ear (compare the intermediates discussed in [prediction 1.4, example 2](#)) ([Carroll 1988](#), pp. 392-396; [Futuyma 1998](#), pp. 146-151; [Gould 1990](#); [Kardong 2002](#), pp. 255-275).

### Example 2: vertebrate pharyngeal pouches and branchial arches

There are numerous other examples in which an organism's evolutionary history is represented temporarily in its development. Early in development, mammalian embryos temporarily have pharyngeal pouches, which are morphologically indistinguishable from aquatic vertebrate gill pouches ([Gilbert 1997](#), pp. 380, 382). This evolutionary relic reflects the fact that mammalian ancestors were once aquatic gill-breathing vertebrates. The pharyngeal pouches of modern fish embryos eventually become perforated to form gills. Mammalian pharyngeal pouches of course do not develop into gills, but rather give rise to structures that evolved from gills, such as the eustachian tube, middle ear, tonsils, parathyroid, and thymus ([Kardong 2002](#), pp. 52, 504, 581). The arches between the gills,

called branchial arches, were present in jawless fish and some of these branchial arches later evolved into the bones of the jaw, and, eventually, into the bones of the inner ear as recounted above and in [prediction 1.4, example 2](#).

### Example 3: hindlimbs in snake and whale embryos

Many species of snakes and legless lizards (such as the "slow worm") initially develop limb buds in their embryonic development, only to reabsorb them before hatching ([Raynaud 1990](#); [Raynaud and Kan 1992](#); [Raynaud and Van den Elzen 1976](#)). Similarly, modern adult whales, dolphins, and porpoises have no hind legs. Even so, hind

legs, complete with various developing leg bones, nerves, and blood vessels, temporarily appear in the cetacean fetus and subsequently degenerate before birth ([Amasaki et al. 1989](#); [Sedmera et al. 1997](#)). These rudimentary hindlimb buds persist longer in the embryos of baleen humpback whales (*Megaptera nodosa*) than in other cetaceans, a fact which may explain why atavistic external hindlimbs are found more often in baleen whales than in other cetaceans ([Bejder and Hall 2002](#); for photographs of the large atavistic femur, tibia, and tarsus found in a female humpback whale see [Figure 2.2.1](#) above).

### Example 4: the embryonic human tail

Humans are classified by taxonomists as apes; one of the defining derived characters of apes is the lack of an external tail. However, human embryos initially develop tails in development. At between four and five weeks of age, the normal human embryo has 10-12 developing tail vertebrae which extend beyond the anus and legs, accounting for more than 10% of the length of the embryo ([Fallon and Simandl 1978](#); [Moore and Persaud 1998](#), pp. 91-100; [Nievelstein et al. 1993](#)). The embryonic tail is composed of several complex tissues besides the developing vertebrae, including a secondary neural tube (spinal cord), a notochord, mesenchyme, and tail gut. By the eighth week of gestation, the sixth to twelfth vertebrae have disappeared via cell death, and the fifth and fourth tail vertebrae are still being reduced. Likewise, the associated tail tissues also undergo cell death and regress.

**Figure 2.4.2. Dolphin embryo with well-developed early hindlimb bud.**

Embryo of the spotted dolphin (*Stenella attenuata*) at 24 days gestation. **f** = well-developed forlimb bud, **h** = well-developed early hindlimb bud. Also compare with the cat and human embryos of similar age in [Figure 2.4.1](#) above.

(Reproduced from [Sedmera et al. 1997](#))

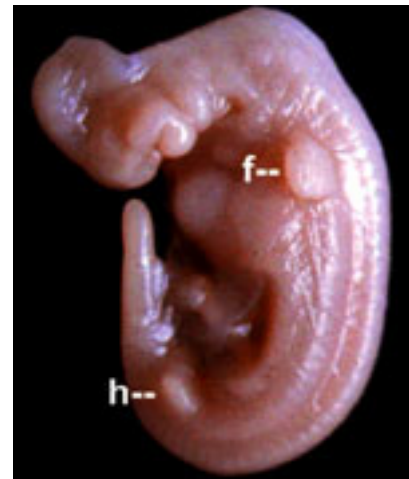

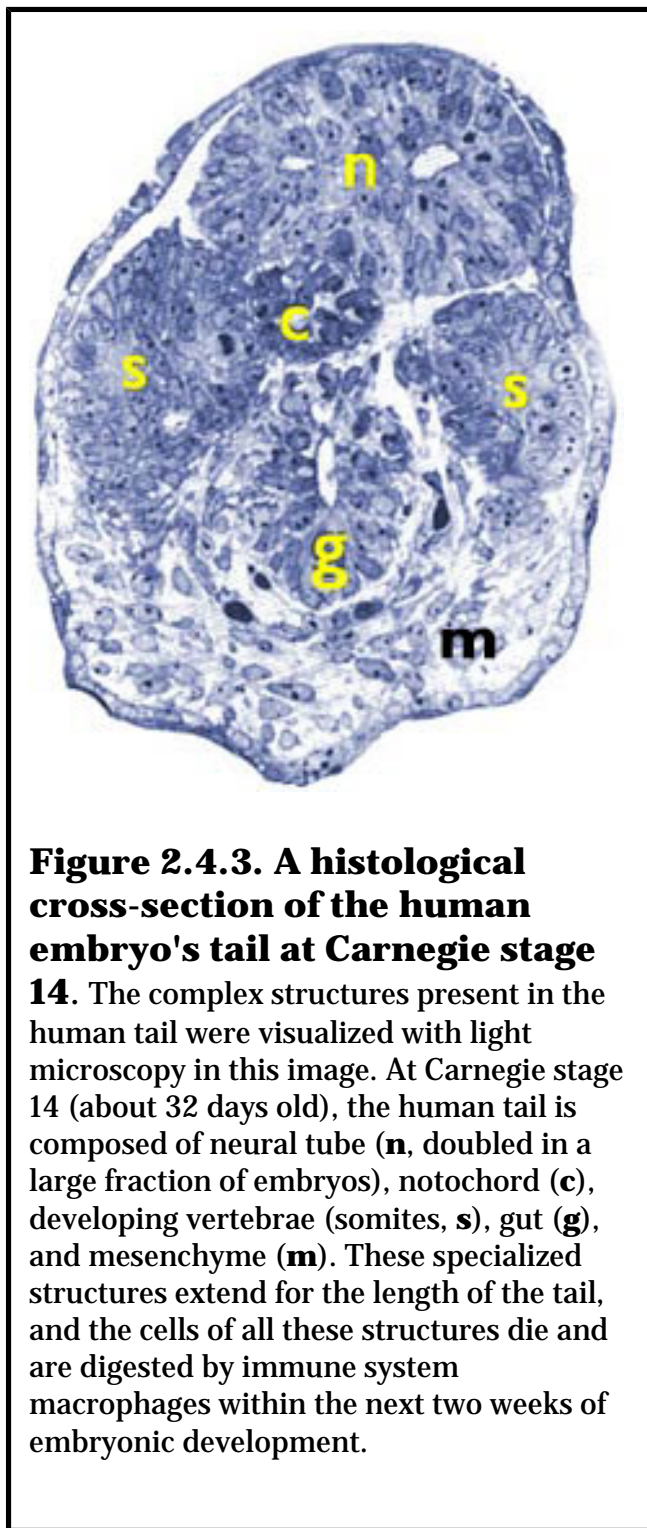

**Figure 2.4.3. A histological cross-section of the human embryo's tail at Carnegie stage 14.** The complex structures present in the human tail were visualized with light microscopy in this image. At Carnegie stage 14 (about 32 days old), the human tail is composed of neural tube (**n**, doubled in a large fraction of embryos), notochord (**c**), developing vertebrae (somites, **s**), gut (**g**), and mesenchyme (**m**). These specialized structures extend for the length of the tail, and the cells of all these structures die and are digested by immune system macrophages within the next two weeks of embryonic development.

Using light and scanning electron microscopy, several detailed analyses of the embryonic human tail have shown that the dead and degenerating tail cells are ingested and digested by macrophages (macrophages are large white blood cells of the immune system which more normally ingest and destroy invading pathogens such as bacteria) ([Fallon and Simandl 1978](#); [Nivelstein et al. 1993](#); [Sapunar et al. 2001](#); [Saraga-Babic et al. 1994](#); [Saraga-Babic et al. 2002](#)). In adult humans, the tail is finally reduced to a small bone composed of just four fused vertebrae (the coccyx) which do not protrude from the back ([Fallon and Simandl 1978](#); [Sapunar et al. 2001](#)) (see Figure 2.4.1).

The regression of the human embryonic tail can be clearly seen in the fantastic images available at the [Multi-dimensional Human Embryo](#) site, where online images of three-dimensional MRI scans of live human embryos are archived. Different levels of maturity of the human embryo are classified according to the [Carnegie stages](#). The embryonic post-anal tail is clearly visible in Carnegie stages [14](#), [15](#), and [16](#). The site has movies of a human embryo in rotation, giving clear views of the embryo's three-dimensional contours. Most stages have movies with the neural tube highlighted. It is especially informative to compare these rotating movies of the early stages (e.g. Carnegie [stage 14](#) or [stage 15](#)) with the last stage ([Carnegie stage 23](#)), where the regression by cell death of the neural tube in the tail is clearly evident.

## Example 5: marsupial eggshells and caruncles

Reptiles and birds lay eggs, and the emerging young use either an "egg-tooth" to cut through a leathery keratinous eggshell (as found in lizards and snakes) or a specialized structure, called a caruncle, to crack their way out of a hard calcereous eggshell (as found in turtles and birds). Mammals evolved from a reptile-like ancestor, and placental mammals (like humans and dogs) have lost the egg-tooth and caruncle (and, yes, the



eggshell). However, monotremes, such as the platypus and echidna, are primitive mammals that have *both* an egg-tooth and a caruncle, even though the monotreme eggshell is thin and leathery ([Tyndale-Biscoe and Renfree 1987](#), p. 409). Most strikingly, during marsupial development, an eggshell forms transiently and then is reabsorbed before live birth. Though they have no need to hack through a hard egg-shell, several marsupial newborns (such as baby Brushtail possums, koalas, and bandicoots) retain a vestigial caruncle as a clear indicator of their reptilian, oviparous ancestry ([Tyndale-Biscoe and Renfree 1987](#), p. 409).

### Potential Falsification:

Based on our standard phylogenetic tree, we may expect to find gill pouches or egg shells at some point in mammalian embryonic development (and we do). However, we never expect to find nipples, hair, or a middle-ear incus bone at any point in fish, amphibian, or reptilian embryos. Likewise, we might expect to find teeth in the mouths of some avian embryos (as we do), but we never expect to find bird-like beaks in eutherian mammal embryos (eutherians are placental mammals such as humans, cows, dogs, or rabbits). We may expect to find human embryos with tails (and we do; see Figure 2.3.1), but we never expect to find leg buds or developing limbs in the embryos of manta rays, eels, teleost fish, or sharks. Any such findings would be in direct contradiction to macroevolutionary theory ([Gilbert 1997](#), esp. Ch. 23).

### Criticisms:

Some evolutionary critics wrongly think that because Ernst Haeckel's "Biogenetic Law" is false, embryology can no longer provide evidence for evolution. However, this is a curious assessment, since neither modern evolutionary theory nor modern developmental biology are based upon Haeckel's observations and theories. The discussion above is in no way an endorsement of either "Von Baer's Laws" or Haeckel's Biogenetic Law. Both of these fail as scientific laws, and both are incorrect as generalizations. Evolutionary change can proceed via these patterns, but it often does not.

The ideas of Ernst Haeckel greatly influenced the early history of embryology in the 19th century. Haeckel hypothesized that "Ontogeny Recapitulates Phylogeny", meaning that during its development an organism passes through stages resembling its adult ancestors. However, Haeckel's ideas long have been superseded by those of Karl Ernst von Baer, his predecessor. Von Baer suggested that the embryonic stages of an individual should resemble the *embryonic* stages of other closely related organisms, rather than resembling its *adult* ancestors. Haeckel's Biogenetic Law has been discredited since the late 1800's, and it is not a part of modern (or even not-so-modern) evolutionary theory. Haeckel thought only the final stages of development could be altered appreciably by evolution, but we have known that to be false for nearly a century. All developmental stages can be modified during evolution, though the phylotypic stage may be more constrained than

others. For more about Haeckel's Biogenetic Law, developmental phylotypes, and the evidence embryology provides in modern evolutionary theory, see "[Wells and Haeckel's Embryos](#)" by PZ Meyers, or refer to a modern developmental biology college-level textbook such as [Gilbert 1997](#), pp. 912-914.

## Prediction 2.5: Present biogeography

Because species divergence happens not only in the time dimension, but also in spatial dimensions, common ancestors originate in a particular geographical location. Thus, the spatial and geographical distribution of species should be consistent with their predicted genealogical relationships. The standard phylogenetic tree predicts that new species must originate close to the older species from which they are derived. Closely related contemporary species should be close geographically, regardless of their habitat or specific adaptations. If they are not, there had better be a good explanation, such as extreme mobility (cases like sea animals, birds, human mediated distribution, etc.), continental drift, or extensive time since their divergence. In this sense, the present biogeographical distribution of species should reflect the history of their origination.

A reasonable nonevolutionary prediction is that species should occur wherever their habitat is. However, macroevolution predicts just the opposite — there should be many locations where a given species would thrive yet is not found there, due to geographical barriers ([Futuyma 1998](#), pp. 201-203).

### Confirmation:

With few exceptions, marsupials only inhabit Australia. The exceptions (some South American species and the opossum) are explained by continental drift (South America, Australia, and Antarctica were once the continent of Gondwanaland). Conversely, placental mammals are virtually absent on Australia, despite the fact that many would flourish there. Humans introduced most of the few placentals found on Australia, and they have spread rapidly.

Similarly, the southern reaches of South America and Africa and all of Australia share lungfishes, ostrich-like birds (ratite birds), and leptodactylid frogs — all of which occur nowhere else. Alligators, some related species of giant salamander, and magnolias only occur in Eastern North America and East Asia (these two locations were once spatially close in the Laurasian continent).

In addition, American, Saharan and Australian deserts have very similar habitats, and plants from one grow well in the other. However, indigenous Cacti only inhabit the Americas, while Saharan and Australian vegetation is very distantly related (mostly Euphorbiaceae). Humans introduced the only Cacti found in the Australian outback, and

they grow quite well in their new geographical location.

The west and east coast of South America is very similar in habitat, but the marine fauna is very different. In addition, members of the closely related pineapple family inhabit many diverse habitats (such as rainforest, alpine, and desert areas), but only in the American tropics, not African or Asian tropics ([Futuyma 1998](#), ch. 8).

### Potential Falsification:

From a limited knowledge of species distributions, we predict that we should never find elephants on distant Pacific islands, even though they would survive well there. Similarly, we predict that we should not find amphibians on remote islands, or indigenous Cacti on Australia. Closely related species could be distributed evenly worldwide, according to whichever habitat best suits them. If this were the general biogeographical pattern, it would be a strong blow to macroevolution ([Brown and Lomolino 1998](#)).

## Prediction 2.6: Past biogeography

- [Example 1: marsupials](#)
- [Example 2: horses](#)
- [Example 3: apes and humans](#)

Past biogeography, as recorded by the fossils that are found, must also conform to the standard phylogenetic tree.

### Example 1: marsupials

As one example, we conclude that fossils of the hypothetical common ancestors of South American marsupials and Australian marsupials should be found dating from before these two landmasses separated.

### Confirmation:

Consequently, we find the earliest marsupial fossils (e.g., *Alphadon*) from the Late Cretaceous, when South America, Antarctica, and Australia were still connected. Additionally, the earliest ancestors of modern marsupials are actually found on North America. The obvious paleontological deduction is that extinct marsupial fossil organisms should be found on South America and Antarctica, since marsupials must have traversed these continents to reach their present day location in Australia. Interestingly, we have found marsupial fossils on both South America and on Antarctica. This is an astounding macroevolutionary confirmation, given that no marsupials live on Antarctica

now ([Woodburne and Case 1996](#)).

### Potential Falsification:

We confidently predict that fossils of recently evolved animals like apes and elephants should never be found on South America, Antarctica, or Australia (excepting, of course, the apes that travel by boat).

### Example 2: horses

As a second example, very complete fossil records should be smoothly connected geographically. Intermediates should be found close to their fossil ancestors.

### Confirmation:

The Equidae (i.e. horse) fossil record is very complete (though extremely complex) and makes very good geographical sense, without any large spatial jumps between intermediates. For instance, at least ten intermediate fossil horse genera span the past 58 million years. Each fossil genus spans approximately 5 million years, and each of these genera includes several intermediate paleospecies (usually 5 or 6 in each genus) that link the preceding and following fossil intermediates. They range from the earliest genus, *Hyracotherium*, which somewhat resembled a dog, through *Orohippus*, *Epihippus*, *Meshippus*, *Miohippus*, *Parahippus*, *Merychippus*, *Dinohippus*, *Equus*, to Modern *Equus*. Every single one of the fossil ancestors of the modern horse are found on the North American continent ([MacFadden 1992](#), pp. 99, 156-162). For more detail about the known evolution of the Equidae, consult Kathleen Hunt's thorough FAQ on [Horse Evolution](#).

### Potential Falsification:

It would be macroevolutionarily devastating if we found in South America an irrefutable *Epihippus* or *Merychippus* (or any of the intermediates in-between) from the Paleocene, Eocene, Oligocene, the Miocene, or anytime before the Isthmus of Panama arose to connect North and South America (about 12 million years ago). Moreover, we should never find fossil horse ancestors on Australia or Antarctica from any geological era ([MacFadden 1992](#); [Brown and Lomolino 1998](#)).

### Example 3: apes and humans

As our third example, consider the African apes. Humans are most closely related to the great apes that are indigenous to Africa (as determined by cladistic morphological

analysis and confirmed by DNA sequence analysis). Why did the [Leakeys](#), [Raymond Dart](#), and [Robert Broom](#) go to Africa in search of early hominid fossils? Why not dig in Australia, North America, South America, Siberia, or Mesopotamia? Charles Darwin gave an answer for this question over 130 years ago - long before any early hominid fossils had been found.

"We are naturally led to enquire, where was the birthplace of man at that stage of descent when our progenitors diverged from the Catarrhine stock? The fact that they belonged to this stock clearly shews that they inhabited the Old World; but not Australia nor any oceanic island, as we may infer from the laws of geographical distribution. In each great region of the world the living mammals are closely related to the extinct species of the same region. It is therefore probable that Africa was formerly inhabited by extinct apes closely allied to the gorilla and chimpanzee; and as these two species are now man's nearest allies, it is somewhat more probable that our early progenitors lived on the African continent than elsewhere." ([Darwin 1871](#), p. 161)

Thus, the theory of common descent predicts that we may find early hominid fossils on the African continent.

### Confirmation:

Numerous transitional fossils between humans and the great apes have been found in southern and eastern Africa. For examples, discussion, pictures, detail, and extensive references refer to Jim Foley's comprehensive [Fossil Hominid's FAQ](#). These examples include such fossil species as *Ardipithecus ramidus*, *Australopithecus anamensis*, *Australopithecus afarensis*, *Australopithecus garhi*, *Kenyanthropus platyops*, *Kenyanthropus rudolfensis*, *Homo habilis*, and a host of other transitionals thought to be less related to *Homo sapiens*, such as the robust australopithicenes. At this point in time, the difficulty in reconstructing exact genealogical relationships among all of these fossils species is that there are too many links, not that there are missing links. Like most family trees, the family tree of the hominids is best described as a wildly branching bush.

### Potential Falsification:

We do not expect to ever find any *Australopithecus*, *Ardipithecus*, or *Kenyanthropus* fossils in Australia, North America, South America, Antarctica, Siberia, or on any oceanic islands removed from Africa. Any such findings would be catastrophically problematic for the theory of common descent.



[Previous](#)

[Contents](#)

[Next](#)

## References

- Abel, O. (1908) "Die Morphologie der Huftbeinrudimente der Cetaceen." Denkschr. Math. Naturw. Klasse Kaiserl. Aka. Wiss. Vol. 81.
- Amasaki, H., Ishikawa, H., and Daigo, M. (1989) "Developmental changes of the fore- and hind-limbs in the fetuses of the southern minke whale, *Balaenoptera acutorostrata*." Anat Anz 169: 145-148. [\[PubMed\]](#)
- Andrews, R. C. (1921) "A remarkable case of external hind limbs in a humpback whale." Amer. Mus. Novitates. No. 9. June 3, 1921.
- Bar-Maor, J. A., Kesner, K. M., and Kaftori, J. K. (1980) "Human tails." J Bone Joint Surg Br. 62-B: 508-510. [\[PubMed\]](#)
- Baruchin, A. M., Mahler, D., Hauben, D. J., and Rosenberg, L. (1983) "The human caudal appendage (human tail)." Br J Plast Surg. 36: 120-123. [\[PubMed\]](#)
- Batten, D., and Sarfati, J. (2003) "'Vestigial' Organs: What do they prove?" <http://www.answersingenesis.org/docs/446.asp>
- Bejder, L. and Hall, B.K. (2002) "Limbs in whales and limblessness in other vertebrates: mechanisms of evolutionary and developmental transformation and loss." Evol Dev 4: 445-458. [\[PubMed\]](#)
- Belzberg, A. J., Myles, S. T., and Trevenen, C. L. (1991) "The human tail and spinal dysraphism." J Pediatr Surg 26: 1243-1245. [\[PubMed\]](#)
- Bergman, J. and Howe, G. (1990) "**Vestigial Organs" Are Fully Functional.** Kansas City, MO. Creation Research Society Books.
- Berzin, A. A. (1972) **The Sperm Whale.** Pacific Scientific Research Institute of Fisheries and Oceanography. Israel Program for Scientific Translations, Jerusalem. Available from the U. S. Dept. of Commerce, National Technical Information Service. Springfield, VA.
- Besharse, J. C., and Brandon, R. A. (1976) "Effects of continuous light and darkness on the eyes of the troglobitic salamander *Typhlotriton spelaeus*." J Morphol 149: 527-546. [\[PubMed\]](#)
- Brown, J. H., and Lomolino, M. V. (1998) **Biogeography.** Second edition. Boston, MA: Sunderland.
- Carroll, R. L. (1988) **Vertebrate Paleontology and Evolution.** New York, W. H. Freeman and Co.

Carroll, R. L. (1997) **Patterns and Processes of Vertebrate Evolution**. Cambridge: Cambridge University Press.

Chan, B. W., Chan, K. S., Koide, T., Yeung, S. M., Leung, M. B., Copp, A. J., Loeken, M. R., Shiroishi, T., and Shum, A. S. (1994) "Maternal diabetes increases the risk of caudal regression caused by retinoic acid." *Diabetes* 51: 2811-2816. [[PubMed](#)]

Cohn, M. J. (2001) "Developmental mechanisms of vertebrate limb evolution." *Novartis Found Symp.* 232: 47-57. [[PubMed](#)]

Cohn, M. J., and Tickle, C. (1999) "Developmental basis of limblessness and axial patterning in snakes." *Nature* 399: 474-479. [[PubMed](#)]

Crapo, R. (1985) "Are the vanishing teeth of fetal baleen whales useless?" *Origins Research* 7: 1.

Culver, D.C., Fong, D.W., and Kane T.C. (1995) "Vestigialization and Loss of Nonfunctional Characters." *Annual Review of Ecology and Systematics* 26: 249-268.

Dao, A. H., and Netsky, M. G. (1984) "Human tails and pseudotails." *Human Pathology* 15: 449-453. [[PubMed](#)]

Darwin, C. (1859) **The Origin of Species**. First Edition. [[HTML formatted text at Talk.Origins Archive](#)]

Darwin, C. (1871) **The Descent of Man**. Amherst, New York, Prometheus Books.

Darwin, C. (1872) **The Origin of Species**. Sixth Edition. The Modern Library, New York. [[Project Gutenberg text file](#)]

**Dictionary of Bioscience**. (1997) Sybil P. Parker, editor in chief. New York: McGraw-Hill.

Dodson, E. O. (1960) **Evolution: Process and Product**. New York: Reinhold Publishers.

Dubrow, T. J., Wackym, P. A., and Lesavoy, M. A. (1988) "Detailing the human tail." *Annals of Plastic Surgery* 20:340-344. [[PubMed](#)]

Durand, J., Keller, N., Renard, G., Thorn, R., and Pouliquen, Y. (1993) "Residual cornea and the degenerate eye of the cryptophthalmic *Typhlotriton spelaeus*." *Cornea* 12: 437-447. [[PubMed](#)]

Fallon, J. F., and Simandl, B. K. (1978) "Evidence of a role for cell death in the disappearance of the embryonic human tail." *Am J Anat* 152: 111-129. [[PubMed](#)]

Fara, M. (1977) "Coccygeal ('tail') projection with cartilage content." *Acta Chir. Plast.* 19: 50-55. [[PubMed](#)]

Freitag, J., G. Ludwig, *et al.* (1998) "Olfactory receptors in aquatic and terrestrial vertebrates." *Journal of Comparative Physiology* 183: 635-650. [[PubMed](#)]

- Futuyma, D. (1998) **Evolutionary Biology**. Third edition. Sunderland, Mass., Sinauer Associates.
- Galili, U., and Swanson, K. (1991) "Gene sequences suggest inactivation of alpha-1,3-galactosyltransferase in catarrhines after the divergence of apes from monkeys." PNAS 88: 7401-7404. <http://www.pnas.org/cgi/content/abstract/88/16/7401>
- Geoffroy St. Hilaire (1798) "Observations sur l'aile de l'Autruche, par le citoyen Geoffroy." in **La Decade Egyptienne, Journal Litteraire et D'Economie Politique**. Premier Volume. Au Kaire, de L'Imprimerie Nationale. pp. 46-51
- Gilbert, S. F. (1997) **Developmental Biology**. Fifth edition. Sinauer Associates.
- Gish, D. T. (1983) "Evolution and the human tail." ICR Impact No. 117 <http://www.icr.org/pubs/imp/imp-117.htm>
- Gould, S. J. (1990) "An earful of jaw." Natural History 3: 12-23.
- Grange, G., Tantau, J., Pannier, E., Aubry, M. C., Viot, G., Fallet-Bianco, C., Terrasse, G., and Cabrol, D. (2001) "Prenatal diagnosis of fetal tail and postabortum anatomical description." Ultrasound Obstet Gynecol 18: 531-533. [\[PubMed\]](#)
- Greco, T. L., Takada, S., Newhouse, M. M., McMahon, J. A., McMahon, A. P., Camper, S. A. (1996) "Analysis of the vestigial tail mutation demonstrates that Wnt-3a gene dosage regulates mouse axial development." Genes Dev 10: 313-324. [\[PubMed\]](#)
- Griffiths, P. (1992) "Adaptive explanation and the concept of a vestige." in **Trees of Life: essays in philosophy of biology**. Edited by Paul Griffiths. Dordrecht, Boston: Kluwer Academic Publishers.
- Grosso, N. P., and van Dam, B. E. (1995) "Total coccygectomy for the relief of coccygodynia: a retrospective review." J Spinal Disord 8: 328-330. [\[PubMed\]](#)
- Gruneberg, H. and Wickramaratne, G. A. (1974) "A re-examination of two skeletal mutants of the mouse, vestigial-tail (vt) and congenital hydrocephalus (ch)." J Embryol Exp Morphol. 31: 207-22. [\[PubMed\]](#)
- Haag, F., Koch-Nolte, F. *et al.* (1994) "Premature stop codons inactivate the RT6 genes of the human and chimpanzee species." Journal of Molecular Biology 243: 537-546. [\[PubMed\]](#)
- Hall, B. K. (1984) "Developmental mechanisms underlying the formation of atavisms." Biol. Rev. 59: 89-124.
- Hall, B. K. (1995) "Atavisms and atavistic mutations." Nature Genetics 10: 126-127. [\[PubMed\]](#)
- Hall, B. K. (2003) "Descent with modification: the unity underlying homology and homoplasy as seen through an analysis of development and evolution." Biol Rev Camb Philos Soc 78: 409-433. [\[PubMed\]](#)
- Ham, K., Sarfati, J. and Wieland, C. (1990) **The Answers Book - Revised & Expanded**, Batten, D. ed., Master Books.



Ham, K., and Wieland, C. (1997) "Your appendix: It's there for a reason." *Creation Ex Nihilo* 20: 41-43. <http://www.answersingenesis.org/docs/357.asp>

Harrison, R. G. (1901) "Occurrence of tails in man, with a description of a case reported by Dr. Watson." *Johns Hopkins Hosp. Bull.* 12:96-101.

Hattab, F. N., Rawashdeh, M. A., and Fahmy, M. S. (1995) "Impaction status of third molars in Jordanian students." *Oral Surg Oral Med Oral Pathol Oral Radiol Endod.* 79: 24-29. [\[PubMed\]](#)

Heston, W. E. (1951) "The 'vestigial tail' mouse: A new recessive mutation." *J Hered.* 42: 71-74.

Hill, W. C. O. (1974) **Primates: Comparative Anatomy and Taxonomy. VII. Cyproithecinae: Cercocebus, Maccaca, Cynopithecus.** New York: Halstead Press, John Wiley and Sons.

Hooten, E. A. (1947) **Up From the Ape.** Second edition. New York: Macmillan.

Ikpeze, O. C., and Onuigbo, W. I. (1999) "A bisegmented human tail in an African baby." *Br J Plast Surg.* 52: 329-330. [\[PubMed\]](#)

Jeffery, W. R. (2001) "Cavefish as a model system in evolutionary developmental biology." *Dev Biol.* 231: 1-12. [\[PubMed\]](#)

Kardong, K. V. (2002) **Vertebrates: Comparative Anatomy, Function, Evolution.** Third ed. New York: McGraw Hill.

Katoh, M. (2002) "Molecular cloning and expression of mouse Wnt14, and structural comparison between mouse Wnt14-Wnt3a gene cluster and human WNT14-WNT3A gene cluster." *Int J Mol Med* 9 :221-227. [\[PubMed\]](#)

Keith, A. (1921) "Human tails." *Nature* 106 :845-846.

Kollar, E. J., and Fisher, C. (1980) "Tooth induction in chick epithelium: expression of quiescent genes for enamel synthesis." *Science* 207 :993-995. [\[PubMed\]](#)

Kos, M., Bulog, B., Szel, A., and Rohlich, P. (2001) "Immunocytochemical demonstration of visual pigments in the degenerate retinal and pineal photoreceptors of the blind cave salamander *Proteus anguinus*." *Cell Tissue Res* 303: 15-25. [\[PubMed\]](#)

Lamarck, J. B. (1809) **Zoological Philosophy: An Exposition with Regard to the Natural History of Animals.** Translated by Hugh Elliot. Chicago and London: University of Chicago Press. 1984.

Ledley, F. D. (1982) "Evolution and the human tail." *New Eng. J. Med.* 306: 1212-1215. [\[PubMed\]](#)

Li, W.-H. (1997) **Molecular Evolution.** Sunderland, MA, Sinauer Associates.

- Litonjua, L. S. (1996) "Pericoronitis, deep fascial space infections, and the impacted third molar." J Philipp Dent Assoc. 47: 43-47. [\[PubMed\]](#)
- Lundberg, G. D., and Parsons, R. W. (1962) "A case of human tail." Am. J. Dis. Child 104: 72.
- McCabe, J. (1912) **The Story of Evolution**. Boston: Small, Maynard, and Co.
- MacFadden, B. J. (1992) **Fossil Horses: Systematics, Paleobiology, and Evolution of the Family Equidae**. New York, Cambridge University Press.
- Menton, D. N. (1994) "The Human Tail, and Other Tales of Evolution." St. Louis MetroVoice. Vol. 4, No. 1. <http://www.gennet.org/facts/metro07.html>
- Merrell, D. J. (1962) **Evolution and Genetics: The Modern Theory of Evolution**. New York: Holt, Rinehart and Winston.
- Mes, T. H., Kuperus, P., Kirschner, J., Stepanek, J., Storchova, H., Oosterveld, P., and den Nijs, J. C. (2002) "Detection of genetically divergent clone mates in apomictic dandelions." Mol Ecol. 2002 11: 253-265. [\[PubMed\]](#)
- Moody, P. A. (1962) **Introduction to Evolution**. Second edition. New York: Harper.
- Moore, K. L. and Persaud, T. V. N. (1998) **The developing human: clinically oriented embryology**. 6th ed., editor Schmitt, W., Saunders, Philadelphia.
- Morris, H. (1986) "The Vanishing Case for Evolution - IMPACT No. 156 June 1986." <http://www.icr.org/pubs/imp/imp-156.htm>
- Muller, G. B. (2002) "Vestigial Organs and Structures." in **Encyclopedia of Evolution** . Mark Pagel, editor in chief, New York: Oxford University Press.
- Naylor, B. G. (1982) "Vestigial organs are evidence of evolution." Evolutionary Theory 6: 91-96.
- Nemoto, T. (1963) "New records of sperm whales with protruded rudimentary hind limbs." Sci. Rep. Whales Res. Inst. No. 17.
- Nievelstein, R. A., Hartwig, N. G., Vermeij-Keers, C., and Valk, J. (1993) "Embryonic development of the mammalian caudal neural tube." Teratology 48: 21-31. [\[PubMed\]](#)
- Nishikimi, M., R. Fukuyama, *et al.* (1994) "Cloning and chromosomal mapping of the human nonfunctional gene for L-gulonogamma-lactone oxidase, the enzyme for L-ascorbic acid biosynthesis missing in man." Journal of Biological Chemistry 269: 13685-13688. [\[PubMed\]](#)
- Nishikimi, M., T. Kawai, *et al.* (1992) "Guinea pigs possess a highly mutated gene for L-gulonogamma-lactone oxidase, the key enzyme for L-ascorbic acid biosynthesis missing in this species." Journal of Biological Chemistry 267: 21967-21972. [\[PubMed\]](#)

- Obiechina, A. E., Arotiba, J. T., and Fasola, A. O. (2001) "Third molar impaction: evaluation of the symptoms and pattern of impaction of mandibular third molar teeth in Nigerians." *Odontostomatol Trop* 24: 22-25. [\[PubMed\]](#)
- Oetting, W. S., O. C. Stine, *et al.* (1993) "Evolution of the tyrosinase related gene (TYRL) in primates." *Pigment Cell Research* 6: 171-177. [\[PubMed\]](#)
- Ogawa, R., and Kamiya, T. A. (1957) "Case of the cachalot with protruded rudimentary hind limbs." *Sci. Rep. Whales Res. Inst.* No. 12.
- Ohta, Y. and Nishikimi, M. (1999) "Random nucleotide substitutions in primate nonfunctional gene for L-gulano-gamma-lactone oxidase, the missing enzyme in L-ascorbic acid biosynthesis." *Biochimica et Biophysica Acta* 1472: 408-411. [\[PubMed\]](#)
- Perkins, R., Schofferman, J., and Reynolds, J. (2003) "Coccygectomy for severe refractory sacrococcygeal joint pain." *J Spinal Disord Tech* 16: 100-103. [\[PubMed\]](#)
- Postacchini, F., and Massobrio, M. (1983) "Idiopathic coccygodynia. Analysis of fifty-one operative cases and a radiographic study of the normal coccyx." *J Bone Joint Surg Am* 65: 1116-1124. [\[PubMed\]](#)
- Prinos, P., Joseph, S., Oh, K., Meyer, B. I., Gruss, P., and Lohnes, D. (2001) "Multiple pathways governing *Cdx1* expression during murine development." *Dev Biol* 239: 257-269. [\[PubMed\]](#)
- Rakprasitkul, S. (2001) "Pathologic changes in the pericoronal tissues of unerupted third molars." *Quintessence Int.* 32: 633-638. [\[PubMed\]](#)
- Ramsey, M. L., Toohey, J. S., Neidre, A., Stromberg, L. J., and Roberts, D. A. (2003) "Coccygodynia: treatment." *Orthopedics* 26: 403-405. [\[PubMed\]](#)
- Raynaud, A. (1990) "Developmental mechanism involved in the embryonic reduction of limbs in reptiles." *Int J Dev Biol* 34:233-243. [\[PubMed\]](#)
- Raynaud, A., and Kan, P. (1992) "DNA synthesis decline involved in the developmental arrest of the limb buds in the embryos of the slow worm, *Anguis fragilis* (L.)." *Int J Dev Biol* 36:303-310. [\[PubMed\]](#)
- Raynaud, A., and Van den Elzen, P. (1976) ["Rudimentary stages of the extremities of *Scelotes gronovii* (Daudin) embryos, a South African Scincidea reptile."] *Arch Anat Microsc Morphol Exp.* 65: 17-36. [\[PubMed\]](#)
- ReMine, W. and J. M. K. (anonymous) (1982) "Child recently born with a tail?" *Bible Science Newsletter* 20: 8.
- Roelink, H., Wang, J., Black, D. M., Solomon, E., and Nusse, R. (1993) "Molecular cloning and chromosomal localization to 17q21 of the human *WNT3* gene." *Genomics* 17: 790-792. [\[PubMed\]](#)
- Rouquier, S., A. Blancher, *et al.* (2000) "The olfactory receptor gene repertoire in primates and mouse:

Evidence for reduction of the functional fraction in primates." PNAS 97: 2870-2874. <http://www.pnas.org/cgi/content/full/97/6/2870>

Sarfati, J. (1999) "The non-evolution of the horse." Creation Ex Nihilo 21: 28-31. [AIG text](#)

Sarfati, J. (2002) "AiG misuses the term 'vestigial'? (response to critic)" [Answers in Genesis Feedback Response](#).

Sapunar, D., Vilovic, K., England, M., and Saraga-Babic, M. (2001) "Morphological diversity of dying cells during regression of the human tail." Ann Anat 183: 217-222. [PubMed](#)

Saraga-Babic, M., Lehtonen, E., Svajger, A., and Wartiovaara, J. (1994) "Morphological and immunohistochemical characteristics of axial structures in the transitory human tail." Anat Anz. 176: 277-286. [PubMed](#)

Saraga-Babic, M., Stefanovic, V., Saraga, M., Wartiovaara, J., and Lehtonen, E. (2002) "Expression of intermediate filaments and desmosomal proteins during differentiation of the human spinal cord." Acta Histochem. 104: 157-166. [PubMed](#)

Scadding, S. R. (1981) "Do 'vestigial organs' provide evidence of evolution?" Evolutionary Theory 5: 173-176.

Scadding S. R., and Maden, M. (1994) "Retinoic acid gradients during limb regeneration." Dev Biol 162: 608-617. [PubMed](#)

Schersten, E., Lysell, L., and Rohlin, M. (1989) "Prevalence of impacted third molars in dental students." Swed Dent J. 13: 7-13. [PubMed](#)

Schubert, M., Holland, L. Z., Stokes, M. D., and Holland, N. D. (2001) "Three amphioxus Wnt genes (AmphiWnt3, AmphiWnt5, and AmphiWnt6) associated with the tail bud: the evolution of somitogenesis in chordates." Dev Biol 240: 262-273. [PubMed](#)

Sedmera, D., Misek, I., and Klima, M. (1997) "On the development of Cetacean extremities: I. Hind limb rudimentation in the Spotted dolphin *Stenella attenuata*." Eur J Morphol 35: 25-30. [PubMed](#)

Shaposhnikov, V. I. (1997) "Surgical treatment of coccygodynia." Khirurgiia (Mosk). 9: 47-48. [PubMed](#)

Shum, A. S., Poon, L. L., Tang, W. W., Koide, T., Chan, B. W., Leung, Y. C., Shiroishi, T., and Copp, A. J. (1999) "Retinoic acid induces down-regulation of Wnt-3a, apoptosis and diversion of tail bud cells to a neural fate in the mouse embryo." Mech Dev 84: 17-30. [PubMed](#)

Sleptsov, M. M. (1939) "On the asymmetry of the skull of *Odontoceti*." Zoologicheskii Zhurnal 18(3).

Spiegelmann, R., Schinder, E. Mintz, M., and Blakstein., A. (1985) "The human tail: a benign stigma." J. Neurosurgery 63:461-462. [PubMed](#)

Standfast, A. L. (1992) "The human tail." *New York State Journal of Medicine*. 92: 116. [\[PubMed\]](#)

Strickberger (2000) **Evolution**. Third edition. Sudbury, MA: Jones and Bartlett.

Sugumata, A., Sato, M., Ikeda, J., Kinoshita, J., Tanihira, S., and Makino, K. (1988) "Two cases of a true human tail." *Jpn J Plast Reconstr Surg* 31: 1072.

Takada, S., Stark, K. L., Shea, M. J., Vassileva, G., McMahon, J. A., and McMahon, A. P. (1994) "Wnt-3a regulates somite and tailbud formation in the mouse embryo." *Genes Dev* 8: 174-189. [\[PubMed\]](#)

Tevepaugh, D. B., and Dodson, T. B. (1995) "Are mandibular third molars a risk factor for angle fractures? A retrospective cohort study." *J Oral Maxillofac Surg*. 53: 646-649. [\[PubMed\]](#)

Touraine, A. (1955) **L'homme et sa descendance**. Masson, Paris.

Tyndale-Biscoe, H. and Renfree, M. (1987) **Reproductive Physiology of Marsupials**. Cambridge University Press.

Weismann, A. (1886) "IX. Retrogressive Development in Nature." reproduced in **Essays upon Heredity and Kindred Biological Problems**. Volume II. Poulton, E. B. and Shipley, A. E., editors., Clarendon Press: Oxford. 1892.

Wieland, C. (1998) "The strange tale of the leg on the whale." *Creation Ex Nihilo* 20: 10-13. <http://www.answersingenesis.org/docs/3316.asp>

Wiedersheim, R. (1893) **The Structure of Man: An Index to His Past History**. Second Edition. Translated by H. and M. Bernard. London: Macmillan and Co. 1895.

Woodburne, M. O., and Case, J. A. (1996) "Dispersal, vicariance, and the Late Cretaceous to Early Tertiary land mammal biogeography from South America to Australia." *Journal of Mammalian Evolution* 3: 121-161.

Wray, C. C., Easom, S., and Hoskinson, J. (1991) "Coccydynia. Aetiology and treatment." *J Bone Joint Surg Br* 73: 335-338. [\[PubMed\]](#)

Zembskii, V. A., and Berzin, A. A. (1961) "On the rare phenomenon of atavism in the sperm whale." *Nauchnye Doklady Vysshei Shkoly*. Series "Biologicheskie Nauki."

[Full references](#)

[Glossary](#)



[Previous](#)

[Contents](#)

[Next](#)

Home	Browse	Search	Feedback	Links
The FAQ		Must-Read Files		Index
Evolution		Creationism		Age of the Earth
Flood Geology		Catastrophism		Debates

[Home Page](#) | [Browse](#) | [Search](#) | [Feedback](#) | [Links](#)



[The FAQ](#) | [Must-Read Files](#) | [Index](#) | [Creationism](#) | [Evolution](#) | [Age of the Earth](#) | [Flood Geology](#) | [Catastrophism](#) | [Debates](#)



## 29+ Evidences for Macroevolution

### Part 3: Opportunism and Evolutionary Constraint

Copyright © 1999-2004 by [Douglas Theobald, Ph.D.](#)

---



[Previous](#)

[Contents](#)

[Next](#)

"You have loaded yourself with an unnecessary difficulty in adopting *Natura non facit saltum* so unreservedly."

- T. H. Huxley,  
*to Darwin* ([Huxley 1900](#), 2:27)

**T**he principle of evolutionary opportunism is closely related to evolutionary history and to the effects of contingency (some authors refer to the concept of opportunism as "the principle of continuity") ([Crick 1968](#)). Descent with gradual modification means that new organisms can only use and modify what they initially are given; they are slaves to their history. New structures and functions must be recruited from previous, older structures ([Futuyma 1998](#), pp. 110, 671-674). This is because structures, as opposed to functions, are strictly inherited. True unprecedented structural novelty should be very rare. This provides extreme constraints on the possible paths of evolution, as Huxley well noted in the quote above.

#### Part 3 Outline

1. [Morphological parahomology](#)
2. [Molecular parahomology](#)
3. [Morphological analogy](#)
4. [Molecular analogy](#)
5. [Morphological suboptimality](#)
6. [Molecular suboptimality](#)

- [Irreducible complexity and suboptimality](#)

## Prediction 3.1: Anatomical parahomology

*"Let the waters", it is said, "bring forth abundantly moving creature that hath life and fowl that may fly above the earth in the open firmament of heaven." Why do the waters give birth also to birds? Because there is, so to say, a family link between the creatures that fly and those that swim. In the same way that fish cut the waters, using their fins to carry them forward and their tails to direct their movements round and round and straightforward, so we see birds float in the air by the help of their wings. Both endowed with the property of swimming, their common derivation from the waters has made them of one family.*

- St. Basil, Bishop of Caesarea, 329-379 A.D.  
from [The Hexaemeron: Homily VIII.- The Creation of Fowl and Water Animals.](#)  
making one of the earliest known inferences to common descent from biostructural similarity.

One major consequence of the constraint of gradualism is the predicted existence of [parahomology](#). Parahomology, as the term is used here, is similarity of structure despite difference in function. When one species branches into two species, one or both of the species may acquire new functions. Since the new species must recruit and modify preexisting structures to perform these new functions, the same structure shared by these two species will now perform a different function in each of the two species. This is parahomology. It follows that parahomologous structures have a history that should be explicable from other lines of evolutionary evidence, since derived characteristics (which is what these new functions and structures now are) have evolved from more primitive (i.e. older) structures. Consequently, detailed and explicit predictions can be made about the possible morphologies of fossil intermediates.

### Confirmation:

There are countless examples of parahomology in living and extinct species – the same bones in the same relative positions are used in primate hands, bat wings, bird wings, pterosaur wings, whale and penguin flippers, horse legs, the digging forelimbs of moles, and webbed amphibian legs. All of these characters have similar structures that perform various different functions. The standard phylogenetic tree shows why these species have these same structures, i.e. they have common ancestors that had these structures. This is the conclusion supported by the phylogenetic tree, even though these parahomologous characters were not used to





group these species together. Viewed objectively, this is truly a remarkable result, since only shared derived characters, which have the same structure and function, determine which species are grouped together in a phylogeny (refer to the explanation of [cladistic methodology](#) for more discussion).

Additionally, independent evidence from the fossil record has confirmed that many of those structures were derived from others. The fossil record shows a general chronological progression of intermediate forms between theropod dinosaurs and modern birds, in which theropod structures were modified into modern bird structures ([Carroll 1988](#); [Carroll 1997](#); [Serenó 1999](#)). This series is exemplified by *Eoraptor* (~230 Mya), the Herrerasauridae (~230-210 Mya), the Ceratosauria (~220-65 Mya), the Allosauroida (180-90 Mya), the Deinonychosauria (150-65 Mya), *Archaeopteryx* (~150 Mya), the Confuciusornithidae (145 Mya), the Enantiornithes (145 Mya-65 Mya), and the Euornithes (65 Mya-recent) ([Serenó 1999](#)). Figure 3.1.1 shows the forelimbs of four representative intermediates of the avian lineage ([Carroll 1988](#), p. 340; [Carroll 1997](#), p. 309).

### Potential Falsification:

The fossil record could show a chronological progression in which bird wings are gradually transformed into reptilian arms; however, the opposite is the case. Additionally, a strong falsification would be if it were positively demonstrated that the primitive structures of an organism's predicted ancestors could not be reasonably modified into the modern organism's derived structures. A clear fanciful example, though completely serious, is the macroevolutionary impossibility of ever finding an animal such as a Pegasus. Since a Pegasus would be a mammal closely related to the horse, its wings would be considered derived characters. However, Pegasus wings cannot be modifications of its ancestors' structures, since the immediate predicted ancestors of Pegasus and horses had no possible structures there to modify ([Futuyma 1998](#), p. 110).

Analogously, we predict that we should never find birds with both wings and arms, or mollusks harboring chloroplasts, even though these structures could be quite useful for these organisms. Equivalently, it would be a strong falsification if the phylogenetic tree had no structural continuity, but rather had functional continuity or had no recognizable continuity of any kind. Also see the falsification for [prediction 3.4](#).

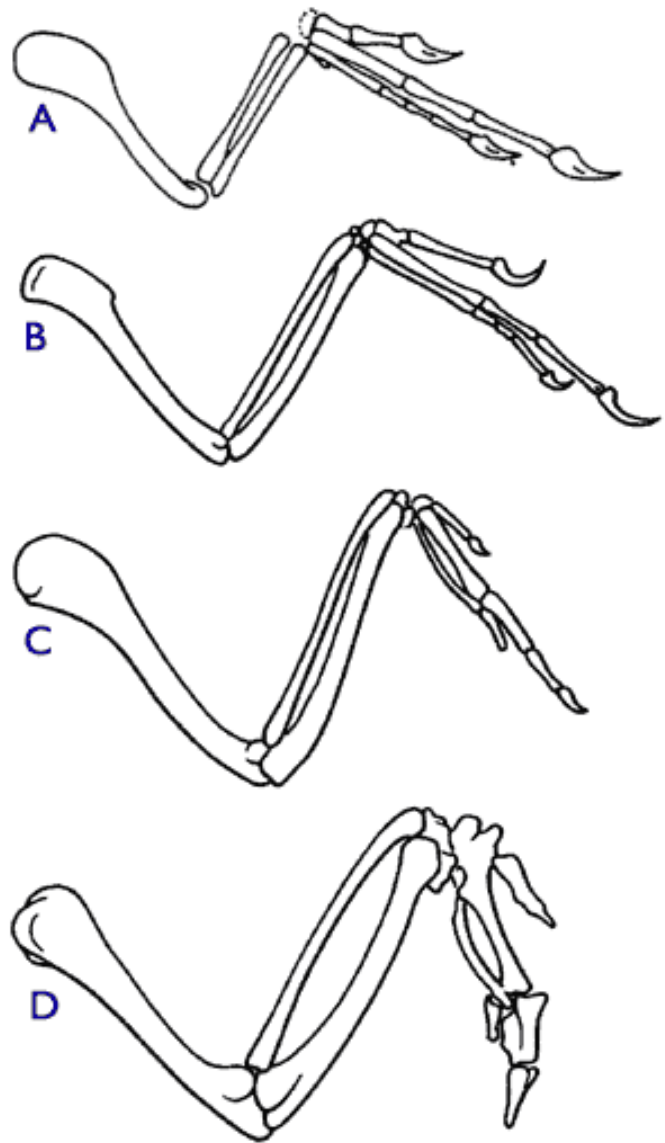

**Figure 3.1.1. Comparison of the forelimbs of various relatives of modern birds.** Forelimbs of (A) *Ornitholestes*, a theropod dinosaur, (B) *Archaeopteryx*, (C) *Sinornis*, an archaic bird from the lower Cretaceous, and (D) the wing of a modern chicken (modified from Carroll 1988, p. 340; [Carroll 1997](#), p. 309).

## Prediction 3.2: Molecular parahomology

The concept of [parahomology](#) applies equally to both the macroscopic structures of organisms and structures on the molecular level.

### Confirmation:

On the molecular level, the existence of parahomology is quite impressive. Many proteins of very different function have strikingly similar amino acid sequences and three-dimensional structures. A frequently cited example is lysozyme and  $\alpha$ -lactalbumin. Almost all animals have lysozyme. It is a secreted protein used to degrade bacterial cell walls as a means of defense ([Voet and Voet 1995](#), p. 381).  $\alpha$ -Lactalbumin is very similar structurally to lysozyme, even though its function is very different (it is involved in mammalian lactose synthesis in the mammary gland) ([Acharya et al. 1989](#); [Voet and Voet 1995](#), p. 608). It can often be inferred from molecular phylogenies, as it has been here, that the protein with the more basic function (e.g. lysozyme) is also the older protein ([Prager and Wilson 1988](#); [Qasba and Kumar 1997](#)).

On a grander scale, a stunning confirmation of these evolutionary predictions has come from an analysis of [Saccharomyces cerevisiae](#) (baker's yeast) and [Caenorhabditis elegans](#) (a worm). The genomes of both these organisms were sequenced very recently ([Barrell 1996](#); [Caenorhabditis elegans Sequencing Consortium 1998](#)). The genes used by the yeast, a unicellular organism, are mostly genes dealing directly with core biochemical functions that all organisms must perform. From an evolutionary perspective, we would expect these genes to be ancient. Thus it was expected and shown that the worm contains a great majority of these genes. In contrast, the extra genes used by the worm, which deal with multicellularity, should be more recently evolved. Phylogenetic analysis has shown that this is exactly the case. The vast majority of extra genes in the worm appear to be directly derived from genes providing core cellular functions, in accordance with evolutionary prediction ([Chervitz et al. 1998](#)).

An even larger study of the known eukaryotic genomes has further demonstrated that parahomology is rampant in nature, and that true structural innovation is relatively rare ([Rubin et al. 2000](#)). In a special issue of the leading scientific journal *Science*, over fifty researchers reviewed the content of the entire sequenced genomes of *Drosophila melanogaster*, *Caenorhabditis elegans*, *Saccharomyces cerevisiae*, and humans (an insect, a worm, a unicellular fungus, and a mammal respectively - a very wide range of disparate taxa). There are around 18,000 identifiable genes in *Caenorhabditis elegans* (an important model laboratory organism), of which half are duplications of other genes in the same genome. Similarly, forty percent of the insect's genome are redundant genes. From sequence comparisons, on average 70% of any organism's genes are shared with the other organisms - indicating that most genes have been reused throughout evolution for different functions in these different organisms. This figure is certainly an underestimate, since very many proteins are known that have the same three-dimensional structure, yet this similarity is undetectable from sequence comparisons alone (an expected consequence of the massive structural and functional redundancy of proteins and nucleic acids, discussed more thoroughly in [predictions 4.1](#) and [4.2](#)). Strikingly, some fruit flies which are nearly morphologically indistinguishable (such as *Drosophila melanogaster* and *Drosophila virilis*) also have an apparent genomic similarity of only 70% ([Schmid and Tautz 1997](#)). In the final analysis, there has been very little true structural or genomic innovation during the evolution of eukaryotes, as most genes have simply been duplicated and/or reused, with minor modification, either in the same organism or in different organisms. Furthermore, the level of dissimilarity between organisms (~30%, likely reflecting the amount of genetic evolution that separates them) is apparently accountable by gradual microevolutionary processes like those that led to the divergence of various species of fruitflies.

## Potential Falsification:

Proteins performing more recently evolved functions should have statistically significant similarities with proteins performing core functions. It is evolutionarily problematic if they do not. Furthermore, it would be inconsistent with evolutionary theory if we had found that genes involved in multicellular functions were more deeply rooted in their phylogenies (i.e. if these genes were more ancient than the core function genes) ([Li 1997](#); [Chervitz et al. 1998](#)).

## Prediction 3.3: Anatomical analogy

A corollary of the principle of evolutionary opportunism is analogy. Analogy is the case where different structures perform the same or similar functions in different species. Two distinct species have different histories and different structures; if both species evolve the same new function, they may recruit different structures to perform this new function. Analogy also must conform to the principle of structural continuity; analogy must be explained in terms of the structures of predicted ancestors.

## Confirmation:

There are many anatomical examples of functional analogy. One case is the vertebrate eye and the cephalopod eye. Another, mentioned earlier, is the case of American and Saharan desert plants, which use different structures for the same functions needed to live in dry, arid regions. Certain mammals (whales, manatees, dolphins), birds (penguins), and fish all have the ability to live and swim in aquatic environments, and they obviously use different structures overall for these aquatic functions. Although now modified, all of the structures that perform these functions were also present in their predicted ancestors.

## Potential Falsification:

We would not expect newly discovered species of dolphins, whales, penguins, or any close mammalian relatives to have gills (a possible analogy with fish), since their immediate ancestors lacked gills or gill-like structures from which they could be derived. This is the macroevolutionary prediction, in spite of the fact that gills would be extremely advantageous for aquatic mammals and birds. Also see the falsification below for molecular analogy, [point 14](#).

## Prediction 3.4: Molecular analogy

Like [parahomology](#), [analogy](#) should be represented on both macroscopic and molecular levels.

## Confirmation:

A familiar molecular example is the case of the three proteases subtilisin, carboxy peptidase II, and chymotrypsin. These three proteins are all serine proteases (i.e. they degrade other proteins in digestion). They have the same function, the same catalytic residues in their active sites, and they have the same catalytic mechanism. Yet they have no sequence or structural similarity ([Voet and Voet 1995](#), p. 394).

Another molecular example is that of DNA polymerases. DNA polymerases are the proteins that catalyze the duplication of a strand of DNA; i.e. they catalyze multiple additions of nucleotides to a DNA strand.

All the structures determined for DNA polymerases have clear structural similarity except for one, rat polymerase  $\beta$  ([Davies et al. 1994](#); [Voet and Voet 1995](#), p. 1040). Except for rat polymerase  $\beta$ , all the DNA polymerases are most likely related by divergent evolution. Rat polymerase  $\beta$  has structural similarity with nucleotidyl transferases, which catalyze the addition of one nucleotide to a DNA strand. Rat polymerase  $\beta$  has obviously evolved from nucleotidyl transferases by mutating to catalyze several nucleotide additions instead of just one (which nicely illustrates why analogy is ultimately also parahomology) ([Aravind and Koonin 1999](#)).

### Potential Falsification:

Parahomology and analogy are specific predictions of macroevolution and the principle of evolutionary opportunism. It is possible that a world could exist where there were no cases of biological parahomology or analogy. For example, living organisms could be constructed in a modular manner, like most anthropogenic creations, where each specific structure performs one specific function.

### Prediction 3.5: Anatomical suboptimality

Evolutionary opportunism also results in suboptimal functions and structures. As stated before, in gradually evolving a new function, organisms must make do with what they already have. Thus, functions are likely to be performed by structures that would have been arranged differently (e.g. more efficiently) if the final function were known from the outset. "Suboptimality" does not mean that a structure functions poorly. It simply means that a structure with a more efficient design (usually with less superfluous complexity), could perform the same final function equally well. Suboptimal structures and functions should have a gradualistic, historical evolutionary explanation, based on the opportunistic recruitment of ancestral structures, if this history is known from other evidence (e.g. if this history is phylogenetically determined by closely related organisms or fossil history).

### Confirmation: Suboptimality and Irreducible Complexity

The appearance of suboptimal function is intimately related to the inference of Intelligent Design. Obviously, there are many inefficient ways to perform any given function; however, some functions are performed very efficiently. Those structures that perform extremely efficient functions are often intelligently designed. Similarly, we often think of the best designer as the one who designs a structure to perform a function the most elegantly, the most efficiently, and with the least needless complexity.

In the terms of the Intelligent Design advocate Michael Behe, one measure of efficiency of design (whether real or apparent) is irreducible complexity. Here are Behe's own words – "By irreducibly complex (IC) I mean a single system composed of several well-matched, interacting parts that contribute to the basic function, wherein the removal of any one of the parts causes the system to effectively cease functioning." ([Behe 1996](#), p. 39, emphasis in the original, my parentheses).

An equivalent way of stating the evolutionary prediction of suboptimal function is that *many biological systems should not be irreducibly complex*. Furthermore, in most biological cases *an irreducibly complex system will not be the simplest irreducibly complex system that could perform the same function*. For instance, the same function may be performed by two systems of unequal complexity in two different organisms. Comparative molecular biology has demonstrated that many non-redundant genetic systems (i.e. IC systems) in one given species indeed are performed by more simple systems in other organisms. Furthermore, in innumerable cases many, if not most, biological systems are in fact genetically redundant (i.e. they are not IC).

**Note:** The above point is not a refutation of Behe's central argument that very complex IC systems are difficult to evolve gradually ([Behe 1996](#), p. 40). Nevertheless, Behe's thesis is not a rigorous scientific hypothesis, because it is very difficult, if

not impossible, to marshal positive supporting evidence. One can positively establish that a system is not IC by removing a part and maintaining function. One can positively establish that a given system is not the simplest IC system by observing a functionally equivalent system with fewer parts in another organism. However, one cannot demonstrate that it is impossible to gradually evolve a certain IC system. This problem is especially grave since Behe readily admits that IC systems *can* evolve gradually (e.g. hemoglobin) ([Behe 1996](#), pp. 40, 206-207). In fact, given enough iterations of evolutionary selection, there is theoretically a functional gradual path to any IC structure ([Behe 1996](#), p. 40; [Thornhill and Ussery 2000](#)). Behe's thesis thus boils down to a question of time, not of possibility. Despite this fact, Behe never considers evolutionary time constraints or rates of gradual evolution. For a consideration of the time necessary for observed evolutionary changes, see [prediction 5.7](#) and [prediction 5.8](#).

The mammalian gastrointestinal tract crosses the respiratory system. Functionally, this is suboptimal; it would be beneficial if we could breathe and swallow simultaneously. Unfortunately, we cannot, and this is why we are susceptible to death by choking. However, there is a good historical evolutionary reason for this arrangement. The *Osteolepiformes* (Devonian lungfish), from which mammals evolved, swallowed air to breathe. Only later did the ancestors of mammals recruit the olfactory nares of fish for the function of breathing on land. It so happens that the nares (originally used only for smelling) are on the opposite side of the esophagus from the lungs ([Futuyma 1998](#), p. 5). Humans have inherited this original design, even though it now causes problems.

Another anatomical example of suboptimality is the inverted mammalian retina, with its blind spot. It is inverted because the retinal blood vessels and nerves are situated on top of the retina, and light must travel through them first before hitting the light sensitive cells below. The blind spot is caused by the hole where the nerves all meet and pierce through the retina to travel to the brain. In order to deal with the many problems inherent in an inverted retina, the vertebrate eye utilizes various complex compensatory structures and mechanisms (e.g. foveas and slower, more transparent unmyelinated nerves).

Cephalopods (e.g. squids and octopi) have eyes with a similar form based on the same mechanistic principles as mammalian eyes. However, in contrast with mammalian eyes, cephalopod eyes have very different underlying retinal structures (e.g. they are verted, not inverted), and they have no blind spots ([Goldsmith 1990](#); [Williams 1992](#), pp. 72-74). This strongly suggests that mammals also could have eyes without blind spots.

There are many other examples of suboptimal function in the [Jury-rigged Design FAQ](#).

### Potential Falsification:

A strong positive falsification would be the discovery of a mammal without crossed gastrointestinal and respiratory tracts, or a reptile or mammal without blindspots in its eyes, etc. This is because poor design cannot be "fixed" by evolutionary processes, even if correcting the problem would be beneficial for the organism. The only "fixing" that is allowed evolutionarily is relatively minor modification of what already exists.

**Note:** Members of this class of argument could conceivably be nullified if a presumed suboptimal structure were in fact found to be functionally efficient. However, for most examples, finding an important function for the specific structural arrangement does not alter the basic conclusion. For example, perhaps the retinal blind spot in vertebrates is actually necessary for an important function, or perhaps it has a presently unknown function specific to land animals. In fact, some anti-evolutionists have proposed that the complex inverted vertebrate eye, with its blind spot, is required for terrestrial life, while the more efficient cephalopod verted eye is sufficient for murky underwater vision ([Bergman 2000](#)). But then the question arises—why do vertebrate fish have inverted eyes? For fish, the vertebrate

eye plan with its additional needless complexity is suboptimal, since the more elegant, more efficient, less complex cephalopod eye could perform underwater functions equally as well. The suboptimality argument has not been refuted; the emphasis has merely been shifted from one organism to another. Moreover, the macroevolutionary hypothesis would still be potentially falsified by the discovery of vertebrate bony fish with verted eyes. For more information see the "[Suboptimality and Irreducible Complexity](#)" box.

### Prediction 3.6: Molecular suboptimality

The principle of imperfect design should apply to biomolecular organization as well.

#### Confirmation:

With the recent sequencing of the human genome, we have found that less than 2% of the DNA in the human genome is used for making proteins (International Human Genome Sequencing Consortium 2001, p. 900). A full 45% of our genome is composed of transposons, which serve no known function for the individual (except to cause a significant fraction of genetic illnesses and cancers) ([Deininger and Batzer 1999](#); [Ostertag and Kazazian 2001](#)). One retrotransposon, LINE1, constitutes a full 17% of the human genome ([Ostertag and Kazazian 2001](#); [Smit 1996](#), [IHGSC 2001](#), p. 879-882). All specific individual Alu transposons tested so far have been shown to be nonfunctional ([Deininger and Batzer 1999](#)). Thus, even if these genetic elements in fact provide a *bona fide* function as a whole, they would remain some of the most inefficient genes known in all of biology due to thier excessive number and their known propensity to cause illnesses.



**Figure 3.6.1. *Paramecium aurelia* and *Paramecium caudatum*.** *Paramecium caudatum* (shown at right) has 45 times the amount of DNA in its genome as *Paramecium aurelia* (shown at left).

Approximately 20% of the human genome is composed of pseudogenes, the majority of which serve no function for the individual. A remarkable example is the glyceraldehyde-3-phosphate dehydrogenase (GDPH) gene. In humans, there is one functional GDPH gene, but there are at least twenty GDPH pseudogenes. In mice, there are approximately 200 GDPH pseudogenes. In addition to one or two functional copies, there are between 20 and 30 pseudogenes of cytochrome *c* in both humans and the rat ([Li 1997](#), p. 349).

The majority of eukaryotic genes coding for functional proteins are interrupted by noncoding sequences called introns. Introns must be cut out before the information contained in the gene can be used to make protein. Introns make up 80% of the average vertebrate gene ([Voet and Voet 1995](#), p. 1144). Similar to transposons, most introns serve no purpose (in rare cases they are involved in gene regulation or code for a functional RNA).

The rest of the DNA in a eukaryotic genome is mostly short repetitive sequences such as AAAAAA, CACACA, or CGGCGGCGG (IHGSC

*Paramecium caudatum*'s genome is also three times as large as yours (assuming you are a human, that is).

2001, p. 879). It appears that there is no efficient mechanism for ridding most metazoan (animal) genomes of extraneous DNA; once extra DNA is introduced into the genome of an animal, it is there

to stay.

Even protists, unicellular organisms, are subject to such evolutionary jury-rigging. Two ciliates, *Paramecium aurelia* and *Paramecium caudatum*, are virtually indistinguishable from morphological and phenotypic analysis (see Figure 3.6.1). However, the first has less than 200,000 kb of DNA in its genome, whereas the genome of the second has nearly 9,000,000 kb of DNA, which is evidently at least 45 times the amount it actually needs (Li 1997, p. 383). Note also that *Paramecium caudatum*, a single-celled organism, has about three times the DNA as a human.

A lot of energy is expended in dealing with this excess DNA; however, all these molecular examples also have convincing explanations based on evolutionary histories. See the molecular evidence in [predictions 4.3-4.5](#) for more information (Li 1997).

### Potential Falsification:

Because evolution has no foresight, and cannot plan for future functions, it would be extremely suspicious if biological molecular systems were efficiently designed. Again, this does not rule out complexity - merely efficiency of mechanism.



### References

- Acharya, K. R., D. I. Stuart, *et al.* (1989) "Refined structure of baboon alpha-lactalbumin at 1.7 Å resolution - comparison with c-type lysozyme." *Journal of Molecular Biology* 208: 99-127. [\[PubMed\]](#)
- Aravind, L., and Koonin, E. V. (1999) "DNA polymerase beta-like nucleotidyl transferase superfamily: identification of three new families, classification, and evolutionary history." *Nucleic Acids Research* 27: 1609. <http://nar.oupjournals.org/cgi/content/full/27/7/1609>
- Barrell, B. G., *et al.* (1996) "Life with 6000 genes." *Science* 274: 546-567. [\[PubMed\]](#)
- Behe, M. (1996) **Darwin's Black Box**. New York, Touchstone.
- Bergman, J. (2000) "Is the inverted human eye a poor design?" *Perspectives on Science and Christian Faith* 52: 18-30. <http://www.asa3.org/ASA/PSCF/2000/PSCF3-00Bergman.html>
- Carroll, R. L. (1988) **Vertebrate Paleontology and Evolution**. New York, W. H. Freeman and Co.
- Carroll, R. L. (1997) **Patterns and Processes of Vertebrate Evolution**. Cambridge: Cambridge University Press.
- Chervitz, S. A., *et al.* (1998) "Comparison of the complete protein sets of worm and yeast: Orthology and divergence." *Science* 282: 2022-2028. [\[PubMed\]](#)

- Caenorhabditis elegans Sequencing Consortium (1998) "Genome sequence of the nematode *C. elegans*: A platform for investigating biology." *Science* 282: 2012-2018. [\[PubMed\]](#)
- Crick, F. H. C. (1968) "The origin of the genetic code." *Journal of Molecular Biology* 38: 367-379.
- Davies, J. C. I., R. J. Almassey, *et al.* (1994) "2.3 Å crystal structure of the catalytic domain of DNA polymerase beta." *Cell* 76: 1123-1133. [\[PubMed\]](#)
- Deininger, P. L., and Batzer, M. A. (1999) "Alu repeats and human disease." *Mol Genet Metab.* 67: 183-193. [\[PubMed\]](#)
- Futuyma, D. (1998) **Evolutionary Biology**. Third edition. Sunderland, MA, Sinauer Associates.
- Goldsmith, T. H. (1990) "Optimization, constraint, and history in the evolution of eyes." *Quarterly Review of Biology* 65: 281-322. [\[PubMed\]](#)
- Huxley, T. H. (1900) **Life and letters of Thomas Henry Huxley**. London, MacMillan.
- International Human Genome Sequencing Consortium (2001) "Initial sequencing and analysis of the human genome." *Nature* 409: 860-921. [http://www.nature.com/cgi-taf/DynaPage.taf?file=/nature/journal/v409/n6822/full/409860a0\\_fs.html](http://www.nature.com/cgi-taf/DynaPage.taf?file=/nature/journal/v409/n6822/full/409860a0_fs.html)
- Li, W.-H. (1997) **Molecular Evolution**. Sunderland, MA, Sinauer Associates.
- Ostertag, E.M., and Kazazian, H. H. (2001) "Biology of mammalian L1 retrotransposons." *Annu Rev Genet* 35: 501-538. [\[PubMed\]](#)
- Novick, G. E., Gonzalez, T., Garrison, J., Novick, C. C., Batzer, M. A., Deininger, P. L., Herrera, R. J. (1993) "The use of polymorphic Alu insertions in human DNA fingerprinting." *EXS.* 67: 283-291. [\[PubMed\]](#)
- Novick, G. E., Novick, C. C., Yunis, J., Yunis, E., Martinez, K., Duncan, G. G., Troup, G. M., Deininger, P. L., Stoneking, M., Batzer, M. A., *et al.* (1995) "Polymorphic human specific Alu insertions as markers for human identification." *Electrophoresis* 16: 1596-1601. [\[PubMed\]](#)
- Prager, E. M., and Wilson, A. C. (1988) "Ancient origin of lactalbumin from lysozyme: analysis of DNA and amino acid sequences." *Journal of Molecular Evolution* 27: 326-335. [\[PubMed\]](#)
- Qasba, P. K., and Kumar, S. (1997) "Molecular divergence of lysozymes and alpha lactalbumin." *Critical Review of Biochemistry and Molecular Biology* 32: 255-306. [\[PubMed\]](#)
- Rubin, G. M. *et al.* (2000) "Comparative Genomics of the Eukaryotes." *Science* 287: 2204-2218. [\[PubMed\]](#)
- Schmid, K. J., and Tautz, D. (1997) "A screen for fast evolving genes from *Drosophila*." *Proc. Natl. Acad. Sci. USA.* 94: 9746-9750. <http://www.pnas.org/cgi/content/full/94/18/9746>
- Sereno, P. C. (1999) "The Evolution of Dinosaurs." *Science* 284: 2137-2147. [\[PubMed\]](#)
- Smit, A. F. A. (1996) "The origin of interspersed repeats in the human genome." *Current Opinion in Genetics and Development* 6: 743-748. [\[PubMed\]](#)
- Thornhill, R. H., and Ussery, D. W. (2000) "A classification of possible routes of Darwinian evolution." *Journal of Theoretical Biology* 203: 111-116. [\[PubMed\]](#)



Voet, D., and Voet, J. (1995) **Biochemistry**. New York, John Wiley and Sons.

Williams, G. C. (1992) **Natural Selection: Domains, Levels, and Challenges**. New York, Oxford University Press.

[Full references](#)

[Glossary](#)

 -  -   
[Previous](#)   [Contents](#)   [Next](#)

Home	Browse	Search	Feedback	Links
The FAQ		Must-Read Files		Index
Evolution		Creationism		Age of the Earth
Flood Geology		Catastrophism		Debates

[Home Page](#) | [Browse](#) | [Search](#) | [Feedback](#) | [Links](#)

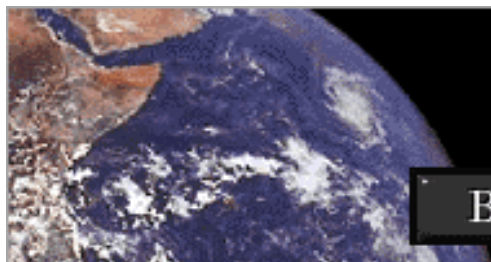

[The FAQ](#) | [Must-Read Files](#) | [Index](#) | [Creationism](#) | [Evolution](#) | [Age of the Earth](#) | [Flood Geology](#) | [Catastrophism](#) | [Debates](#)

[Browse](#)[Search](#)[Feedback](#)[Links](#)

## 29+ Evidences for Macroevolution

### Part 4: The Molecular Sequence Evidence

Copyright © 1999-2004 by [Douglas Theobald, Ph.D.](#)

---

[←](#) - [↑](#) - [→](#)  
[Previous](#)   [Contents](#)   [Next](#)

"We have obtained estimates of genetic differentiation between humans and the great apes no greater than, say, those observed between physically indistinguishable sibling species of fruit flies."

Elizabeth J. Bruce and Francisco J. Ayala  
*"Humans And Apes Are Genetically Very Similar,"*  
Nature 276:264, Nov. 16, 1978

**T**he molecular sequence evidence gives the most impressive and irrefutable evidence for the genealogical relatedness of all life. The nature of molecular sequences allows for extremely impressive probability calculations that demonstrate how well the predictions of common descent with modification actually match empirical observation. Common descent is a deduction that directly follows from premises based on empirically observed molecular evidence. In addition, knowledge of biological molecular mechanisms and structures, combined with macroevolutionary theory, has given very specific, novel, and testable biomolecular predictions.

#### Part 4 Outline

1. [Protein functional redundancy](#)
2. [DNA functional redundancy](#)
3. [Transposons](#)
4. [Redundant pseudogenes](#)
5. [Endogenous retroviruses](#)

## Prediction 4.1: Protein functional redundancy

The support for common descent given by studies of molecular sequences can be phrased as a deductive argument. This argument is unique within this FAQ, as it is the only instance we can directly conclude that similarity implies relatedness. This conclusion depends upon the similarity of biological structures within a specific context: the similarity observed between ubiquitous genes from different species.

The following discussion is somewhat technical, so it is first presented in the outline of a deductive argument, which makes the logical thread easy to follow. Here are listed the premises of the argument followed by the conclusion and further discussion.

### The gist of the argument:

(P1) **Ubiquitous genes:** There are certain genes that all living organisms have because they perform very basic life functions; these genes are called *ubiquitous genes*.

(P2) **Ubiquitous genes are uncorrelated with species-specific phenotypes:** Ubiquitous genes have no relationship with the specific functions of different species. For example, it doesn't matter whether you are a bacterium, a human, a frog, a whale, a hummingbird, a slug, a fungus, or a sea anemone - you have these ubiquitous genes, and they all perform the same basic biological function no matter what you are.

(P3) **Molecular sequences of ubiquitous genes are functionally redundant:** Any given ubiquitous protein has an extremely large number of different functionally equivalent forms (i.e. protein sequences which can perform the same biochemical function).

(P4) **Specific ubiquitous genes are unnecessary in any given species:** Obviously, there is no *a priori* reason why every organism should have the same sequence or even similar sequences. No *specific* sequence is functionally necessary in any organism - all that is necessary is one of the large number of functionally equivalent forms of a given ubiquitous gene or protein.

(P5) **Heredity correlates sequences, even in the absence of functional necessity:** There is one, and only one, observed mechanism which causes two different organisms to have ubiquitous proteins with similar sequences (aside from the extreme improbability of pure chance, of course). That mechanism is heredity.

(C) **Thus, similar ubiquitous genes indicate genealogical relationship:** It follows that organisms which have similar sequences for ubiquitous proteins are genealogically related. Roughly, the more similar the sequences, the closer the genealogical relationship.

## Discussion:

The amino acid sequences of proteins are often used to establish the phylogenetic relationships of species. Sequence studies with functional genes have centered on genes of proteins (or RNAs) that are ubiquitous (i.e. all organisms have them). This is done to insure that the comparisons are independent of the overall species phenotype.

For example, suppose we are comparing the protein sequence of a chimpanzee and that of a human. Both of these animals have many similar anatomical characters and functions, so we might expect their proteins to be similar too, regardless of whether they are genealogically related or not. However, we can compare the sequences of very basic genes that are used by all living organisms, such as the cytochrome *c* gene, which have no influence over specific chimpanzee or human characteristics.

Cytochrome *c* is an essential and ubiquitous protein found in all organisms, including eukaryotes and bacteria ([Voet and Voet 1995](#), p. 24). The mitochondria of cells contain cytochrome *c*, where it transports electrons in the fundamental metabolic process of oxidative phosphorylation. The oxygen we breathe is used to generate energy in this process ([Voet and Voet 1995](#), pp. 577-582).

Using a ubiquitous gene such as cytochrome *c*, there is no reason to assume that two different organisms should have the same protein sequence or even similar protein sequences, unless the two organisms are genealogically related. This is due in part to the functional redundancy of protein sequences and structures. Here, "functional redundancy" indicates that many different protein sequences form the same general structure and perform the same general biological role. Cytochrome *c* is an extremely functionally redundant protein, because many dissimilar sequences all form cytochrome *c* electron transport proteins. Functional redundancy need not be exact in terms of performance; some functional cytochrome *c* sequences may be slightly better at electron transport than others.

Decades of biochemical evidence have shown that many amino acid mutations, especially of surface residues, have only small effects on protein function and on protein structure

([Branden and Tooze 1999](#), Ch. 3; [Harris et al. 1956](#); [Lesk 2001](#), Chs. 5 and 6, pp. 165-228; [Li 1997](#), p. 2; [Matthews 1996](#)). A striking example is that of the *c*-type cytochromes from various bacteria, which have virtually no sequence similarity. Nevertheless, they all fold into the same three-dimensional structure, and they all perform the same biological role ([Moore and Pettigrew 1990](#), pp. 161-223; [Ptitsyn 1998](#)).

Even within species, most amino acid mutations are functionally silent. For example, there are at least 250 different amino acid mutations known in human hemoglobin, carried by more than 3% of the world's population, that have no clinical manifestation in either heterozygotic or homozygotic individuals ([Bunn and Forget 1986](#); [Voet and Voet 1995](#), p. 235). The phenomenon of protein functional redundancy is very general, and is observed in all known proteins and genes.

With this in mind, consider again the molecular sequences of cytochrome *c*. Cytochrome *c* is absolutely essential for life - organisms that lack it cannot live. It has been shown that the human cytochrome *c* protein works in yeast (a unicellular organism) that has had its own native cytochrome *c* gene deleted, even though yeast cytochrome *c* differs from human cytochrome *c* over 40% of the protein ([Tanaka et al. 1988a](#); [Tanaka et al. 1988b](#); [Wallace and Tanaka 1994](#)). In fact, the cytochrome *c* genes from tuna (fish), pigeon (bird), horse (mammal), *Drosophila* fly (insect), and rat (mammal) all function in yeast that lack their own native yeast cytochrome *c* ([Clements et al. 1989](#); [Hickey et al. 1991](#); [Koshy et al. 1992](#); [Scarpulla and Nye 1986](#)). Furthermore, extensive genetic analysis of cytochrome *c* has demonstrated that the majority of the protein sequence is unnecessary for its function *in vivo* ([Hampsey et al. 1986](#); [Hampsey et al. 1988](#)). Only about a third of the 100 amino acids in cytochrome *c* are necessary to specify its function. Most of the amino acids in cytochrome *c* are hypervariable (i.e. they can be replaced by a large number of functionally similar amino acids) ([Dickerson and Timkovich 1975](#)). Importantly, Hubert Yockey has done a careful study in which he calculated that there are a minimum of  $2.3 \times 10^{93}$  possible functional cytochrome *c* protein sequences, based on these genetic mutational analyses ([Hampsey et al. 1986](#); [Hampsey et al. 1988](#); [Yockey 1992](#), Ch. 6, p. 254). For perspective, the number  $10^{93}$  is about one billion times larger than the number of atoms in the visible universe. Thus, functional cytochrome *c* sequences are virtually unlimited in number, and there is no *a priori* reason for two different species to have the same, or even mildly similar, cytochrome *c* protein sequences.

In terms of a scientific statistical analysis, the "null hypothesis" is that the identity of non-essential amino acids in the cytochrome *c* proteins from human and chimpanzee should be random with respect to one another. However, from the theory of common descent and our standard phylogenetic tree we know that humans and chimpanzees are quite closely related. We therefore predict, in spite of the odds, that human and chimpanzee cytochrome *c* sequences should be much more similar than, say, human and yeast cytochrome *c* - simply due to inheritance.

## Confirmation:

Humans and chimpanzees have the exact same cytochrome *c* protein sequence. The "null hypothesis" given above is false. In the absence of common descent, the chance of this occurrence is conservatively less than  $10^{-93}$  (1 out of  $10^{93}$ ). Thus, the high degree of similarity in these proteins is a spectacular corroboration of the theory of common descent. Furthermore, human and chimpanzee cytochrome *c* proteins differ by ~10 amino acids from all other mammals. The chance of this occurring in the absence of a hereditary mechanism is less than  $10^{-29}$ . The yeast *Candida krusei* is one of the most distantly related eukaryotic organisms from humans. *Candida* has 51 amino acid differences from the human sequence. A conservative estimate of this probability is less than  $10^{-25}$ .

## Criticisms:

One possible, yet unlikely, objection is that the slight differences in functional performance between the various cytochromes could be responsible for this sequence similarity. This objection is unlikely because of the incredibly high number of nearly equivalent sequences that would be phenotypically indistinguishable for any required level of performance. Additionally, nearly similar sequences do not necessarily give nearly similar levels of performance.

Nonetheless, for the sake of argument, let us assume that a cytochrome *c* that transports electrons faster is required in organisms with active metabolisms or with high rates of muscle contraction. If this were true, we might expect to observe a pattern of sequence similarity that correlates with similarity of environment or with physiological requirement. However, this is not observed. For example, bat cytochrome *c* is much more similar to human cytochrome *c* than to hummingbird cytochrome *c*; porpoise cytochrome *c* is much more similar to human cytochrome *c* than to shark cytochrome *c*. As stated earlier in [prediction 1.3](#), the phylogenetic tree constructed from the cytochrome *c* data exactly recapitulates the relationships of major taxa as determined by the completely independent morphological data ([McLaughlin and Dayhoff 1973](#)). These facts only further support the idea that cytochrome *c* sequences are independent of phenotypic function (other than the obvious requirement for a functional cytochrome *c* that transports electrons).

## Recap:

The point of this prediction is subtly different from [prediction 1.3](#), "Convergence of independent phylogenies". The evidence given above demonstrates that for many ubiquitous functional proteins (such as cytochrome *c*), there is an enormous number of equivalent sequences which could form that protein in any given organism. Whenever we find that two organisms have the same or very similar sequences for a ubiquitous protein,

we know that something fishy is going on. Why would these two organisms have such similar ubiquitous proteins when the odds are astronomically against it? We know of only one reason for why two organisms would have two similar protein sequences in the absence of functional necessity: heredity. Thus, in such cases we can confidently deduce that the two organisms are genealogically related. In this sense, sequence similarity is not only a test of the theory of common descent; common descent is also a *deduction* from the principle of heredity and the observation of sequence similarity. Finally, the similarity observed for cytochrome *c* is not confined to this single ubiquitous protein; *all* ubiquitous proteins that have been compared between chimpanzees and humans are highly similar, and there have been many comparisons.

### Potential Falsification:

Without assuming the theory common descent, the most probable result is that the cytochrome *c* protein sequences in all these different organisms would be very different from each other. If this were the case, a phylogenetic analysis would be impossible, and this would provide very strong evidence for a genealogically unrelated, perhaps simultaneous, origin of species ([Dickerson 1972](#); [Yockey 1992](#); [Li 1997](#)).

Furthermore, the very basis of this argument could be undermined easily if it could be demonstrated (1) that species specific cytochrome *c* proteins were functional exclusively in their respective organisms, or (2) that no other cytochrome *c* sequence could function in an organism other than its own native cytochrome *c*, or (3) that an observed mechanism besides heredity can causally correlate the sequence of a ubiquitous protein with a specific organismic morphology.

### Prediction 4.2: DNA coding redundancy

Like protein sequence similarity, the DNA sequence similarity of two ubiquitous genes also implies common ancestry. Of course, comprehensive DNA sequence comparisons of conserved proteins such as cytochrome *c* also indirectly take into account amino acid sequences, since the DNA sequence specifies the protein sequence. However, with DNA sequences there is an extra level of redundancy. The genetic code itself is informationally redundant; on average there are three different codons (a codon is a triplet of DNA bases) that can specify the exact same amino acid ([Voet and Voet 1995](#), p. 966). Thus, for cytochrome *c* there are approximately  $3^{104}$ , or over  $10^{46}$ , different DNA sequences (and, hence,  $10^{46}$  different possible genes) that can specify the exact same protein sequence.

Here we can be quite specific in our prediction. Any sequence differences between two functional cytochrome *c* genes are necessarily functionally neutral or nearly so. The background mutation rate in humans (and most other mammals) has been measured at  $\sim 1.5 \times 10^{-8}$  base substitutions per site per generation ([Mohrenweiser 1994](#), pp. 128-129),

and an average primate generation is about 20 years. From the fossil record, we know that humans and chimpanzees diverged from a common ancestor less than 10 million years ago (a conservative estimate - most likely less than 6 million years ago) ([Stewart and Disotell 1998](#)). Thus, if chimps and humans are truly genealogically related, we predict that the difference between their respective cytochrome *c* gene DNA sequences should be less than 3% - probably even much less, due to the essential function of the cytochrome *c* gene.

### Confirmation:

As mentioned above, the cytochrome *c* proteins in chimps and humans are exactly identical. The clincher is that the two DNA sequences that code for [cytochrome \*c\* in humans and chimps differ by only four nucleotides](#) (a 1.2% difference), even though there are  $10^{49}$  different sequences that could code for this protein.

The combined effects of DNA coding redundancy and protein sequence redundancy make DNA sequence comparisons doubly redundant; DNA sequences of ubiquitous proteins are completely uncorrelated with phenotypic differences between species, but they are strongly causally correlated with heredity. This is why DNA sequence phylogenies are considered so robust.

### Potential Falsification:

The most probable result is that the DNA sequences coding for these proteins should be radically different. This would be a resounding falsification of macroevolution, and it would be very strong evidence that chimpanzees and humans are not closely genealogically related. Of course, the potential falsifications for [prediction 4.1](#) also apply to DNA sequences.

## Prediction 4.3: Molecular evidence - Transposons

In many ways, transposons are very similar to viruses. However, they lack genes for viral coat proteins, cannot cross cellular boundaries, and thus they replicate only in the genome of their host. They can be thought of as intragenomic parasites. Except in the rarest of circumstances, the only mode of transmission from one metazoan organism to another is directly by DNA duplication and inheritance (e.g. your transposons are given to your children) ([Li 1997](#), pp. 338-345).

Replication for a transposon means copying itself and inserting the copied DNA randomly somewhere else in the host's genome. Transposon replication (also called transposition) has been directly observed in many organisms, including yeast, corn, wallabies, humans,



bacteria, and flies, and recently the mechanisms have become well understood ([Li 1997](#), pp. 335-338; [Futuyma 1998](#), pp. 639-641). Specific observed cases of retrotransposition are known to have caused neurofibromatosis and hemophilia in humans ([Kazazian et al. 1988](#); [Wallace et al. 1991](#)), and cancer, among other diseases ([Deininger and Batzer 1999](#)).

This section on transposons, and the next two sections covering pseudogenes and endogenous retroviruses, are all related conceptually. The DNA sequences in intergenic regions (regions between protein-coding genes in genomes), include very many transposons (like LINEs and SINEs), endogenous retroviruses (like HERVs), pseudogenes, and other related sequences like microsatellites. Many microsatellites are closely associated with and generated by retrotransposons like LINEs and SINEs ([Arcot et al. 1995](#); [Nadir et al. 1996](#); [Wilder and Hollocher 2001](#); [Yandava et al. 1997](#)). These intergenic sequences are primarily responsible for the very specific patterns seen in "DNA fingerprinting" analyses, like those performed in paternity testing or sibling testing. Like fingerprints, these intergenic regions vary considerably between individual organisms and the patterns are largely arbitrary. For instance, Alu elements, one type of SINE retrotransposon, transpose into a new genomic location about every 200 human births ([Deininger and Batzer 1999](#)), and Alus contribute to a significant fraction of human genetic diversity ([Batzer and Deininger 2002](#)). In the case of the human L1 transposon, only one of many human LINE elements, a novel retrotransposition is harbored by around 1 in 20 individuals ([Scaringe et al. 2001](#); [Ostertag and Kazazian 2001](#)). This is a conservative estimate, given that each of us has around 50 retrotranspositional competent L1 LINEs ([Brouha et al. 2003](#)). Intergenic regions of the genome, like all DNA, is heritable and there is a very strong correlation between relatives. When two individuals are found that share specific intergenic patterns far above that expected by chance alone, it is very strong evidence of common ancestry. This is in fact the very scientific basis behind DNA fingerprinting.

As explained above, finding the same transposon in the same chromosomal location in two different organisms is strong direct evidence of common ancestry, since they insert fairly randomly and generally cannot be transmitted except by inheritance. In addition, once a common ancestor has been postulated that contains a certain transposition, all the descendants of this common ancestor should also contain the same transposition. A possible exception is if this transposition were removed due to a rare deletion event; however, deletions are never clean and usually part of the transposon sequence remains. Using the same principles behind DNA fingerprinting, biologists have used transposons, pseudogenes, and endogenous retroviruses to demonstrate that many species are genetically related, such as humans and other primates. A few of many examples are given below.

**Confirmation:**

A common class of transposon is the SINE retroelement ([Li 1997](#), pp. 349-352). One important SINE transposon is the 300 bp Alu element. All mammals contain many Alu elements, including humans where they constitute 10% of the human genome (i.e. 60 million bases of repetitive DNA) ([Smit 1996](#); [Li 1997](#), pp. 354, 357). Very recent human Alu transpositions have been used to elucidate historic and prehistoric human migrations, since some individuals have newer Alu insertions that other individuals lack ([Novick \*et al.\* 1993](#); [Novick \*et al.\* 1995](#)). In fact, common Alu transpositions have been demonstrated to be reliable markers of common descent in paternity cases and in criminal forensics ([Novick \*et al.\* 1993](#); [Novick \*et al.\* 1995](#); [Roy-Engel \*et al.\* 2001](#)). Most importantly, in the human  $\alpha$ -globin cluster there are seven Alu elements, and each one is shared with chimpanzees in the exact same seven locations ([Sawada \*et al.\* 1985](#)).

More specifically, three different specific SINE transpositions have been found in the same chromosomal locations of cetaceans (whales), hippos, and ruminants, all of which are closely related according to the standard phylogenetic tree. However, all other mammals, including camels and pigs, lack these three specific transpositions ([Shimamura 1997](#)).

More detail and explanation can be found on this topic in Edward Max's [Plagiarized Errors and Molecular Genetics FAQ](#).

### Potential Falsification:

See the two below, as the same principles apply here.

## Prediction 4.4: Molecular evidence - Redundant pseudogenes

Other molecular examples that provide evidence of common ancestry are curious DNA sequences known as pseudogenes. Pseudogenes are very closely related to functional, protein-coding genes. The similarity involves both the primary DNA sequence and often the specific chromosomal location of the genes. The functional counterparts of pseudogenes are normal genes that are transcribed into mRNA, which is in turn actively translated into functional protein. In contrast, pseudogenes have faulty regulatory sequences that prevent the gene from being transcribed into mRNA, or they have internal stop codons that keep the functional protein from being made. In this sense, pseudogenes are molecular examples of [vestigial structures](#).

However, pseudogenes are included here under a separate prediction because many pseudogenes are unusual in an additional way. Morphological vestiges have lost their original function, and the organism carrying the vestige has likewise lost that function. In

contrast, pseudogenes have lost their original function, yet the organism itself may still retain that function if it carries the functional counterpart of these pseudogenes. Pseudogenes that are vestigial in the morphological sense, like the vitamin C synthesis pseudogene, are considered in [prediction 2.3](#). The remaining type of pseudogene, in which an organism carries both a functional gene and one or more counterpart pseudogenes, is hereafter termed a "redundant pseudogene".

Most pseudogenes are largely non-functional. There are several lines of evidence that support this conclusion. First, the presence or absence of most specific pseudogenes has no measurable effect on organismal phenotype. Second, there are good mechanistic, genetic arguments indicating pseudogenes have little, if any, function. Pseudogenes have complex sequences highly similar or identical to those required for the proper function of other enzymatic or structural proteins. These normal genes are actively transcribed and translated into proteins, whereas pseudogenes are untranslated, untranscribed, or both. Thus, pseudogenes cannot perform the functions of the proteins they encode. If pseudogenes do have a function, they must perform relatively simple functions for which the protein encoded by them was not designed.

Third, if a pseudogene has little or no function, then most mutations in the pseudogene will have only minor functional consequences, and many mutations will not be weeded out by purifying selection. Therefore, we expect that truly non-functional pseudogenes should accumulate mutations at the background rate of mutation. Pseudogenes with minor functions will accumulate mutations near the background rate. As expected if pseudogenes have little, if any, function, most pseudogenes accumulate mutations at the fastest rate known for any region of DNA in animal genomes. Furthermore, the rate of mutation inferred for pseudogenes from phylogenetic analysis matches very closely the measured rates of spontaneous mutations. For more information and references, see [Prediction 5.8](#).

Fourth and finally, we understand how redundant pseudogenes are created, and we have observed the creation of new redundant pseudogenes in the lab and in the wild. Redundant pseudogenes originate by gene duplication and subsequent mutation. Many observed processes are known to duplicate genes, including transposition events, chromosomal duplication, and unequal crossing over of chromosomes.

These facts offer strong support for the conclusion that most pseudogenes have little, if any, function. Like transpositions (see [prediction 4.3](#)), the creation of new redundant pseudogenes by gene duplication is a rare and random event and, of course, any duplicated DNA is inherited. Thus, finding the same pseudogene in the same chromosomal location in two species is strong evidence of common ancestry.

**Confirmation:**

There are very many examples of redundant pseudogenes shared between primates and humans. One is the  $\psi\eta$ -globin gene, a hemoglobin pseudogene. It is shared among the primates only, in the exact chromosomal location, with the same mutations that destroy its function as a protein-coding gene ([Goodman et al. 1989](#)). Another example is the steroid 21-hydroxylase gene. Humans have two copies of the steroid 21-hydroxylase gene, a functional one and a untranslated pseudogene. Inactivation of the functional gene leads to congenital adrenal hyperplasia (CAH, a rare and serious genetic disease), giving positive evidence that the 21-hydroxylase pseudogene lacks its proper function. Both chimpanzees and humans share the same eight base-pair deletion in this pseudogene that renders it incapable of its normal function ([Kawaguchi et al. 1992](#)).

### Potential Falsification:

As explained above, observed gene duplications are rare and random events. Thus, it is highly unlikely that other mammals would have these same redundant pseudogenes in the same chromosomal locations, with the same mutations that cripple their normal functions. For instance, it is essentially impossible for mice to carry the 21-hydroxylase pseudogenes, in the same genomic location, with the same eight base-pair deletion that destroys its enzymatic function.

Furthermore, once a gene is duplicated and mutations render it a redundant pseudogene, it is inherited by all descendents. Thus, once certain organisms are found that carry the same pseudogene, common descent requires that all organisms phylogenetically intermediate must also carry that pseudogene. For example, suppose we find that humans and old world monkeys share a certain redundant pseudogene. According to common descent, all apes (including chimpanzees, gorillas, orangutans, and siamangs) must also necessarily carry that same redundant pseudogene in the same chromosomal location. This conclusion rests on the premise that there are no mechanisms for removing pseudogenes from genomes (or that the mechanisms are very inefficient). This apparently is true for vertebrates, but some organisms with short generation times, such as bacteria, protists, and *Drosophila* are known to have mechanisms that remove excess DNA.

Note, this confirmation and potential falsification are independent of whether a specific pseudogene has a function or whether it is completely non-functional, for the same reasons explained in the prediction on [morphological vestiges](#). Like any other genetic element or organismic structure, [evolutionary opportunism](#) may take a pseudogene and press it into a new and different function.

### Prediction 4.5: Molecular evidence - Endogenous retroviruses

Endogenous retroviruses provide yet another example of molecular sequence evidence for

universal common descent. Endogenous retroviruses are molecular remnants of a past parasitic viral infection. Occasionally, copies of a retrovirus genome are found in its host's genome, and these retroviral gene copies are called endogenous retroviral sequences. Retroviruses (like the AIDS virus or HTLV1, which causes a form of leukemia) make a DNA copy of their own viral genome and insert it into their host's

genome. If this happens to a germ line cell (i.e. the sperm or egg cells) the retroviral DNA will be inherited by descendants of the host. Again, this process is rare and fairly random, so finding retrogenes in identical chromosomal positions of two different species indicates common ancestry.

### Confirmation:

In humans, endogenous retroviruses occupy about 1% of the genome, in total constituting ~30,000 different retroviruses embedded in each person's genomic DNA ([Sverdlov 2000](#)). There are at least seven different known instances of common retrogene insertions between chimps and humans, and this number is sure to grow as both these organism's genomes are sequenced ([Bonner et al. 1982](#); [Dangel et al. 1995](#); [Svensson et al. 1995](#); [Kjellman et al. 1999](#); [Lebedev et al. 2000](#); [Sverdlov 2000](#)). [Figure 4.4.1](#) shows a phylogenetic tree of several primates, including humans, from a recent study which

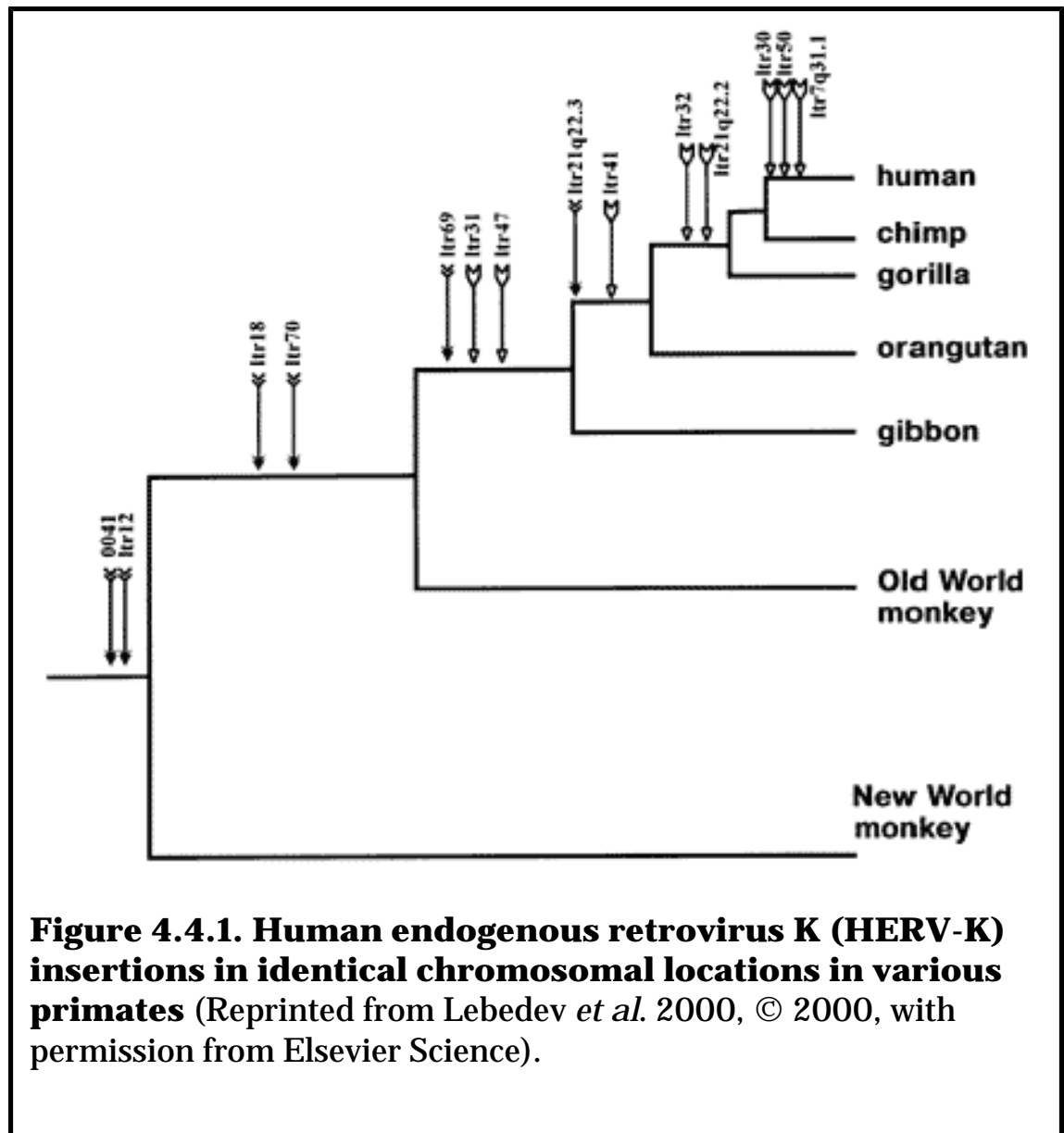

identified numerous shared endogenous retroviruses in the genomes of these primates ([Lebedev et al. 2000](#)). The arrows designate the relative insertion times of the viral DNA into the host genome. All branches after the insertion point (to the right) carry that retroviral DNA - a reflection of the fact that once a retrovirus has inserted into the germ-line DNA of a given organism, it will be inherited by all descendents of that organism.

The Felidae (i.e. cats) provide another example. The standard phylogenetic tree has small cats diverging later than large cats. The small cats (e.g. the jungle cat, European wildcat, African wildcat, blackfooted cat, and domestic cat) share a specific retroviral gene insertion. In contrast, all other carnivores which have been tested lack this retrogene ([Futuyma 1998](#), pp. 293-294; [Todaro et al. 1975](#)).

## Potential Falsification:

It would make no sense, macroevolutionarily, if certain other mammals (e.g. dogs, cows, platypi, etc.), had these same retrogenes in the exact same chromosomal locations. For instance, it would be incredibly unlikely for dogs to also carry the three HERV-K insertions that are unique to humans, as shown in the upper right of Figure 4.4.1, since none of the other primates have these retroviral sequences.



## References

Arcot, S.S., Wang, Z., Weber, J.L., Deininger, P.L., and Batzer, M.A. (1995) "Alu repeats: a source for the genesis of primate microsatellites." *Genomics*. 29: 136-144. [\[PubMed\]](#)

Batzer, M. A., and Deininger, P. L. (2002) "Alu repeats and human genomic diversity." *Nat Rev Genet*. 3: 370. [\[PubMed\]](#)

Bonner, T. I., C. O'Connell, *et al.* (1982) "Cloned endogenous retroviral sequences from human DNA." *PNAS* 79: 4709. [\[PubMed\]](#)

Branden, C. and Tooze, J. (1999) **Introduction to Protein Structure**. Second Ed., New York, Garland Publishing. [\[Publisher's Site\]](#)

Brouha, B., Schustak, J., Badge, R.M., Lutz-Prigge, S., Farley, A.H., Moran, J.V., Kazazian, H.H. (2003) "Hot L1s account for the bulk of retrotransposition in the human population." *Proc Natl Acad Sci U S A*. 100: 5280-5285. [\[PNAS free full text\]](#)

Bunn, H. F., and Forget, E. G. (1986) **Hemoglobin: Molecular, Genetic, and Clinical Aspects**. Saunders.

Clements, J. M., O'Connell, L. I., Tsunasawa, S., and Sherman, F. (1989) "Expression and activity of a gene encoding rat cytochrome *c* in the yeast *Saccharomyces cerevisiae*." *Gene* 83: 1-14. [\[PubMed\]](#)

Dangel, A. W., B. J. Baker, *et al.* (1995) "Complement component C4 gene intron 9 as a phylogenetic marker for primates: long terminal repeats of the endogenous retrovirus ERV-K(C4) are a molecular clock of evolution." *Immunogenetics* 42: 41-52. [\[PubMed\]](#)

Deininger, P. L., and Batzer, M. A. (1999) "Alu repeats and human disease." *Mol Genet Metab.* 67: 183-193. [\[PubMed\]](#)

Dickerson, R. E. (1972) *Scientific American*. 226: 58-72.

Dickerson, R. E., and Timkovich, R. (1975) **cytochrome c. The Enzymes**. P. D. Boyer. New York, Academic Press. 11: 397-547.

Futuyma, D. (1998) **Evolutionary Biology**. Third edition. Sunderland, MA, Sinauer Associates.

Goodman, M., B. F. Koop, *et al.* (1989) "Molecular phylogeny of the family of apes and humans." *Genome* 31 (316-335). [\[PubMed\]](#)

Hampsey, D. M., Das, G., and Sherman F. (1986) "Amino acid replacements in yeast iso-1-cytochrome *c*." *Journal of Biological Chemistry* 261: 3259-71. [\[PubMed\]](#)

Hampsey, D. M., Das, G., and Sherman F. (1988) "Yeast iso-1-cytochrome *c*: genetic analysis of structural requirements." *FEBS Letters* 231: 275-83. [\[PubMed\]](#)

Harris, J. I., F. Sanger, *et al.* (1956) "Species differences in insulin." *Archives of Biochemistry and Biophysics* 65: 427-438.

Hickey, D. R., Jayaraman, K., Goodhue, C. T., Shah, J., Fingar, S. A., Clements, J. M., Hosokawa, Y., Tsunasawa, S., and Sherman, F. (1991) "Synthesis and expression of genes encoding tuna, pigeon, and horse cytochromes *c* in the yeast *Saccharomyces cerevisiae*." *Gene* 105: 73-81. [\[PubMed\]](#)

Kawaguchi, H., C. O'hUigin, *et al.* (1992) "Evolutionary origin of mutations in the primate cytochrome P450c21 gene." *American Journal of Human Genetics* 50: 766-780. [\[PubMed\]](#)

Kazazian, H. H. (1999) "An estimated frequency of endogenous insertional mutations in humans." *Nat Genet.* 22: 130. [\[PubMed\]](#)

Kazazian, H. H., C. Wong, *et al.* (1988) "Haemophilia A resulting from de novo insertion of L1 sequences represents a novel mechanism for mutation in man." *Nature* 332: 164. [\[PubMed\]](#)

Kjellman, C., H. O. Sjogren, *et al.* (1999) "HERV-F, a new group of human endogenous retrovirus

sequences." *Journal of General Virology* 80: 2383. <http://vir.sgmjournals.org/cgi/content/full/80/9/2383>

Koshy, T. I., Luntz, T. L., Garber, E. A., and Margoliash, E. (1992) "Expression of recombinant cytochromes *c* from various species in *Saccharomyces cerevisiae*: post-translational modifications." *Protein Expr. Purif.* 3: 441-52. [\[PubMed\]](#)

Lebedev, Y. B., Belonovitch, O. S., Zybroya, N. V., Khil, P. P., Kurdyukov, S. G., Vinogradova, T. V., Hunsmann, G., and Sverdlov, E. D. (2000) "Differences in HERV-K LTR insertions in orthologous loci of humans and great apes." *Gene* 247: 265-277. [\[PubMed\]](#)

Lesk, Arthur M. (2001) **Introduction to Protein Architecture**. Oxford, Oxford University Press. [\[Publisher's Site\]](#)

Li, W.-H. (1997) **Molecular Evolution**. Sunderland, MA, Sinauer Associates.

Matthews, B. W. (1996) "Structural and genetic analysis of the folding and function of T4 lysozyme." *FASEB J.* 10: 35-41. [\[PubMed\]](#)

McLaughlin, P. J., and Dayhoff, M. O. (1973) "Eukaryote evolution: a view based on cytochrome *c* sequence data." *Journal of Molecular Evolution* 2(99-116).

Mohrenweiser, H. (1994) "Impact of the molecular spectrum of mutational lesions on estimates of germinal gene-mutation rates." *Mutation Research* 304: 119-137. [\[PubMed\]](#)

Moore, G. R., and Pettigrew, G. W. (1990) **Cytochromes c: Evolutionary, Structural and Physicochemical Aspects**. Berlin, Springer-Verlag.

Nadir, E., Margalit, H., Gallily, T., and Ben-Sasson, S. A. (1996) "Microsatellite spreading in the human genome: evolutionary mechanisms and structural implications." *Proc Natl Acad Sci U S A.* 93: 6470-6475. [\[PubMed\]](#)

Novick, G. E., Gonzalez, T., Garrison, J., Novick, C. C., Batzer, M. A., Deininger, P. L., Herrera, R. J. (1993) "The use of polymorphic Alu insertions in human DNA fingerprinting." *EXS.* 67: 283-291. [\[PubMed\]](#)

Novick, G. E., Novick, C. C., Yunis, J., Yunis, E., Martinez, K., Duncan, G. G., Troup, G. M., Deininger, P. L., Stoneking, M., Batzer, M. A., *et al.* (1995) "Polymorphic human specific Alu insertions as markers for human identification." *Electrophoresis* 16: 1596-1601. [\[PubMed\]](#)

Ostertag, E. M., and Kazazian, H. H. (2001) "Biology of mammalian L1 retrotransposons." *Annu Rev Genet.* 35: 501-538. [\[PubMed\]](#)

Ptitsyn, O. B. (1998) "Protein folding and protein evolution: common folding nucleus in different subfamilies of *c*-type cytochromes." *Journal of Molecular Biology* 278: 655. [\[PubMed\]](#)

Roy-Engel, A. M., Carroll, M. L., Vogel, E., Garber, R. K., Nguyen, S. V., Salem, A. H., Batzer, M. A., and Deininger, P. L. (2001) "Alu insertion polymorphisms for the study of human genomic diversity." *Genetics*



159: 279-290. <http://www.genetics.org/cgi/content/full/159/1/279>

Sawada, I., C. Willard, *et al.* (1985) "Evolution of Alu family repeats since the divergence of human and chimpanzee." *Journal of Molecular Evolution* 22(316). [\[PubMed\]](#)

Li, X., Scaringe, W. A., Hill, K. A., Roberts, S., Mengos, A., Careri, D., Pinto, M. T., Kasper, C. K., and Sommer, S. S. (2001) "Frequency of recent retrotransposition events in the human factor IX gene." *Hum Mutat.* 17: 511-519. [\[PubMed\]](#)

Scarpulla, R. C., and Nye, S. H. (1986) "Functional expression of rat cytochrome *c* in *Saccharomyces cerevisiae*." *Proc Natl Acad Sci* 83: 6352-6. [\[PubMed\]](#)

Shimamura, M., *et al.* (1997) "Molecular evidence from retroposons that whales form a clade within even-toed ungulates." *Nature* 388: 666. [\[PubMed\]](#)

Smit, A. F. A. (1996) "The origin of interspersed repeats in the human genome." *Current Opinion in Genetics and Development* 6: 743-748. [\[PubMed\]](#)

Stewart, C. B. and Disotell, T. R. (1998) "Primate evolution - in and out of Africa." *Current Biology* 8: R582-588. [\[PubMed\]](#)

Svensson, A. C., N. Setterblad, *et al.* (1995) "Primate DRB genes from the DR3 and DR8 haplotypes contain ERV9 LTR elements at identical positions." *Immunogenetics* 41: 74. [\[PubMed\]](#)

Sverdlov, E. D. (2000) "Retroviruses and primate evolution." *BioEssays* 22: 161-171. [\[PubMed\]](#)

Tanaka, Y., Ashikari, T., Shibano, Y., Amachi, T., Yoshizumi, H., and Matsubara, H. (1988a) "Amino acid replacement studies of human cytochrome *c* by a complementation system using CYC1 deficient yeast." *J Biochem (Tokyo) Sep*;104: 477-80. [\[PubMed\]](#)

Tanaka, Y., Ashikari, T., Shibano, Y., Amachi, T., Yoshizumi, H., and Matsubara, H. (1988b) "Construction of a human cytochrome *c* gene and its functional expression in *Saccharomyces cerevisiae*." *J Biochem (Tokyo)* 103: 954-61. [\[PubMed\]](#)

Todaro, G.J., Benveniste, R.E., Callahan, R., Lieber, M.M., and Sherr, C.J. (1975) "Endogenous primate and feline type C viruses." *Cold Spring Harb Symp Quant Biol.* 39 Pt 2:1159-1168. [\[PubMed\]](#)

Voet, D., and Voet, J. (1995) **Biochemistry**. New York, John Wiley and Sons.

Wallace, C. J., and Tanaka, Y. (1994) "Improving cytochrome *c* function by protein engineering?: studies of site-directed mutants of the human protein." *J. Biochem. (Tokyo)* 115: 693-700. [\[PubMed\]](#)

Wallace, M. R., L. B. Andersen, *et al.* (1991) "A *de novo* Alu insertion results in neurofibromatosis type 1." *Nature* 353: 864-866. [\[PubMed\]](#)

Wilder, J., and Hollocher, H. (2001) "Mobile elements and the genesis of microsatellites in dipterans." *Mol Biol Evol.* 18: 384-392. [\[PubMed\]](#)

Yandava, C. N., Gastier, J. M., Pulido, J. C., Brody, T., Sheffield, V., Murray, J., Buetow, K., and Duyk, G. M. (1997) "Characterization of Alu repeats that are associated with trinucleotide and tetranucleotide repeat microsatellites." *Genome Res.* 7: 716-724.

Yockey, H. P. (1992) **Information Theory and Molecular Biology**. New York, Cambridge University Press.

[Full references](#)

[Glossary](#)

 - 
  - 
  -  
[Previous](#)   [Contents](#)   [Next](#)

Home	Browse	Search	Feedback	Links
The FAQ		Must-Read Files		Index
Evolution		Creationism		Age of the Earth
Flood Geology		Catastrophism		Debates

[Home Page](#) | [Browse](#) | [Search](#) | [Feedback](#) | [Links](#)

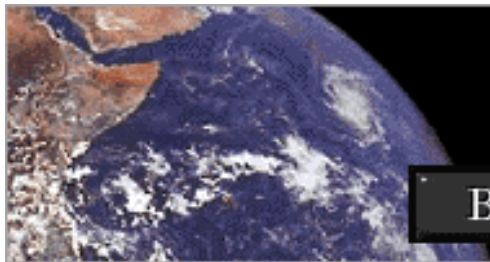

[The FAQ](#) | [Must-Read Files](#) | [Index](#) | [Creationism](#) | [Evolution](#) | [Age of the Earth](#) | [Flood Geology](#) | [Catastrophism](#) | [Debates](#)

[Browse](#)[Search](#)[Feedback](#)[Links](#)

## 29+ Evidences for Macroevolution

### Part 5: Change and Mutability

Copyright © 1999-2004 by [Douglas Theobald, Ph.D.](#)

---

[←](#) - [↑](#) - [→](#)  
[Previous](#)   [Contents](#)   [Next](#)

"What man that sees the ever-whirling wheel  
Of Change, the which all mortal things doth  
sway,  
But that therby doth find, and plainly feel,  
How Mutability in them doth play"

Edmund Spenser  
Folio 41v , c. AD 1200  
*The Faerie Queene*, bk. VII, ch. VI, 1596

#### Part 5 Outline

1. [Genetic change](#)
2. [Morphological change](#)
3. [Functional change](#)
4. [The strange past](#)
5. [Stages of speciation](#)
6. [Speciation events](#)
7. [Morphological rates](#)

## 8. [Genetic rates](#)

### Prediction 5.1: Genetic change

**T**he genetic information specifies everything about an organism and its potential. Genotype specifies possible phenotypes, therefore, phenotypic change follows genetic change. This obviously should be one of the areas where evolutionary change is seen, and genetic change is truly the most important for understanding evolutionary processes.

#### Confirmation:

Extremely extensive genetic change has been observed, both in the lab and in the wild. We have seen genomes irreversibly and heritably altered by numerous phenomena, including gene flow, random genetic drift, natural selection, and mutation. Observed mutations have occurred by mobile introns, gene duplications, recombination, transpositions, retroviral insertions (horizontal gene transfer), base substitutions, base deletions, base insertions, and chromosomal rearrangements. Chromosomal rearrangements include genome duplication (e.g. polyploidy), unequal crossing over, inversions, translocations, fissions, fusions, chromosome duplications and chromosome deletions ([Futuyma 1998](#), pp. 267-271, 283-294).

#### Potential Falsification:

Once the genetic material was elucidated, it was obvious that for macroevolution to proceed vast amounts of change was necessary in the genetic material. If the general observation of geneticists was that of genomic stasis and recalcitrance to significant genetic change, it would be weighty evidence against the probability of macroevolution. For instance, it is possible that whenever we introduce mutations into an organism's genome, the DNA could back-mutate to its former state. However, the opposite is the case; the genome is incredibly plastic, and genetic change is heritable and essentially irreversible ([Lewin 1999](#)).

### Prediction 5.2: Morphological change

Cladistic classification, and thus, phylogenetic reconstruction, is largely based on the various distinguishing morphological characteristics of species. Macroevolution requires that organisms' morphologies have changed throughout evolutionary history; thus, we should observe morphological change and variation in modern populations.

#### Confirmation:

There have been numerous observations of morphological change in populations of organisms ([Endler 1986](#)). Examples are the change in color of some organ, such as the yellow body or brown eyes of *Drosophila*, coat color in mice ([Barsh 1996](#)), scale color in fish ([Houde 1988](#)), and plumage pattern in birds ([Morton 1990](#)). Almost every imaginable heritable variation in size, length, width, or number of some physical aspect of animals has been recorded ([Johnston and Selander 1973](#); [Futuyma 1998](#), p. 247-262). This last fact is extremely important for common descent, since the major morphological differences between many species (e.g. species of amphibians, reptiles, mammals, and birds) are simple alterations in size of certain aspects of their respective [parahomologous](#) structures.

### Prediction 5.3: Functional change

One of the major differences between organisms is their capacity for various functions. The ability to occupy one niche over another is invariably due to differing functions. Thus, functional change must be extremely important for macroscopic macroevolutionary change.

#### Confirmation:

Many organisms have been observed to acquire various new functions which they did not have previously ([Endler 1986](#)). Bacteria have acquired resistance to viruses ([Luria and Delbruck 1943](#)) and to antibiotics ([Lederberg and Lederberg 1952](#)). Bacteria have also evolved the ability to synthesize new amino acids and DNA bases ([Futuyma 1998](#), p. 274). Unicellular organisms have evolved the ability to use nylon and pentachlorophenol (which are both unnatural manmade chemicals) as their sole carbon sources ([Okada et al. 1983](#); [Orser and Lange 1994](#)). The acquisition of this latter ability entailed the evolution of an entirely novel multienzyme metabolic pathway ([Lee et al. 1998](#)). Bacteria have evolved to grow at previously unviable temperatures ([Bennett et al. 1992](#)). In *E. coli*, we have seen the evolution (by artificial selection) of an entirely novel metabolic system including the ability to metabolize a new carbon source, the regulation of this ability by new regulatory genes, and the evolution of the ability to transport this new carbon source across the cell membrane ([Hall 1982](#)).

Such evolutionary acquisition of new function is also common in metazoans. We have observed insects become resistant to insecticides ([Ffrench-Constant et al. 2000](#)), animals and plants acquire disease resistance ([Carpenter and O'Brien 1995](#); [Richter and Ronald 2000](#)), crustaceans evolve new defenses to predators ([Hairston 1990](#)), amphibians evolve tolerance to habitat acidification ([Andren et al. 1989](#)), and mammals acquire immunity to poisons ([Bishop 1981](#)). Recent beneficial mutations are also known in humans, such as the

famous [apolipoprotein AI Milano mutation](#) that confers lowered risk to cardiovascular disease in its carriers.

## Prediction 5.4: Earth's strange past and the fossil record

A very general conclusion made from the theory of common descent is that life, as a whole, was different in the past. The predicted evolutionary pattern is that the farther back we look back in time, the more different life should appear from the modern biosphere. More recent fossils should be more similar to contemporary life forms than older fossils.

This point is related to, yet subtly different from, [prediction 1.4](#) and [prediction 1.5](#) concerning predicted common ancestors. As we have seen, the standard phylogenetic tree predicts many common ancestors and their morphologies. However, given what we know of modern species dynamics and recent extinction rates, we know that the majority of organisms will eventually go extinct ([Diamond 1984a](#); [Diamond 1984b](#); [Wilson 1992](#), ch. 12; [Futuyma 1998](#), pp. 722-723). By extrapolation, the majority of past organisms also have gone extinct. Thus, we should reasonably expect that the predicted common ancestors had many other descendants and relatives that did not leave descendants which survive today. In short, we predict that the majority of fossil species that we find should not be the actual common ancestors of modern species, but rather they should be related organisms that eventually ended in extinction.

### Confirmation:

The oldest rocks we find on the earth are about 4100 Mya, and they are devoid of any life. For the next 2000 million years, rocks from the Archean have no multicellular life at all, just prokaryotes. Then, 2100 Mya, appear the first fossils of eukaryotes (single-celled organisms with a nucleus). For another 1000 million years, there is still no evidence of multicellular life. The first hints of the existence of multicellular organisms comes from trace fossils of tiny worm burrows, found in sandstone dating at 1100 Mya.

Near the Precambrian/Cambrian transition, only 580 Mya, in the Ediacaran and Burgess shale faunas we finally find the first fossils of multicellular animals. However, they are very unusual, small, soft-bodied metazoans, and most are superficially unlike anything found today. Precisely as we would expect from the standard phylogenetic tree, the earliest fossils of multi-cellular life are very simple sponges and sea anemone-like organisms (sea anemones and jellyfish are both cnidarians). Around 20 million years later, we find the first evidence of simple mollusks, worms, and echinoderms (organisms similar to starfish and sea cucumbers). Another ~15 million years later, the very first vertebrates appear, though most people would strain to recognize them as such. They are small worm-like and primitive fish-like organisms, without bones, jaws, or fins (excepting

a single dorsal fin).

As we progress through the Phanerozoic, life gets progressively more similar to modern biota. In the Cambrian (~540 to 500 Mya), we find predominantly invertebrate sea organisms, such as trilobites, sponges, and echinoderms. During the next 100 million years sea life is dominated by invertebrates and strange jawless fish, which besides chordate worms are the only vertebrates around at the time. More familiar jawed fish only appear during the late Silurian, about 410 Mya. Ninety percent of the earth's sediments, up until the Devonian (~400 Mya), are devoid of any land animals.

During the Devonian, we finally find the first evidence of insects. For the next 100 million years, through the Carboniferous up until the Permian (~300 Mya), there are no land reptiles, no birds, nor mammals; only amphibians and insects. The land is covered by ferns; no pine trees or oaks or anything resembling them.

During the Mesozoic (from 250 to 65 Mya) life is dominated by monstrously large reptiles, the dinosaurs. The predominant plants are unusual gymnosperms, like the cycads. Nothing even resembling a modern mammal is found until the Jurassic, about 190 Mya. Even then, these "mammals" are small and appear half-reptile/half-rodent; far removed from the large megafauna yet to come. Ninety percent of the sediments on the earth which contain fossils of living organisms have no evidence of flowers; these appear for the first time just before the Paleocene (~65 Mya). Likewise, the earth's record of life is devoid of any hardwood forests until the beginning of the Cenozoic (~65 Mya to the present).

During the Cenozoic, mammals and birds finally come to prominence on the land, much as we find today. By the Pleistocene (2 Mya), the earth's biota closely, yet imperfectly, resembles what we presently find on the earth. Notable exceptions are the recent megafauna that covered the continents with organisms like mammoths, giant sloths, and saber-toothed tigers ([Futuyma 1998](#), pp. 130, 169-199).

### Potential Falsification:

This falsification would be simple and facile; the sediments of the earth could contain a composition of species very similar to modern life as far back as we can see in the sequential layers.

### Prediction 5.5: Stages of Speciation

The most useful definition of species (which does not assume evolution) for sexual metazoans is the Biological Species Concept: species are groups of actually or potentially interbreeding natural populations that are reproductively isolated from other such groups

([Mayr 1942](#)).

If branching of existing species into new species occurred gradually in the past, we should see all possible degrees of speciation or genetic isolation today, ranging from fully interbreeding populations, to partially interbreeding populations, to populations that interbreed with reduced fertility or with complete infertility, to completely genetically isolated populations.

### Confirmation:

There are countless cases of distinct species which can, in unusual or limited circumstances, form hybrids. One example is the West European carrion crow (*Corvus corone*) and the Asian hooded crow (*Corvus cornix*), which have distinct ranges meeting in a narrow "hybrid zone". Another are the Platte river species of sucker fish of the *Catostomus* genus which live together and only rarely interbreed ([Futuyma 1998](#), p. 454).

One of the most striking instances of partial or incomplete speciation are the numerous "ring species" (for review see [Irwin et al. 2001](#)). Ring species, such as the salamander *Ensatina*, form a chain of interbreeding populations which loop around some geographical feature; where the populations meet on the other side, they behave as completely different species. In the case of *Ensatina*, the subspecies form a ring around the Central Valley of California; the subspecies freely interbreed and hybridize on the east, west, and north sides of the valley, but where they coexist on the south side they are incapable of hybridizing and act as separate species ([Moritz et al. 1982](#); [Futuyma 1998](#), pp. 455-456).

Another example of a ring species is the gull genus *Larus*. *L. argentatus* and *L. fuscus* were originally identified as distinct species in England. However, there is a continuous ring of *Larus* hybrids extending to the east and west all the way round the North Pole. Only in England are they incapable of interbreeding.

The Great Tit, *Parus major*, similarly forms a ring species around the mountains of Central Asia, freely interbreeding everywhere except in Northern China ([Smith 1993](#), pp. 227-230).

Many species can hybridize, but the resulting offspring have reduced fertility. One example is the English shrew (genus *Sorex*) whose hybrids are reproductively disadvantaged due to chromosomal differences. This has also been seen in lab experiments mating Utah and California strains of *Drosophila pseudoobscura*. Another example are the frogs *Bombina bombina* and *Bombina variegata*, whose hybrids have low fitness (i.e. they do not reproduce very successfully) ([Barton and Gale 1993](#)).



Many other species can mate and produce viable hybrids, but the hybrids are infertile. This has been observed in species of amphibians (like certain frog species of the *Rana* genus) and mammals like *Equus* (where matings of horse and ass result in a sterile mule). Another example is the newt *Triturus cristatus* and *T. marmoratus*, in which hybrid infertility is due to unpaired chromosomes ([Smith 1993](#), pp. 253, 264).

Other species are able to mate with successful fertilization, but mortality occurs in embryogenesis. Such is the case with the frog species *Rana pipiens* and *R. sylvatica* ([Futuyma 1998](#), p. 460). This phenomenon has also been observed in *Drosophila*. Additional examples are also found in plants such as the cotton species *Gossypium hirsutum* and *G. barbadense* ([Smith 1993](#); [Futuyma 1998](#), ch. 15 and 16).

### Potential Falsification:

If all known species were completely genetically isolated from one another, and there were no instances of hybrids, it would be very difficult to reasonably justify the postulation of millions upon millions of gradual speciation events in the past.

### Prediction 5.6: Speciations

The [standard phylogenetic tree](#) illustrates countless speciation events; each common ancestor also represents at least one speciation event. Thus we should be able to observe actual speciation, if even only very rarely. Current estimates from the fossil record and measured mutational rates place the time required for full reproductive isolation in the wild at ~3 million years on average ([Futuyma 1998](#), p. 510). Consequently, observation of speciation in nature should be a possible but rare phenomenon. However, evolutionary rates in laboratory organisms can be much more rapid than rates inferred from the fossil record, so it is still possible that speciation may be observed in common lab organisms ([Gingerich 1983](#)).

### Confirmation:

Speciation of numerous plants, both angiosperms and ferns (such as hemp nettle, primrose, radish and cabbage, and various fern species) has been seen via hybridization and polyploidization since the early 20th century. Several speciation events in plants have been observed that did not involve hybridization or polyploidization (such as maize and *S. malheurensis*).

Some of the most studied organisms in all of genetics are the *Drosophila* species, which are commonly known as fruitflies. Many *Drosophila* speciation events have been extensively documented since the seventies. Speciation in *Drosophila* has occurred by spatial separation, by habitat specialization in the same location, by change in courtship

behavior, by disruptive natural selection, and by bottlenecking populations (founder-flush experiments), among other mechanisms.

Several speciation events have also been seen in laboratory populations of houseflies, gall former flies, apple maggot flies, flour beetles, *Nereis acuminata* (a worm), mosquitoes, and various other insects. Green algae and bacteria have been classified as speciated due to change from unicellularity to multicellularity and due to morphological changes from short rods to long rods, all the result of selection pressures.

Speciation has also been observed in mammals. Six instances of speciation in house mice on Madeira within the past 500 years have been the consequence of only geographic isolation, genetic drift, and chromosomal fusions. A single chromosomal fusion is [the sole major genomic difference between humans and chimps](#), and some of these Madeiran mice have survived nine fusions in the past 500 years ([Britton-Davidian et al. 2000](#)).

More detail and many references are given in the [Observed Instances of Speciation FAQ](#).

## Prediction 5.7: Morphological rates of change

Observed rates of evolutionary change in modern populations must be greater than or equal to rates observed in the fossil record.

### Confirmation:

Here I can do no better than to quote George C. Williams writing on this very issue:

"The question of evolutionary rate is indeed a serious theoretical challenge, but the reason is exactly opposite of that inspired by most people's intuitions. Organisms in general have not done nearly as much evolving as we should reasonably expect. Long-term rates of change, even in lineages of unusually rapid evolution, are almost always far slower than they theoretically could be." ([Williams 1992](#), p. 128)

In 1983, Phillip Gingerich published a famous study analyzing 512 different observed rates of evolution ([Gingerich 1983](#)). The study centered on rates observed from three classes of data: (1) lab experiments, (2) historical colonization events, and (3) the fossil record. A useful measure of evolutionary rate is the darwin, which is defined as a change in an organism's character by a factor of  $e$  per million years (where  $e$  is the base of natural log). The average rate observed in the fossil record was 0.6 darwins; the fastest rate was 32 darwins. The latter is the most important number for comparison; rates of evolution observed in modern populations should be equal to or greater than this rate.

The average rate of evolution observed in historical colonization events in the wild was 370 darwins; over 10 times the required minimum rate. In fact, the fastest rate found in colonization events was 80,000 darwins, or 2500 times the required rate. Observed rates of evolution in lab experiments are even more impressive, averaging 60,000 darwins and as high as 200,000 darwins (or over 6000 times the required rate).

A more recent paper evaluating the evolutionary rate in guppies in the wild found rates ranging from 4000 to 45,000 darwins ([Reznick 1997](#)). Note that a sustained rate of "only" 400 darwins is sufficient to transform a mouse into an elephant in a mere 10,000 years ([Gingerich 1983](#)).

One of the most extreme examples of rapid evolution was when the hominid cerebellum doubled in size within ~100,000 years during the Pleistocene ([Rightmire 1985](#)). This "unique and staggering" acceleration in evolutionary rate was only 7 darwins ([Williams 1992](#), p. 132). This rate converts to a minuscule 0.02% increase per generation, at most. For comparison, the fastest rate observed in the fossil record in the Gingerich study was 37 darwins over one thousand years, and this corresponds to, at most, a 0.06% change per generation.

### Potential Falsification:

If modern observed rates of evolution were unable to account for the rates found in the fossil record, the theory of common descent would be extremely difficult to justify, to put it mildly. For example, *Equus* evolutionary rates during the late Cenozoic could be consistently found to be greater than 80,000 darwins. Given the observed rates in modern populations, a rate that high would be impossible to explain. Since the average rate of evolution in colonization events is ~400 darwins, even an average rate of 4000 darwins in the fossil record would constitute a robust falsification.

### Prediction 5.8: Genetic rates of change

Rates of genetic change, as measured by nucleotide substitutions, must also be consistent with the rate required from the time allowed in the fossil record and the sequence differences observed between species.

### Confirmation:

What we must compare are the data from three independent sources: (1) fossil record estimates of the time of divergence of species, (2) nucleotide differences between species, and (3) the observed rates of mutation in modern species. The overall conclusion is that these three are entirely consistent with one another.

For example, consider the human/chimp divergence, one of the most well-studied evolutionary relationships. Chimpanzees and humans are thought to have diverged, or shared a common ancestor, about 6 Mya, based on the fossil record ([Stewart and Disotell 1998](#)). The genomes of chimpanzees and humans are very similar; their DNA sequences overall are 98% identical ([King and Wilson 1975](#); [Sverdlov 2000](#)). The greatest differences between these genomes are found in pseudogenes, non-translated sequences, and fourfold degenerate third-base codon positions. All of these are very free from selection constraints, since changes in them have virtually no functional or phenotypic effect, and thus most mutational changes are incorporated and retained in their sequences. For these reasons, they should represent the background rate of spontaneous mutation in the genome. These regions with the highest sequence dissimilarity are what should be compared between species, since they will provide an upper limit on the rate of evolutionary change.

Given a divergence date of 6 Mya, the maximum inferred rate of nucleotide substitution in the most divergent regions of DNA in humans and chimps is  $\sim 1.3 \times 10^{-9}$  base substitutions per site per year. Given a generation time of 15-20 years, this is equivalent to a substitution rate of  $\sim 2 \times 10^{-8}$  per site per generation ([Crowe 1993](#); [Futuyma 1998](#), p. 273).

Background spontaneous mutation rates are extremely important for cancer research, and they have been studied extensively in humans. A review of the spontaneous mutation rate observed in several genes in humans has found an average background mutation rate of  $1-5 \times 10^{-8}$  base substitutions per site per generation. This rate is a very minimum, because its value does not include insertions, deletions, or other base substitution mutations that can destroy the function of these genes ([Giannelli et al. 1999](#); [Mohrenweiser 1994](#), pp. 128-129). Thus, the fit amongst these three independent sources of data is extremely impressive.

Similar results have been found for many other species ([Kumar and Subramanian 2002](#); [Li 1997](#), pp. 180-181, 191). In short, the observed genetic rates of mutation closely match inferred rates based on paleological divergence times and genetic genomic differences. Therefore, the observed rates of mutation can easily account for the genetic differences observed between species as different as mice, chimpanzees, and humans.

### Potential Falsification:

It is entirely plausible that measured genetic mutation rates from observations of modern organisms could be orders of magnitude less than that required by rates inferred from the fossil record and sequence divergence.



[Previous](#)

[Contents](#)

[Next](#)

## References

Andren, C., M. Marden, *et al.* (1989) "Tolerance to low pH in a population of moor frogs, *Rana arvalis* from an acid and a neutral environment : a possible test case of rapid evolutionary response to acidification." *Oikos* 56: 215-223.

Barsh, G. S. (1996) "The genetics of pigmentation: from fancy genes to complex traits." *Trends in Genetics* 12: 299-305. [\[PubMed\]](#)

Barton, N. H., and Gale, R. S. (1993) "Genetic analysis of hybrid zones." In **Hybrid Zones and the Evolutionary Process**. New York, Oxford University Press: 12-45.

Bennett, A. F., R. E. Lenski, *et al.* (1992) "Evolutionary adaptation to temperature. I. Fitness responses of *Escherichia coli* to changes in its thermal environment." *Evolution* 46: 16-30.

Bishop, J. A. (1981) "A neo-Darwinian approach to resistance: Examples from mammals." In **Genetic Consequences of Man Made Change**. J. A. Bishop and L. M. Cook. London, Academic Press.

Britton-Davidian, J., J. Catalan, *et al.* (2000) "Rapid chromosomal evolution in island mice." *Nature* 403: 158. [\[PubMed\]](#)

Carpenter, M. A. and O'Brien, S. J. (1995) "Coadaptation and immunodeficiency virus: lessons from the Felidae." *Current Opinion in Genetics and Development* 5: 739-745. [\[PubMed\]](#)

Crowe, J. F. (1993) "Mutation, fitness, and genetic load." *Oxford Survey of Evolutionary Biology* 9: 3-42.

Diamond, J. M. (1984a) "Historic extinctions: A Rosetta Stone for understanding pre-historic extinctions." In **Quaternary Extinctions: A Prehistoric Revolution**. Eds. P. S. Martin and R. G. Klein. Tucson, University of Arizona Press: 824-862.

Diamond, J. M. (1984b) "Normal" extinctions of isolated populations. *Extinctions*. M. Nitecki. Chicago, University of Chicago Press: 191-246.

Endler, J. A. (1986) **Natural Selection in the Wild**. Princeton, NJ, Princeton University Press.

Ffrench-Constant, R. H., N. Anthony, *et al.* (2000) "Cyclodiene insecticide resistance: from molecular to population genetics." *Annual Review of Entymology* 45: 449-466. [\[PubMed\]](#)

Futuyma, D. (1998) **Evolutionary Biology**. Third edition. Sunderland, MA, Sinauer Associates.

- Giannelli, F., Anagnostopoulos, T., and Green, P. M. (1999) "Mutation rates in humans. II. Sporadic mutation-specific rates and rate of detrimental human mutations inferred from hemophilia B." *Am J Hum Genet* 65: 1580-1587. [\[PubMed\]](#)
- Gingerich, P. D. (1983) "Rates of evolution: Effects of time and temporal scaling." *Science* 222: 159-161.
- Hairston, N. G. (1990) "Fluctuating selection and response in a population of freshwater copepods." *Evolution* 44: 1796-1805.
- Hall, B. G. (1982) "Evolution on a petri dish: The evolved  $\beta$ -galactosidase system as a model for studying acquisitive evolution in the laboratory." *Evolutionary Biology* 15: 85-150.
- Houde, A. E. (1988) "Genetic differences in female choice between two guppy populations." *Animal Behavior* 36: 510-516.
- Irwin, D.E., Irwin, J.H., and Price, T.D. (2001) "Ring species as bridges between microevolution and speciation." *Genetica*. 112-113: 223-243. [\[PubMed\]](#)
- Johnston, R. F., and Selander, R. K. (1973) "Evolution in the house sparrow. III. Variation in size and sexual dimorphism in Europe and North and South America." *American Naturalist* 107: 373-390.
- King, M. C., and Wilson, A. C. (1975) "Evolution at two levels in humans and chimpanzees." *Science* 188: 107-116.
- Kumar, S., and Subramanian, S. (2002) "Mutation rates in mammalian genomes." *Proc Natl Acad Sci* 99: 803-808. <http://www.pnas.org/cgi/content/full/99/2/803>
- Lederberg, J., and Lederberg, E. M. (1952) "Replica plating and indirect selection of bacterial mutants." *Journal of Bacteriology* 63: 399-406.
- Lee, S. G., B. D. Yoon, *et al.* (1998) "Isolation of a novel pentachlorophenol-degrading bacterium, *Pseudomonas* sp. Bu34." *Journal of Applied Microbiology* 85: 1-8. [\[PubMed\]](#)
- Lewin, B. (1999) **Genes VII**. New York, Oxford University Press.
- Li, W.-H. (1997) **Molecular Evolution**. Sunderland, MA, Sinauer Associates.
- Luria, S., and Delbruck, M. (1943) "Mutations of bacteria from virus sensitivity to virus resistance." *Genetics* 28: 491-511.
- Mayr, E. (1942) **Systematics and the Origin of Species**. New York, Columbia University Press.
- Mohrenweiser, H. (1994) "Impact of the molecular spectrum of mutational lesions on estimates of germinal gene-mutation rates." *Mutation Research* 304: 119-137. [\[PubMed\]](#)
- Moritz, C., C. J. Schneider, *et al.* (1982) "Evolutionary relationships within the *Ensatina eschsoltzii* complex confirm the ring species interpretation." *Systematic Biology* 41: 273-291.

Morton, E. S. (1990) "Habitat segregation by sex in the hooded warbler: Experiments on proximate causation and discussion of its evolution." *American Naturalist* 135: 319-333.

Okada, H., S. Negoro, *et al.* (1983) "Evolutionary adaptation of plasmid-encoded enzymes for degrading nylon oligomers." *Nature* 306: 203-206. [\[PubMed\]](#)

Orser, C. S., and Lange, C. C. (1994) "Molecular analysis of pentachlorophenol degradation." *Biodegradation* 5: 277-288. [\[PubMed\]](#)

Reznick, D. N. (1997) "Evaluation of the rate of evolution in natural populations of guppies (*Poecilia reticulata*)." *Science* 275: 1934-1937. [\[PubMed\]](#)

Richter, T. E., and Ronald, P. C. (2000) "The evolution of disease resistance genes." *Plant Molecular Biology* 42: 195-204. [\[PubMed\]](#)

Rightmire, G. P. (1985) "The tempo of change in the evolution of mid- Pleistocene Homo." In **Ancestors: the Hard Evidence**. E. Delson. New York, Alan R. Liss: pp. 255-264.

Smith, J. M. (1993) **The Theory of Evolution**. Cambridge, Cambridge University Press.

Stewart, C. B., and Disotell, T. R. (1998) "Primate evolution—;in and out of Africa." *Current Biology* 8: R582-588. [\[PubMed\]](#)

Sverdlov, E. D. (2000) "Retroviruses and primate evolution." *BioEssays* 22: 161-171. [\[PubMed\]](#)

Williams, G. C. (1992) **Natural Selection: Domains, Levels, and Challenges**. New York, Oxford University Press.

Wilson, E. O. (1992) **The Diversity of Life**. Cambridge, MA, Harvard University Press.

[Full references](#)

[Glossary](#)

  
[Previous](#)   [Contents](#)   [Next](#)

Home	Browse	Search	Feedback	Links
The FAQ		Must-Read Files		Index
Evolution		Creationism		Age of the Earth
Flood Geology		Catastrophism		Debates

[Home Page](#) | [Browse](#) | [Search](#) | [Feedback](#) | [Links](#)



[The FAQ](#) | [Must-Read Files](#) | [Index](#) | [Creationism](#) | [Evolution](#) | [Age of the Earth](#) | [Flood Geology](#) | [Catastrophism](#) | [Debates](#)



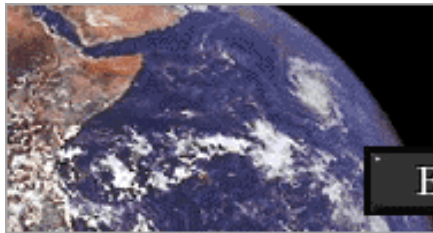

## 29+ Evidences for Macroevolution

### Part 4: Molecular Sequence Evidence

Copyright © 1999-2003 by [Douglas Theobald, Ph.D.](#)

  
[Back](#)

[Cytochrome c gene coding sequence for Pan troglodytes](#)  
[Cytochrome c gene coding sequence for Homo sapiens](#)

CLUSTAL W (1.83) multiple sequence alignment

```

human_cytc      ATGGGTGATGTTGAGAAAGGCAAGAAGATTTTTATTATGAAGTGTTCCAGTGCCACACC
chimp_cytc      ATGGGTGATGTTGAGAAAGGCAAGAAGATTTTTATTATGAAGTGTTCCAGTGCCATACC
*****

human_cytc      GTTGAAAAGGGAGGCAAGCACAAAGACTGGGCCAAATCTCCATGGTCTCTTTGGGCGGAAG
chimp_cytc      GTTGAAAAGGGAGGCAAGCACAAAGACTGGGCCAAATCTCCATGGTCTCTTCGGGCGGAAG
*****

human_cytc      ACAGGTCAGGCCCTGGATACTCTTACACAGCCGCAATAAGAACAAAGGCATCATCTGG
chimp_cytc      ACAGGTCAGGCCCTGGATATTCTTACACAGCCGCAATAAGAACAAAGGCATCATCTGG
*****

human_cytc      GGAGAGGATACTGATGGAGTATTTGGAGAATCCCAAGAAGTACATCCCTGGAACAAA
chimp_cytc      GGAGAGGATACTGATGGAGTATTTGGAGAATCCCAAGAAGTACATCCCTGGAACAAA
*****

human_cytc      ATGATCTTTGTCGGCATTAAAGAAGAAGGAAGAAAGGGCAGACTTAATAGCTTATCTCAA
chimp_cytc      ATGATATTTGTCGGCATTAAAGAAGAAGGAAGAAAGGGCAGACTTAATAGCTTATCTCAA
*****

human_cytc      AAAGCTACTAATGAGTAA
chimp_cytc      AAAGCTACTAATGAGTAA
    
```

\*\*\*\*\*



[Back](#)

<a href="#">Home</a>	<a href="#">Browse</a>	<a href="#">Search</a>	<a href="#">Feedback</a>	<a href="#">Links</a>
<a href="#">The FAQ</a>		<a href="#">Must-Read Files</a>		<a href="#">Index</a>
<a href="#">Evolution</a>		<a href="#">Creationism</a>		<a href="#">Age of the Earth</a>
<a href="#">Flood Geology</a>		<a href="#">Catastrophism</a>		<a href="#">Debates</a>

[Home Page](#) | [Browse](#) | [Search](#) | [Feedback](#) | [Links](#)



[The FAQ](#) | [Must-Read Files](#) | [Index](#) | [Creationism](#) | [Evolution](#) | [Age of the Earth](#) | [Flood Geology](#) | [Catastrophism](#) | [Debates](#)

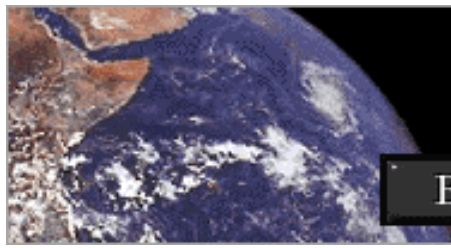

## 29+ Evidences for Macroevolution

### Some Statistics of Incongruent Phylogenetic Trees

Copyright © 1999-2004 by [Douglas Theobald, Ph.D.](#)

---



[Back](#)

#### Outline

- [Significance of incongruent trees](#)
- [P-value table](#)
- [P-value calculator](#)
- [Mathematical formulas](#)

**T**he table below and the javascript calculator following it provide values for the statistical significance of a match between two incongruent phylogenetic trees, reported as *P*-values. These *P*-values give the probability that two bifurcating rooted trees, with a given number (or less) of mismatching branches, would match by chance.

The number of incongruent branches is determined relative to the maximum agreement subtree (MAST) between two trees. A MAST is the "core" subtree that is common between two trees. The number of incongruent branches is equal to the minimum number of branches that must be pruned from one of the real trees to get the MAST. An example from John Harshman's analysis of crocodile species is given in the figure below ([Harshman et al. 2003](#)).



8	$7.4 \times 10^{-6}$	$5.2 \times 10^{-5}$	$6.8 \times 10^{-4}$	0.030	0.53	1.00	1.00	1.00				
9	$4.9 \times 10^{-7}$	$3.9 \times 10^{-6}$	$6.2 \times 10^{-5}$	0.0035	0.089	1.00	1.00	1.00	1.00			
10	$2.9 \times 10^{-8}$	$2.6 \times 10^{-7}$	$4.6 \times 10^{-6}$	$3.3 \times 10^{-4}$	0.012	0.22	1.00	1.00	1.00	1.00		
11	$1.5 \times 10^{-9}$	$1.5 \times 10^{-8}$	$3.0 \times 10^{-7}$	$2.7 \times 10^{-5}$	0.0012	0.032	0.49	1.00	1.00	1.00	1.00	
12	$7.2 \times 10^{-11}$	$8.0 \times 10^{-10}$	$1.8 \times 10^{-8}$	$1.9 \times 10^{-6}$	$1.1 \times 10^{-4}$	0.0037	0.076	0.98	1.00	1.00	1.00	1.00
13	$3.1 \times 10^{-12}$	$3.8 \times 10^{-11}$	$9.1 \times 10^{-10}$	$1.2 \times 10^{-7}$	$8.3 \times 10^{-6}$	$3.5 \times 10^{-4}$	0.0095	0.17	1.00	1.00	1.00	1.00
14	$1.2 \times 10^{-13}$	$1.6 \times 10^{-12}$	$4.3 \times 10^{-11}$	$6.6 \times 10^{-9}$	$5.6 \times 10^{-7}$	$2.9 \times 10^{-5}$	$9.9 \times 10^{-4}$	0.022	0.33	1.00	1.00	1.00
15	$4.6 \times 10^{-15}$	$6.6 \times 10^{-14}$	$1.8 \times 10^{-12}$	$3.3 \times 10^{-10}$	$3.3 \times 10^{-8}$	$2.1 \times 10^{-6}$	$8.7 \times 10^{-5}$	0.0025	0.048	0.62	1.00	1.00
16	$1.6 \times 10^{-16}$	$2.4 \times 10^{-15}$	$5.6 \times 10^{-14}$	$1.5 \times 10^{-11}$	$1.8 \times 10^{-9}$	$1.3 \times 10^{-7}$	$6.7 \times 10^{-6}$	$2.3 \times 10^{-4}$	0.0056	0.095	1.00	1.00
17	$5.2 \times 10^{-18}$	$8.3 \times 10^{-17}$	$2.1 \times 10^{-15}$	$6.4 \times 10^{-13}$	$8.6 \times 10^{-11}$	$7.5 \times 10^{-9}$	$4.5 \times 10^{-7}$	$1.9 \times 10^{-5}$	$5.6 \times 10^{-4}$	0.012	0.18	1.00
18	$1.5 \times 10^{-19}$	$2.7 \times 10^{-18}$	$7.4 \times 10^{-17}$	$2.5 \times 10^{-14}$	$3.8 \times 10^{-12}$	$3.9 \times 10^{-10}$	$2.7 \times 10^{-8}$	$1.4 \times 10^{-6}$	$4.9 \times 10^{-5}$	0.0013	0.024	0.32
19	$4.5 \times 10^{-21}$	$8.1 \times 10^{-20}$	$2.3 \times 10^{-18}$	$8.9 \times 10^{-16}$	$1.6 \times 10^{-13}$	$1.8 \times 10^{-11}$	$1.5 \times 10^{-9}$	$8.6 \times 10^{-8}$	$3.7 \times 10^{-6}$	$1.2 \times 10^{-4}$	0.0027	0.046
20	$1.2 \times 10^{-22}$	$2.3 \times 10^{-21}$	$7.3 \times 10^{-20}$	$3.0 \times 10^{-17}$	$5.9 \times 10^{-15}$	$7.8 \times 10^{-13}$	$7.3 \times 10^{-11}$	$4.9 \times 10^{-9}$	$2.5 \times 10^{-7}$	$9.2 \times 10^{-6}$	$2.5 \times 10^{-4}$	0.0054
<b>Number of taxa</b>	exact match	1 adjacent	1	2	3	4	5	6	7	8	9	10

### P-value Calculator

This calculator finds the upper bound on the probability that two or more trees would mismatch by a given number of branches or less by random. It is reliable for very large numbers, as it uses the logarithmic form of an improved Stirling's approximation for large factorials (for example, try 100,000 for number of taxa and 99,389 for number of incongruent branches).

rooted      unrooted  
**Number of Trees:**

**Number of Taxa:**

**Number of Incongruent Branches:**

**$P$ -value  $\leq$**

## Mathematical Details

For an exact match between two trees (no incongruence):

$$P = (2^{N-2})(N-2)! / (2N-3)!$$

or

$$P = 1 / (2N-3)!!$$

where "!!" is [double factorial](#) notation and  $N = \#$  of taxa. For an incongruency of "1 adjacent" branch:

$$P = (2^{N-2})(N-1)! / (2N-3)!$$

For an incongruency of  $I$  branches, misplaced anywhere between two trees:

$$P \leq (2^{N-I-2})(N-I-2)!N! / (2[N-I]-3)!(N-I)!I!$$

or

$$P \leq (N! / (N-I)!I!) / (2[N-I]-3)!!$$

where  $N = \#$  of taxa and  $I = \#$  of incongruent branches.

This last  $P$ -value calculation is an upper bound. That is, this  $P$ -value is an overestimation, since the actual  $P$ -value is very likely to be lower (better).  $P$  is the ratio of the maximum number of possible incongruent trees over the total number of possible trees. However, in the final equation the calculated maximum number of incongruent trees includes nonunique trees (i.e., some of the incongruent trees have the same topology and thus are counted more than once). For example, for  $N = 4$  and  $I = 1$ , this calculation gives  $P \leq 1.3333$ , while the exact  $P = 0.73333$ . At large  $N$  and  $I$ ,  $P$  converges on the exact value.

These equations can be extended easily to the case of discrepancies between more than two trees,

each of the same number of taxa. The probability that  $k$  rooted, binary,  $N$ -taxa trees have at most  $I$  incongruent branches is:

$$P \leq (N! / (N-I)! I!) / ((2[N-I]-3)!!)^{\{k-1\}}$$

Equivalently, this is the probability that two or more  $N$ -taxa trees will share the same MAST of size  $N - I$  or greater. The Javascript calculator above uses this equation to determine its  $P$ -values.

I would appreciate hearing from anyone who has any ideas on how to correct for nonunique trees. I independently derived most of these equations in the summer of 2002. Later I discovered via personal correspondence that Mike Steel had also derived these equations and was soon to publish all but the last in an upcoming book ([Bryant et al. 2002](#)). It appears that the final equation was independently derived by both me and Mike Steel, and to my knowledge it remains unpublished.

## References

Li, W.-H. (1997). **Molecular Evolution**. Sunderland, MA, Sinauer Associates. p. 102.

Bryant, D., MacKenzie, A. and Steel, M. (2002). "The size of a maximum agreement subtree for random binary trees." In: **Bioconsensus II**. DIMACS Series in Discrete Mathematics and Theoretical Computer Science (American Mathematical Society). ed., M.F. Janowitz.

Harshman, J., Huddleston, C. J., Bollback, J. P., Parsons, T. J., and Braun, M. J. (2003). "True and false gharials: a nuclear gene phylogeny of crocodylia." *Syst Biol.* 52: 386-402. [[PubMed](#)]

[Full references](#)

[Glossary](#)



[Back](#)

Home	Browse	Search	Feedback	Links
The FAQ	Must-Read Files		Index	
Evolution	Creationism		Age of the Earth	
Flood Geology	Catastrophism		Debates	

[Home Page](#) | [Browse](#) | [Search](#) | [Feedback](#) | [Links](#)



[The FAQ](#) | [Must-Read Files](#) | [Index](#) | [Creationism](#) | [Evolution](#) | [Age of the Earth](#) | [Flood Geology](#) | [Catastrophism](#) | [Debates](#)



## Charles Darwin on Classification and the Nested Hierarchy

From the beginning of Chapter 14 of *The Origin of Species*  
Section "Classification"

---



[Prediction](#)

[1.2](#)

**I** request the reader to turn to the diagram illustrating the action, as formerly explained, of these several principles; and he will see that the inevitable result is, that the modified descendants proceeding from one progenitor become broken up into groups subordinate to groups. In the diagram each letter on the uppermost line may represent a genus including several species; and the whole of the genera along this upper line form together one class, for all are descended from one ancient parent, and, consequently, have inherited something in common. But the three genera on the left hand have, on this same principle, much in common, and form a subfamily, distinct from that containing the next two genera on the right hand, which diverged from a common parent at the fifth stage of descent. These five genera have also much in common, though less than when grouped in subfamilies; and they form a family distinct from that containing the three genera still further to the right hand, which diverged at an earlier period. And all these genera, descended from (A), form an order distinct from the genera descended from (I). So that we here have many species descended from a single progenitor grouped into genera; and the genera into subfamilies, families and orders, all under one great class. The grand fact of the natural subordination of organic beings in groups under groups, which, from its familiarity, does not always sufficiently strike us, is in my judgment thus explained. No doubt organic beings, like all other objects, can be classed in many ways, either artificially by single characters, or more naturally by a number of characters. We



know, for instance, that minerals and the elemental substances can be thus arranged. In this case there is of course no relation to genealogical succession, and no cause can at present be assigned for their falling into groups. But with organic beings the case is different, and the view above given accords with their natural arrangement in group under group; and no other explanation has ever been attempted.

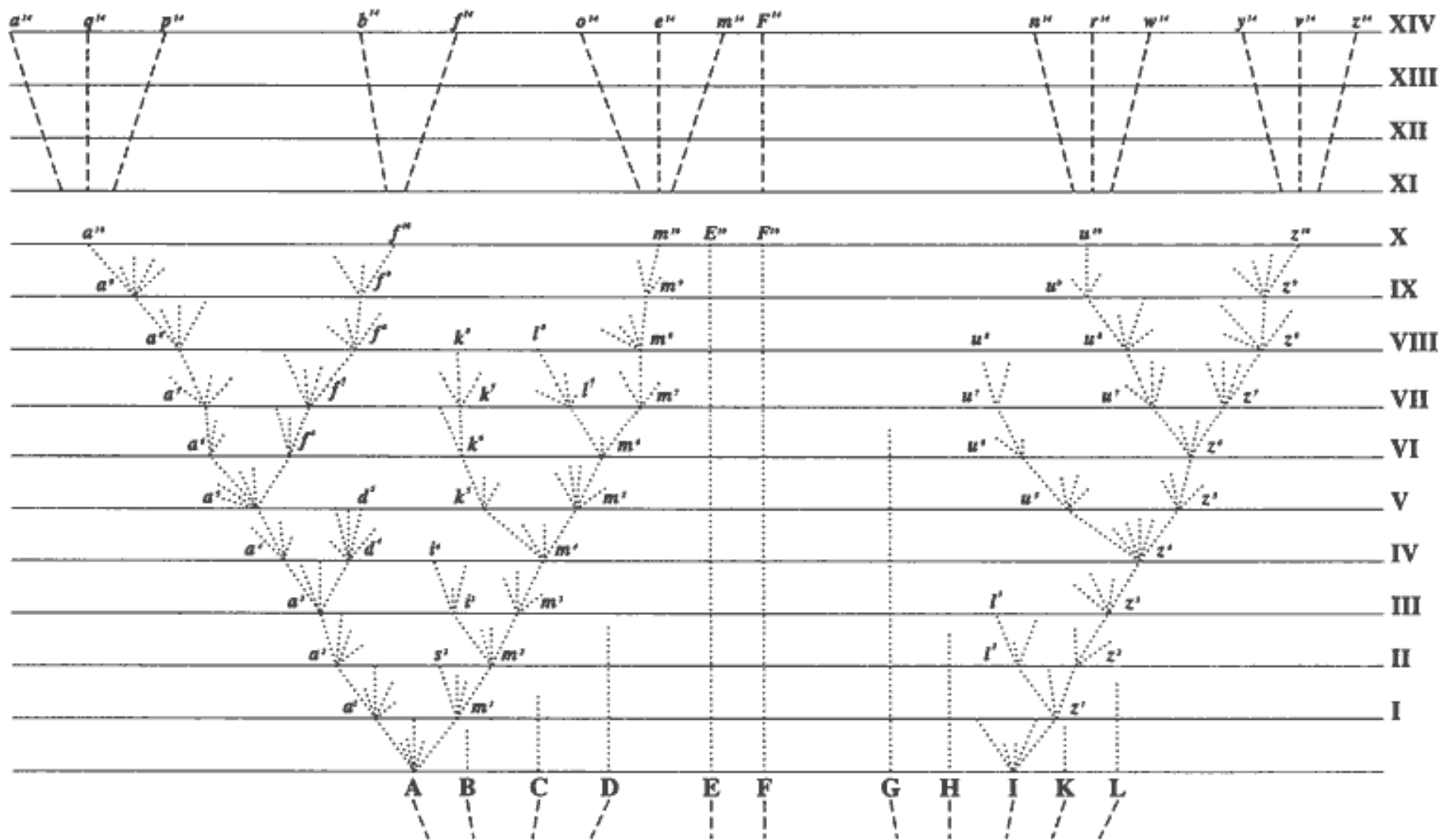

The only figure in *On the Origin of Species*

Click here for a [larger version of this image \(60K GIF file\)](#).

Darwin, C. (1872), pp. 149, 551-552. **The Origin of Species**. Sixth Edition. The Modern Library, New York.



[Prediction](#)

[1.2](#)

Home	Browse	Search	Feedback	Links
The FAQ	Must-Read Files	Index		
Evolution	Creationism	Age of the Earth		
Flood Geology	Catastrophism	Debates		

[Home Page](#) | [Browse](#) | [Search](#) | [Feedback](#) | [Links](#)

[The FAQ](#) | [Must-Read Files](#) | [Index](#) | [Creationism](#) | [Evolution](#) | [Age of the Earth](#) | [Flood Geology](#) | [Catastrophism](#) | [Debates](#)

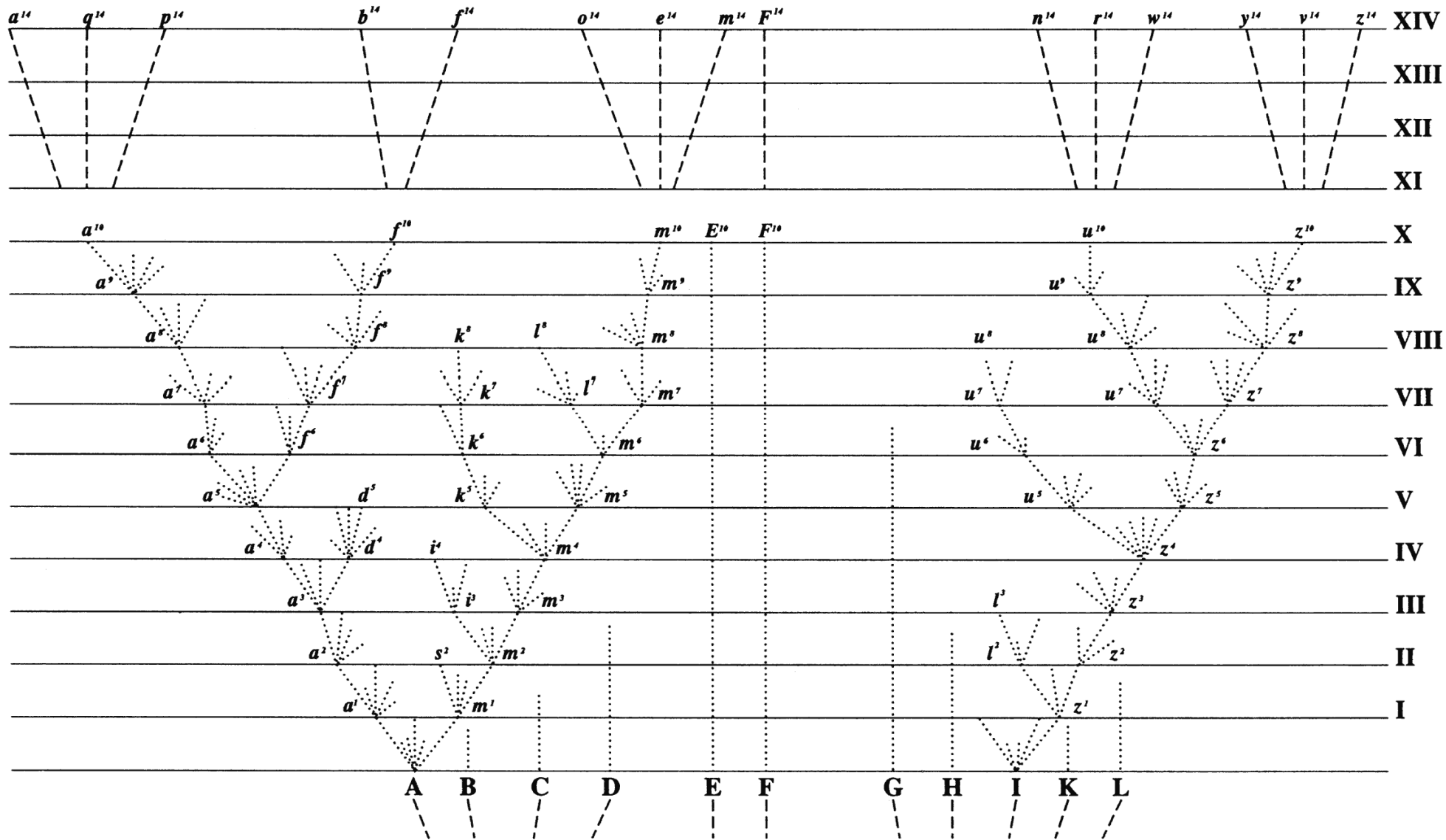



## 29+ Evidences for Macroevolution

### Closing remarks

Copyright © 1999-2003 by [Douglas Theobald, Ph.D.](#)

---

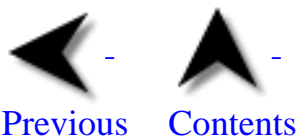

**T**hese previous points are all evidence of macroevolution alone; the evidence and the conclusion are independent of any specific gradualistic explanatory mechanisms for the origin and evolution of macroevolutionary adaptations. This is why scientists call universal common descent the "fact of evolution". As explained in the introduction, none of the predictions directly address *how* macroevolution has occurred; nevertheless, the validity of the macroevolutionary conclusion does not depend on whether Darwinism, Lamarckism (i.e. inheritance of acquired characters), or something else is the true mechanism of adaptive evolutionary change. The macroevolutionary conclusion stands, regardless.

This point has an interesting parallel in physics. Newton's theory of universal gravitation describes a phenomenon of matter, just as macroevolution describes a phenomenon of life. The theory of universal gravitation is also independent of the specific explanatory mechanism for gravity, and in fact Newton never gave a mechanism for gravity. Why does the force between two masses follow the inverse square law and not another law (perhaps an inverse cube law)? It took nearly 300 years before [any plausible mechanisms for gravity](#) were proposed (by quantum field theorists). None of these proposed mechanisms currently have any experimental support. Additionally, theories of gravity are strictly dependent upon the concept of mass, and there currently is no empirically supported [mechanism for giving mass to matter](#). Charles Darwin is considered such a great scientific mind because, unlike Newton and Einstein who proposed only descriptive theories, Darwin proposed both a descriptive theory and a plausible mechanism. That mechanism is, of course, heritable variation with natural selection.

## Acknowledgements

Mike Hopkins has generously donated his expertise and time to provide off-site links to the references cited in this FAQ, for which I am extremely grateful. I also wish to thank Brett Vickers, John Wilkins, Wesley Elsberry, Edward Max, Jim Foley, Laurence Moran, Ashby Camp, Cornelius George Hunter, Richard Harter, Matt Silberstein, Neil Rickert, Larry Handlin, John Harshman, Paul Gans, Sarah Clark, Paul Danaher, Howard Hershey, maff, Adam Noel Harris, Rich Daniel, Wade Hines, Chris Nedin, Peter Nyikos, Gavin Tabor, Andrew McRae, Ken Cox, Ken Cope, Mike Goodrich, Norm Pace, Scott Classen, Tom Schneider, Steve Schultz, Carl Woese, and Catherine Theobald (and others I am surely, yet unintentionally omitting) for their helpful comments, corrections, suggestions, discussion, and criticism. All remaining errors are mine and mine alone.

[Full references](#)

[Glossary](#)



  
[Previous](#)   [Contents](#)

Home	Browse	Search	Feedback	Links
The FAQ		Must-Read Files		Index
Evolution		Creationism		Age of the Earth
Flood Geology		Catastrophism		Debates

[Home Page](#) | [Browse](#) | [Search](#) | [Feedback](#) | [Links](#)



[The FAQ](#) | [Must-Read Files](#) | [Index](#) | [Creationism](#) | [Evolution](#) | [Age of the Earth](#) | [Flood Geology](#) | [Catastrophism](#) | [Debates](#)

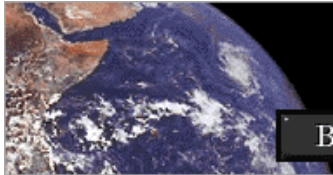

Browse

Search

Feedback

Links

## 29 Evidences for Macroevolution

### Part 1: The Unique Universal Phylogenetic Tree

Copyright © 1999-2002 by [Douglas Theobald, Ph.D.](#)

  
[Back](#)

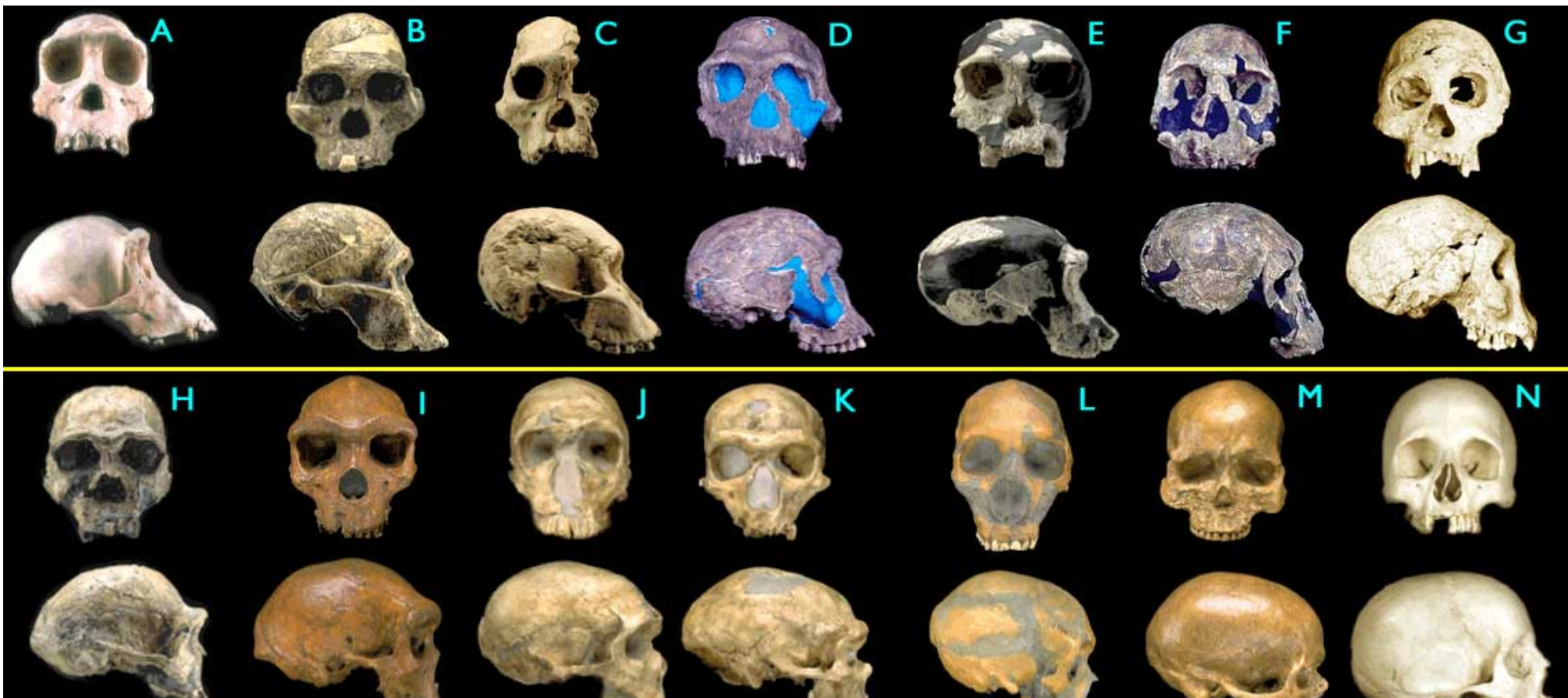



**Figure 1.4.4.** Fossil hominid skulls. Some of the figures have been modified for ease of comparison (only left-right mirroring or removal of a jawbone). (Images © 2000 [Smithsonian Institution](#).)

- (A) *Pan troglodytes*, chimpanzee, modern
- (B) [Australopithecus africanus, STS 5](#), 2.6 My
- (C) [Australopithecus africanus, STS 71](#), 2.5 My
- (D) *Homo habilis*, [KNM-ER 1813](#), 1.9 My
- (E) *Homo habilis*, [OH24](#), 1.8 My
- (F) *Homo rudolfensis*, [KNM-ER 1470](#), 1.8 My
- (G) *Homo erectus*, [Dmanisi cranium D2700](#), 1.75 My
- (H) *Homo ergaster* (early *H. erectus*), [KNM-ER 3733](#), 1.75 My
- (I) *Homo heidelbergensis*, "[Rhodesia man](#)," 300,000 - 125,000 y
- (J) *Homo sapiens neanderthalensis*, [La Ferrassie 1](#), 70,000 y
- (K) *Homo sapiens neanderthalensis*, [La Chappelle-aux-Saints](#), 60,000 y
- (L) *Homo sapiens neanderthalensis*, [Le Moustier](#), 45,000 y
- (M) *Homo sapiens sapiens*, [Cro-Magnon I](#), 30,000 y
- (N) *Homo sapiens sapiens*, modern

▲  
[Back](#)

Home	Browse	Search	Feedback	Links
The FAQ		Must-Read Files		Index
Evolution		Creationism		Age of the Earth
Flood Geology		Catastrophism		Debates

[Home Page](#) | [Browse](#) | [Search](#) | [Feedback](#) | [Links](#)

[The FAQ](#) | [Must-Read Files](#) | [Index](#) | [Creationism](#) | [Evolution](#) | [Age of the Earth](#) | [Flood Geology](#) | [Catastrophism](#) | [Debates](#)

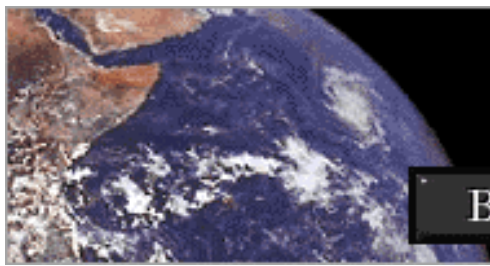

# The Talk.Origins Archive

Exploring the Creation/Evolution Controversy

[Browse](#)
[Search](#)
[Feedback](#)
[Links](#)

## Charles Darwin on Phylogeny and "Tree-thinking"

From Chapter 4 of **The Origin of Species**, Natural Selection.  
Section "Descendants of a Common Ancestor"



[Cladistics](#)

**I**t is a truly wonderful fact--the wonder of which we are apt to overlook from familiarity--that all animals and all plants throughout all time and space should be related to each other in groups, subordinate to groups, in the manner which we everywhere behold--namely, varieties of the same species most closely related, species of the same genus less closely and unequally related, forming sections and sub-genera, species of distinct genera much less closely related, and genera related in different degrees, forming sub-families, families, orders, sub-classes, and classes. The several subordinate groups in any class cannot be ranked in a single file, but seem clustered round points, and these round other points, and so on in almost endless cycles. If species had been independently created, no explanation would have been possible of this kind of classification; but it is explained through inheritance and the complex action of natural selection, entailing extinction and divergence of character, as we have seen illustrated in the [diagram](#).

The affinities of all the beings of the same class have sometimes been represented by a great tree. I believe this simile largely speaks the truth. The green and budding twigs may represent existing species; and those produced during former years may represent the long succession of extinct species. At each period of growth all the growing twigs have tried to branch out on all sides, and to overtop and kill the surrounding twigs and branches, in the same manner as species and groups of species have at all times overmastered other species in the great battle for life. The limbs divided into great branches, and these into lesser and lesser branches, were themselves once, when the tree



was young, budding twigs; and this connexion of the former and present buds by ramifying branches may well represent the classification of all extinct and living species in groups subordinate to groups. Of the many twigs which flourished when the tree was a mere bush, only two or three, now grown into great branches, yet survive and bear the other branches; so with the species which lived during long-past geological periods, very few have left living and modified descendants. From the first growth of the tree, many a limb and branch has decayed and dropped off; and these fallen branches of various sizes may represent those whole orders, families, and genera which have now no living representatives, and which are known to us only in a fossil state. As we here and there see a thin, straggling branch springing from a fork low down in a tree, and which by some chance has been favoured and is still alive on its summit, so we occasionally see an animal like the Ornithorhynchus or Lepidosiren, which in some small degree connects by its affinities two large branches of life, and which has apparently been saved from fatal competition by having inhabited a protected station. As buds give rise by growth to fresh buds, and these, if vigorous, branch out and overtop on all sides many a feebler branch, so by generation I believe it has been with the great Tree of Life, which fills with its dead and broken branches the crust of the earth, and covers the surface with its ever-branching and beautiful ramifications.

Darwin, C. (1872), pp. 170-171. **The Origin of Species**. Sixth Edition. The Modern Library, New York.



[Cladistics](#)

Home	Browse	Search	Feedback	Links
The FAQ		Must-Read Files		Index
Evolution		Creationism		Age of the Earth
Flood Geology		Catastrophism		Debates

[Home Page](#) | [Browse](#) | [Search](#) | [Feedback](#) | [Links](#)  
[The FAQ](#) | [Must-Read Files](#) | [Index](#) | [Creationism](#) | [Evolution](#) | [Age of the Earth](#) | [Flood Geology](#) | [Catastrophism](#) | [Debates](#)



## 29+ Evidences for Macroevolution

### A Response to Ashby Camp's "Critique"

Copyright © 1999-2003 by [Douglas Theobald, Ph.D.](#)

[Updated on March 21, 2002]



**A**nti-evolutionist Ashby Camp has penned a [critique](#) of these "[29 Evidences of Macroevolution](#)," which can be found posted at [TrueOrigin](#). Camp's critique is well-written, very thorough, and quite lengthy (the criticism is longer than the original article). Although I intend to address Camp's concerns in totality, currently I can only devote a limited amount of time to this effort. In the meantime, this partial response will suffice. I would like to thank Camp for his congenial criticism. It has given me the impetus to rework and expand the "29 Evidences," and the result is a more comprehensive, clearer, and stronger article.

My response has been two-fold. First, I have incorporated new material into the original essay that specifically addresses many of Camp's points, and thus much of his response is now superfluous. Second, in the following sections I rebut the more egregious errors found in Camp's criticism, especially ones that would interrupt the flow and thrust of the original article if they were included there. In the following response, Camp's words are indented in **grey boxes**, set apart from mine. Material that Camp has quoted in his criticism is also in the **grey boxes**, surrounded by quotes, and followed by the pertinent external reference.

Mr. Camp's critique is error-ridden in various ways, and is primarily characterized by:

1. Straw man arguments
2. Red herrings
3. Self-contradictions
4. Equivocation
5. Two wrongs make a right
6. Fallacies of accident and converse accident
7. Ignoratio elenchi
8. Naive theological assumptions
9. Insufficient knowledge of basic biology, molecular biology, biochemistry and genetics
10. Misunderstanding of the scientific method
11. Forwarding of untestable competing "hypotheses"
12. Mischaracterization of evolutionary theory

13. Misleading mis-quotes
14. Fallacies of accent
15. Distortion of scientific controversies
16. Arguments from authority
17. False analogies

The repeated use of these errors and others in Camp's "Critique" will be abundantly clear in the following rebuttal.

**Note:** Since the time I wrote this reply, Mr. Camp has responded to this in a shorter article entitled "[Camp answers Theobald](#)." The elements which I felt deserve some mention are included here enclosed in **green boxes**.

## Outline

- [Prediction 1: The fundamental unity of life](#)
- [Prediction 2: Nested hierarchy of species organization](#)
- [Prediction 3: Independent convergence on true phylogeny](#)
- [Prediction 4: Morphology of common ancestors](#)
- [Prediction 5: Chronology of common ancestors](#)
- [Conclusion](#)

## Prediction 1: The fundamental unity of life

### [A straw man](#)

Ashby Camp writes:

The alleged prediction and fulfillment are:

1. If universal common ancestry is true, then all organisms will have one or more traits in common.
2. All organisms have one or more traits in common.

Although Camp is most likely simply trying to paraphrase the point succinctly, he distorts the intent in doing so. The prediction is more specific than the above. To quote from the original [prediction 1](#):

"Some of the macroscopic properties that characterize all of life are (1) replication, (2) information flow in continuity of kind, (3) catalysis, and (4) energy utilization (metabolism) .... all living species today should necessarily have ... inherited the *structures* that perform these functions. The genealogical relatedness of all life predicts that organisms should be very *similar in the particular mechanisms and structures* that execute these basic life processes." (emphasis added)

Which traits should be in common was and is expressly stated—the structures and mechanisms that perform the four basic life functions.

Camp does not consider his paraphrase to be a [straw man](#):

... I do not see how my summary phrasing qualifies as a straw man, given that it encompasses the claim being made. If one argues that two bullets must have come from the same gun because they have certain striations in common, would it be a straw man to say the claim was that the two bullets must have come from the same gun because they have one or more traits in common? Specifying the traits (striations) does not affect the nature of the argument ...

"Encompassing" a claim is not stating the claim, just as the United States is not Colorado. Camp's gun-and-bullet example certainly is a straw man. We cannot infer that two bullets came from the same gun if they have just any two traits in common. For instance, two bullets might be both made of lead or they might both weigh the same. Can we thus infer that they both came from the same gun? No—that inference is only valid when it is based upon traits that are caused by a particular gun, such as specific striations. Rephrasing the argument as Camp does is a [straw man](#), since the rephrased argument is a weaker form of the real argument, and since the weaker form is much easier to criticize. Specifying the traits certainly does change the nature of the argument, because the valid inference is solely based upon *certain types* of traits (for bullets, those traits caused by a specific gun; for common descent, those traits strongly constrained by gradualism).

## Conflation of mechanism with gradualism

Camp writes:

Unless one inserts an additional premise imposing a limit on the degree to which descendants can vary (which would require specification of a mechanism of descent), the claim of common ancestry does not require that all of the descendants share one or more traits. There is no *logical* reason why completely novel organisms could not arise in one or more lineages. Absent specification of a mechanism of descent, which Dr. Theobald purposefully avoids, there is no way to tether the traits of the descendants to those of the common ancestor.

In fact, there *are* limits on the degree to which descendants can vary. The constraint of gradualism is inherent in the theory of universal common descent—a point made explicitly in the original article. To quote from the introduction:

"... macroevolution is proposed to occur on a geological timescale and in a gradual manner .... Gradualness concerns genetically probable organismic changes between two consecutive generations, i.e. those changes that are within the range of normal variation observed within modern populations."

Elsewhere in his criticism (e.g., [footnote 6](#)), Camp bemoans the article's indifference to mechanism in explaining the evidence for common descent. Throughout the article, it is assumed that the fundamentals of biology (such as genetics, molecular biology, and developmental biology) are correct, especially those not directly dealing with the origin and evolution of biological adaptations. In creation-evolution debates this is not especially controversial; nearly all anti-evolutionists, including those who believe in special creation, also make this assumption. Though gradualism is not formally a mechanism of evolution (like natural selection or Lamarckism could be), gradualism does indeed put severe constraints on possible macroevolutionary phenomena, and it also constrains any possible mechanisms. Thus, Camp is incorrect when he says:

... universal common ancestry is compatible with *all* mechanisms of common descent, including divine direction. So if God chose to have a reptile give birth to a bird, for example, that would be consistent with an "amechanistic" argument for universal common ancestry.

A modern reptile giving birth to a modern bird is not gradual; it is saltation, since such changes between two consecutive generations are not genetically probable—they are not "within the range of normal variation observed within modern populations." This is not to say that God could not have created species independently and miraculously, yet gradually. While there currently is absolutely no scientific evidence for such an idea, *gradual* Divine direction of evolution is indeed consistent and compatible with common descent. In [footnote 1](#), Camp paradoxically criticizes the constraint of gradualism:

In restricting the mechanism of macroevolution to observable degrees of genetic variation, Dr. Theobald lets in the back door the very debate about mechanism that he tossed out the front. He thereby assumes the burden of proving that accumulated observable variation can account for universal common ancestry. Since he makes no attempt to meet that burden but rather repeatedly disavows the relevance of any particular mechanism of modification, I assume he did not intend to specify accumulated observable variation as the mechanism of macroevolution, despite what his definitions may suggest.

As stated earlier, though gradualism is not a mechanism, it does indeed constrain possible explanatory mechanisms. Common descent is not concerned with exactly *how* adaptive change has happened, but *whether* it has happened and *whether it is consistent* with normal observed genealogical processes. Camp is wrong to say that the sufficiency of "accumulated observable variation" to account for universal common descent is left unaddressed. This requirement was and is explicitly considered in Part 5, "[Change and Mutability](#)," specifically in predictions [22](#), [23](#), [24](#), [28](#), and [29](#).<sup>6</sup>

## A Misunderstanding of Evolutionary Fundamentals

Camp continues with ReMine's words:

"Second, even if life originated precisely once, then evolutionary theory would still not predict biologic universals. Shortly after life's origin, nothing prevented life from branching and leading separate lineages to higher life forms entirely lacking the known biologic universals.

Third, evolutionary loss and replacement processes could prevent biologic universals. If one organism is a distant ancestor to another, then nothing in evolution predicts the two must share similarities. If evolution were true, then distant ancestors and descendants (as well as sister groups) can be totally different." ([ReMine 1993](#), p. 92-93)

Here Camp again dismisses the fundamentals of biology and the constraint of gradualism. Common descent *does* predict specific biological universals, since any significant change (any "loss and replacement processes") in the structures that perform the four basic life functions would result in nonviable organisms; these structures cannot be lost nor can they be replaced (although they can be expounded upon). Once life attained these specific structures (by whatever process), they were essentially frozen. Gradualism constrains life from "branching and leading separate lineages to higher life forms entirely lacking the known biologic universals." Of course "distant ancestors and descendants ... can be totally different"—

totally different *except* in the structures that perform the four fundamental functions of life.

Common descent does not predict that these structures must be identical, just that the similarity must be statistically significant, and that there must be viable intermediates between the variations. For instance, because the genetic code is degenerate, common descent does not predict an *identical* genetic code in all organisms. However, all known genetic codes are extremely similar, with an extremely high degree of statistical significance. In fact, common descent does not require that all organisms even have a genetic code. If life evolved from something that lacked a genetic code, then there must have been a series of organisms with transitional codes, beginning with no code at all. It is at least possible that such organisms could still be alive today. But if common descent is true, then the genetic codes of these organisms would be less complex versions of the modern genetic code and would retain statistically significant similarity to the modern universal genetic code. This is a testable prediction, in principle.

That said, the main important point of "prediction 1" is this—we can make very strong *a posteriori* predictions about biological universals by combining common descent with what is known. As a scientific analogy, Newton's Theory of Universal Gravitation does not predict planets, nor does it predict the present trajectories of planets. But given the known measured trajectory of an existing planet, we can use Newton's theory to predict what the trajectory will be in the future and what it must have been in the past, and these predictions can be confirmed or falsified. Likewise, given the fact that we now know that all organisms studied to date, including bacteria and birds, have a very similar genetic code, we can use common descent to predict that all undiscovered or unexamined organisms that fit between bacteria and birds in the standard phylogenetic tree will also have a similar genetic code. Because of common descent, we predict this even though this prediction is not functionally necessary—many other equivalent genetic codes could function equally well. Because of common descent, we know that certain types of organisms will be extremely similar in the biological universals before we actually go and check the organisms to see what their structures really look like. Thus, Hunter is incorrect when Camp quotes him saying:

"Consider how evolutionists would react if there were in fact multiple codes in nature. What if plants, animals, and bacteria all had different codes? Such a finding would not falsify evolution; rather, it would be incorporated into the theory ... " ([Hunter 2001](#), p. 38)

First, common descent *does* predict that the genetic codes should be similar *a priori*. Hunter is speculating about how biologists would have reacted in a hypothetical historical scenario in which we did not find highly similar codes between organisms. In reality, we can never know how biologists would have reacted to that, since that hypothetical scenario did not happen. What *is* known, however, is that the scientists who cracked the genetic code in the 1950's and 1960's worked under the assumption that the code was universal or nearly so ([Judson 1996](#), p. 280-281). These scientists, which included Francis Crick, Sydney Brenner, George Gamow, and several others, all made this assumption and justified it based upon evolutionary reasoning, even in the complete absence of any experimental evidence. In fact, this assumption was instrumental in their success in solving the code. For instance, in 1957, nearly ten years before the genetic code was finally solved, Sydney Brenner published an influential paper in which he concluded that all overlapping triplet codes were impossible if the code was universal ([Brenner 1957](#)). This paper was widely considered a landmark work, since many researchers were leaning towards an overlapping code. Of course, it turned out that Brenner was correct about the nature of the true code. In 1961, five years before the code was deciphered, Crick and others also concluded that the code was (1) a triplet code, (2) non-overlapping, and (3) that the code is read from a fixed starting point (i.e. the "start" codon) ([Crick et al. 1961](#)). These conclusions were explicitly based on the assumption that the code was essentially the same in tobacco, humans, and bacteria, though there was no empirical support for this assumption. These conclusions turned out to be correct. In fact, in 1963—*three years before the code was finally solved*—Hinegardner and Engelberg published a paper in *Science* specifically explaining why the code must be universal (or nearly

so) if universal common descent were true, since most mutations in the code would likely be lethal to all living things. Note, Hinegardner and Engelberg did allow for some variation in the genetic code, and predicted how such variation should be distributed if found:

"... if different codes do exist they should be associated with major taxonomic groups such as phyla or kingdoms that have their roots far in the past." ([Hinegardner and Engelberg 1963](#))

Their evolutionary prediction was correct, since the minor variations in the standard genetic code are indeed associated with major taxonomic groups (vertebrates vs. plants vs. single-celled ciliates, etc.).

Second, we now know from experimental research that many plants, many animals, and many bacteria all have extremely similar genetic codes. There is no known biological reason, aside from common descent, for why the genetic codes of different species should be similar. Any new discovery of a plant, animal, or bacteria with a radically different genetic code would be a highly unexpected result if common descent is true.

## The Logical Fallacy of [Equivocation](#)

Camp continues with Hunter's quote:

"There is nothing wrong with a theory that is comfortable with different outcomes, but there is something wrong when one of those outcomes is then claimed as supporting evidence. If a theory can predict both A and not-A, then neither A nor not-A can be used as evidence for the theory. When it comes to the genetic code, evolution can accommodate a range of findings, but it cannot then use one of those findings as supporting evidence." ([Hunter 2001](#), p. 38.)

Common descent does not predict "both A and not-A"—it predicts "both A and B." Hunter [equivocates](#) by misidentifying "A and not-A" with a *range* of predicted outcomes. A range of outcomes (i.e. "A and B") does not necessarily encompass *all* possible outcomes (i.e. "A and not-A")—thus the [equivocation](#). If a theory predicts both A and B, then either A or B *can* be used as evidence for the theory.

All scientific theories predict a range of outcomes. For example, Newtonian physics predicts that projectiles will follow elliptical paths, parabolic paths, or linear paths, contingent upon the relevant conditions. Newtonian physics thus predicts A, B, and C, and any of A, B, or C can be used as evidence for Newtonian physics. This point is important, since Camp uses this same argument again, incorrectly, in his conclusion. Hunter's claim that "there is something wrong when one of those [different] outcomes is then claimed as supporting evidence" is clearly false as a blanket statement about scientific theories. To rewrite Hunter's incorrect statement: when it comes to the genetic code, evolution predicts a range of findings, and it can use any of those findings as supporting evidence. That's how science works.

Camp further obfuscates the prediction of biological universals by introducing hypotheses concerning the origin of the universal ancestor. He writes:

The fact that some leading evolutionists believe early life forms were biochemically distinct from modern forms confirms that evolution does not predict biologic universals. Robert Shapiro, for example, entertains the possibility of finding living relics of an original protein-based life form that lacked DNA and RNA. (Shapiro, 293-295.) Likewise, A. G. Cairns-Smith thinks that descendants of ancient crystalline clay organisms may be all around us. He states: "Evolution did not start with the organic molecules that have now become universal to life: indeed I doubt whether the first organisms, even the first evolved organisms, had any organic molecules in them at all." (Cairns-Smith, 107.)

First, exactly how the universal ancestor originated and evolved is not within the realm of common descent; common descent concerns all evolution and descent from the *last* common ancestor to the present. Secondly, and most importantly, these speculative hypotheses have no influence upon certain predictions of universals, such as the genetic code. The genetic code is a mechanism to translate nucleic acid information (DNA and/or RNA) into protein. Shapiro's original life form lacked DNA and RNA—it did not have a genetic code. Cairns-Smith's crystalline clay organisms had neither protein nor nucleic acid—thus neither did they have a genetic code. The universality of the genetic code was proposed based upon two facts: all known life carries genetic information in nucleic acids, and all known life performs metabolic functions with proteins. All known life thus has a genetic code. If all known life is also united by common descent, it must also be united by a universal genetic code. As recounted above, this was the exact reasoning of Francis Crick, Sydney Brenner, George Gamow, and Marshall Nirenberg when they were cracking the genetic code. Camp, and other anti-evolutionists like ReMine, can carp and criticize—yet the fact remains that real biologists, doing hard science, made predictions and got phenomenal results based upon common descent and the deduction of biological universals.

### An Unscientific "Alternative": The [Fallacy of Untestability](#)

On the other hand, ReMine argues that biologic universals are a prediction of his message theory of creation, which "says all life was constructed to look like the unified work of a single designer." (ReMine, 94.) So evolution does not predict the unity of living things, but at least one theory of creation does. Of course, the biochemical similarity of living things fits easily within a creation framework.

Of course biochemical similarity fits easily in a "creation framework." Anything can fit in the creation framework. This is precisely why present anti-evolutionary creationist theories are unscientific; all possible results are consistent with the "hypothesis." If there were no biochemical similarity, would that be inconsistent with the "creation framework"? For example, if we found an insect that had a genetic code radically different from the standard genetic code, would that mean that Divine creation was impossible? No—creationists would not be scrambling to explain that result (but evolutionary biologists would be).

ReMine's "message" hypothesis is much too vague to be tested scientifically. What does a "unified work" look like? How would the biological world look if it were a "divided work"? Can ReMine quantify "appearance of unity"? Would independent researchers, perhaps from different cultures and countries, deduce the same predictions from this "message hypothesis"? Surely not—how something "looks" in terms of unity is subjective; it is not an objective property of life. How are we to distinguish between a single designer and multiple designers? Does Microsoft Word or an iMac or a Nissan Pathfinder look like the result of a single designer or multiple designers? A more fundamental problem is that ReMine's "message" hypothesis is not mutually exclusive with common descent, though he and Camp both seem to think that it is. Many world religions consider the existence of physical laws, such as the theory of universal gravitation, to be evidence that the universe is the unified work of a single Designer. In principle, couldn't a single designer have used evolution to make all of life look like a unified work? Of course; ReMine's conjecture



and common descent could both be true.

## Naive Theology and Poor Biochemistry

Camp continues his discussion of how well he believes that creationism can explain biochemical similarities by quoting this fine piece of "scientific" creationist reasoning from Duane Gish:

"A creationist would also expect many biochemical similarities in all living organisms. We all drink the same water, breathe the same air, and eat the same food. Supposing, on the other hand, God had made plants with a certain type of amino acids, sugars, purines, pyrimidines, etc.; then made animals with a different type of amino acids, sugars, purines, pyrimidines, etc.; and, finally, made man with a third type of amino acids, sugars, etc. What could we eat? We couldn't eat plants; we couldn't eat animals; all we could eat would be each other! Obviously, that wouldn't work. All the key molecules in plants, animals, and man had to be the same. The metabolism of plants, animals, and man, based on the same biochemical principles, had to be similar, and therefore key metabolic pathways would employ similar macromolecules, modified to fit the particular internal environment of the organism or cell in which it must function." (Gish, 277.)

Both Gish and Camp obviously feel that God is extremely limited in ingenuity. Gish's contention is ridiculous; why couldn't God have created plants with one certain type of amino acids and animals with another type, and simply given animals the enzymes that metabolize plant amino acids? Wouldn't that be clever design? Obviously, that *would* work, and all the key molecules in plants, animals, and man did not have to be the same. Now, this fact does not mean that God should have made things this way, but it certainly highlights the naive theological assumption made by Gish and Camp that God was incapable of creating things this way.

### Another straw man

Camp ends his criticism of Prediction 1 with this straw man:

The claim that all organisms have one or more traits in common is true in the sense that all living things necessarily have the traits by which life is defined, but that is simply a tautology—living things all have the traits of living things.

As at the beginning, Camp's paraphrase is incorrect. The above claim is not the prediction of biological universals; the prediction is that structures which perform the basic functions that characterize life should be similar. Living things have the functions of living things (a tautology), but because all things are related by heredity (i.e. common descent), living things also should have similar structures and mechanisms that perform these basic functions (a deduction from common descent). It is possible that living things could all have the basic functions that characterize life while also having very different, chemically and structurally unrelated mechanisms that perform these basic functions. The prediction of biological universals is, therefore, not tautologous. And, as a deduction of common descent, the prediction of biological universals is testable, confirmable, and falsifiable. Furthermore, this prediction has been confirmed and has not been falsified. Like any good scientific theory, the possibility exists that it may be falsified in the future by the acquisition of new data, though this is highly unlikely since all other evidence confirms the validity of common descent.

### Prediction 2: A nested hierarchy of species

## Misrepresentation of Evolutionary Theory and Erroneous Logic

Camp's argument is simply that descent by modification from a common ancestor does not predict a nested hierarchy. Camp is just plain incorrect here; all genealogical processes produce nested hierarchies. Think of your own family tree—your grandparents might have several kids, each of those kids (your aunts, uncles, and parents) have their own families, each of the children in those families (like you) may have their own children and even your children can have their own families. Each family is nested within another family, which in turn is nested within another family, and so on. Camp attempts to explain himself in his refusal to accept this basic concept:

Common descent can explain or accommodate nested hierarchy ... but it does not predict it. There are mechanisms of descent from a common ancestor that would yield a different pattern. If common descent can yield either nested hierarchy or something else, then the presence of nested hierarchy does not count as evidence of common descent.

Camp claims that different patterns can result from common descent, but he fails to provide any examples to support this odd claim. If Camp means that "randomness" is a pattern (stretching the term "pattern"), then, yes, under certain conditions common descent predicts that some characters of species will be random with respect to each other. However, as has been discussed already, all theories in science predict multiple outcomes contingent upon the relevant conditions. This is not a problem for any scientific theory. Camp's last statement above is transparently false; it is the same error discussed above in Hunter's "A and not-A" claim. Common descent can predict two different outcomes and it can still use either of those outcomes as supporting evidence.

## Another Misunderstanding of Evolutionary Theory

Camp has since [replied](#) to this criticism:

... the claim that the hypothesis of universal common ancestry makes a falsifiable prediction that organisms will exhibit a pattern of nested hierarchy is incorrect. Indeed, Dr. Theobald acknowledged in both prediction 2 and the response to my critique that Lamarck's organic progression would yield a non-nested pattern of organisms. ... since Lamarck's organic progression (to pick one example) admittedly does not predict a nested hierarchy, a nested hierarchy is not evidence of common descent via Lamarck's organic progression. Therefore, it is not evidence of common descent regardless of "whether Darwinism, Lamarckism, or something else is the true mechanism of evolutionary change," which is the proposition being argued by Dr. Theobald.

Although Camp still does not provide us with an example of a non-nested pattern generated by common descent, he does think that Lamarck's organic progression would predict a non-nested pattern. Camp is correct. However, Camp does not understand the difference between Lamarckism (or inheritance of acquired characters), which is an evolutionary mechanism, and the Lamarckian organic progression, which is not an evolutionary mechanism but is a descriptive macroevolutionary theory. *Of course* Lamarck's organic progression does not predict a nested hierarchy—it is mutually exclusive with common descent. Lamarck's organic progression is a competing theory, and common descent and the organic progression cannot both be true. However, Lamarckian evolution (by inheritance of acquired characters) could, in principle, be a mechanism of change that drives common descent by gradual modification. Camp's discussion here just proves my point. If we observed a pattern like that predicted by the organic

progression, it would strongly indicate that common descent was false and that the organic progression was true. In other words, Lamarck's organic progression predicts a non-nested pattern—if we observed that pattern, it would falsify common descent.

## A Non-sequitor and Outdated Science

Camp then tries to support this misunderstanding with another quote from Hunter:

"It has been known since Aristotle that species tend to cluster in a hierarchical pattern, and in the eighteenth century Linnaeus saw it as a reflection of the Creator's divine plan. Obviously this pattern does not force one to embrace evolution." ([Hunter 2001](#), p. 107.)

It seems clear to me that Hunter is implying that since the hierarchical pattern of species was known before the theory of common descent was proposed, then the hierarchical pattern cannot be used as evidence for common descent. According to such logic, Newton's Theory of Gravity is also suspect. It has been known since long before Aristotle that apples fall to the ground when dropped. Some people before Newton, such as Aristotle, thought that apples were attracted to the ground because they were primarily made of the "earth" element. Obviously this pattern (falling) does not force one to embrace the inverse square law. It should be clear that the fact that people were wrong about physical explanations in the past is not an argument against modern scientific theories.

However, in private correspondence, Hunter has vociferously objected to my interpretation of his comments given above. Hunter claims that he was simply pointing out that alternative "theories" can explain the observed nested hierarchy. For such a point to be valid, the alternate "theories" would need to be of equal scientific rank as the theory of common descent. To my knowledge, neither Aristotle nor Linnaeus proposed any hypothesis concerning the nested hierarchy, and neither of them ever made any testable predictions based on any hypothesis proposed to explain the nested hierarchy. In contrast, common descent has certainly been proposed as a hypothesis which predicts the nested hierarchy, and many predictions based upon universal common descent have been made and tested by evolutionary biologists within the past 140 years. As such, the philosophical and theological ideas of Aristotle and Linnaeus do not compete scientifically with the formal hypothesis of common descent. Furthermore, there is no reason why the theological significance Linnaeus attached to the nested hierarchy should exclude common descent. It is possible for a theist to see the theory of common descent, and the hierarchy which it predicts, as a reflection of the Creator's divine plan—much as Sir Isaac Newton saw his laws of motion, and the ellipses and parabolas which they predict, as evidence of the Creator's hand in our universe.

## A Red Herring: 19th Century Science is Not Modern Science

Hunter's quote continues:

"Also, Darwin's law of natural selection does not predict this pattern. He had to devise a special explanation—his *principle of divergence*—to fit this striking pattern into his overall theory." ([Hunter 2001](#), p. 108.)

Branching or divergence of species (i.e. speciation) is an inherent part of common descent. Darwin's *principle of divergence of character* was his particular explanation for speciation, for how varieties eventually evolve to become separate species. It was not "devised" as a "special explanation"; Darwin cogently argued that it was a necessary result of natural selection.

"Natural selection, also, leads to divergence of character; for the more organic beings diverge in structure, habits and constitution, by so much the more can a large number be supported on the area, of which we see proof by looking to the inhabitants of any small spot, and to the productions naturalised in foreign lands. Therefore, during the modification of the descendants of any one species, and during the incessant struggle of all species to increase in numbers, the more diversified the descendants become, the better will be their chance of success in the battle for life. Thus the small differences distinguishing varieties of the same species, steadily tend to increase, till they equal the greater differences between species of the same genus, or even of distinct genera." (From the summary of Chapter 4, *Natural Selection*, Darwin 1872, p. 169)

However, Darwin's specific principle is unnecessary for common descent to produce a nested hierarchy—all that is necessary is speciation and change in characters, regardless of cause. Most importantly, the views of this 19th century naturalist, though interesting historically, are of no consequence whatsoever for the validity of modern evolutionary theories. Camp's insertion of Darwin's views into a debate about modern science is a red herring (or a straw man, either one). Camp has replied:

According to Dr. Theobald, Darwin's principle of divergence is simply another name for ("is otherwise known as") common descent. The principle of divergence was an addition to the bare notion of common descent that "Darwin believed necessary to account for the diverging, tree-like relationships of organisms" (quote from the Darwin Project at the University of Cambridge, <http://www.lib.cam.ac.uk/Departments/Darwin/intros/vol6.html>).

As stated above, Darwin's "principle of divergence of character" is outdated 19th century science, not modern science, so the point is moot. That said, Camp is incorrect and has misrepresented Darwin's thinking. The following discussion, in the orange box, is solely for clarification of Darwin's views.

Darwin's principle of divergence was not "an addition to the bare notion of common descent"—if anything, it was an addition to the bare notion of natural selection. In fact, Darwin saw the "principle of divergence" as a *deduction* from natural selection acting on closely related populations in different environments. As Darwin states in his introduction to **The Origin of Species**,

"This fundamental subject of natural selection will be treated at some length in the fourth chapter; and we shall then see how natural selection almost inevitably causes much extinction of the less improved forms of life, and leads to what I have called divergence of character." (Darwin 1872, pp. 21-22)

"Natural selection, as has just been remarked, leads to divergence of character and to much extinction of the less improved and intermediate forms of life." (Darwin 1872, pp. 169-170)

"... it [the pattern of nested hierarchies] is explained through inheritance and the complex action of natural selection, entailing extinction and divergence of character, as we have seen illustrated in the diagram." (Darwin 1872, p. 170)

It is possible to have common descent without natural selection, and it is possible to have natural selection without common descent. Darwin's principle tied the two together. As stated above, Darwin's "principle of divergence of character" was his particular explanation for how natural selection led to speciation, as Darwin wrote:

"Undoubtedly there is one most important point of difference between varieties and species, namely, that the amount of difference between varieties, when compared with each other or with their parent-species, is much less than that between the species of the same genus. But when we come to discuss

the principle, as I call it, of divergence of character, we shall see how this may be explained, and how the lesser differences between varieties tend to increase into the greater differences between species." ([Darwin 1872](#), pp. 84-85)

In Chapter 4, Darwin formally introduces and explains his "principle of divergence of character." There he clearly postulates it as a consequence of natural selection working on similar populations in different environments, thus leading to speciation. Darwin begins his section on the principle of divergence with a question:

"The principle [of divergence] is of high importance, and explains, as I believe, several important facts. In the first place, varieties, even strongly-marked ones, though having somewhat of the character of species [...] yet certainly differ far less from each other than do good and distinct species. Nevertheless according to my view, varieties are species in the process of formation, or are, as I have called them, incipient species. How, then, does the lesser difference between varieties become augmented into the greater difference between species?" ([Darwin 1872](#), p. 143)

Darwin answers this question with his principle of divergence, and he explains how it can act in both domesticated and wild organisms. Then, he uses his proposed concepts of (1) speciation by the principle of divergence and (2) change by natural selection to demonstrate how a branching tree-like genealogy of species will naturally develop:

"After the foregoing discussion [of the principle of divergence], which has been much compressed, we may assume that the modified descendants of any one species will succeed so much the better as they become more diversified in structure, and are thus enabled to encroach on places occupied by other beings. Now let us see how this principle of benefit being derived from divergence of character, combined with the principles of natural selection and of extinction, tends to act.

The accompanying diagram will aid us in understanding this rather perplexing subject. ..." ([Darwin 1872](#), p. 148-150)

Darwin then describes common descent using his [famous figure](#), the [tree-like phylogeny](#), which graphically represents the predicted nested hierarchies. Note that the nested hierarchy is a consequence of only speciation and change in character, which Darwin explained by use of the principle of divergence and natural selection, respectively. From this discussion it is clear that Camp is incorrect to state that the "principle of divergence was an addition to the bare notion of common descent." The principle of divergence was combined with evolution by natural selection to *deduce* common descent with nested hierarchies. In fact, anytime there is speciation, that is also common descent, so in a sense the principle of divergence *is* common descent (though it is a special case caused by the action of natural selection on different populations in different environments).

## More Misrepresentation of Evolutionary Theory and Misunderstanding of the Scientific Method:

### Walter ReMine's Views of the Nested Hierarchy

Camp appears to be confused about whether common descent must include branching of species or not:

Even a mechanism of descent that includes branching events does not ensure a nested pattern.

If multiple species evolved from a common ancestor, how could they have arisen without branching? "One" turning into "two" necessarily includes a branching event. Divergence (i.e. speciation) is thus *inherent* in the concept of common descent. Again, think about a family tree. Genealogies branch and diverge. The very essence of common descent is that all species are related like individuals in a genealogy.

Camp then quotes ReMine in support of his misunderstanding of the prediction of nested hierarchies:

"The pattern of descent depends on the extent that evolved characters are later lost. Suppose losses are significant, and characters are replaced at a high rate. Then there is no reason to expect a nested pattern. Descendants could be totally different from their distant ancestors and sister groups, with little or no semblance of nested similarities linking them." (ReMine, 343.)

ReMine is partially correct, yet errs large. If rates of evolution are fast, then the cladistic information indeed can be lost given enough time, since the cladistic information would be essentially randomized. The faster the rate, the less time needed to obliterate the information in biological characters about the historical branching pattern of evolution. Slowly evolving characters let us see farther back into time; faster evolving characters restrict that view to more recent events. This is a difficulty that biologists must deal with in reality. But, importantly, it is also a prediction of common descent. Given a certain rate of evolution, we can determine how long it will take for cladistic information to be lost. ReMine forgets that "rate of evolution" vs. "time since divergence" is relative; thus, in some time frame we will always be able to observe a nested hierarchy if common descent is true. Furthermore, we know empirically that background mutation rates vary by orders of magnitude from locus to locus in the genomes of species. This fact means that hierarchies should be observed at many biological levels, since some genes evolve faster or slower than others.

ReMine thinks that since there are certain conditions under which a prediction of our theory will not be observed, then observing the prediction is not a confirmation of our theory. If this were true, we could never confirm any scientific hypothesis, not just common descent, since there are always certain conditions under which we will be unable to observe some consequence of a theory.

All ReMine is saying is that, under certain conditions, common descent predicts that hierarchical structure will be randomized. It is unclear why this is a problematic feature of the theory of common descent. Under certain conditions, Newtonian theory predicts that objects will not follow elliptical orbits, but that they will follow parabolas. Are we thus supposed to conclude that observing the elliptical orbits of the planets cannot be used as evidence for Newtonian theory? No, and the same is true for common descent. This is the same error as Hunter's "A and not-A" discussion addressed above. ReMine simply does not understand how the scientific method works.

Camp has since contested my criticism of ReMine's arguments:

This is a mischaracterization of ReMine's position. ReMine is not claiming that fulfillment of a theory's falsifiable prediction (e.g., the mutual attraction of two masses decreases in proportion to the square of the distance between them) is nullified by an inability to test the prediction under certain circumstances (e.g., where the attraction is predictably below measurable limits).

The phrase "inability to test" is misstated. We can *always* test—it is only *after* testing that we compare the results to our predictions. Camp's misstatement is just a further indication of an underlying misunderstanding and unfamiliarity with scientific practice. If we assume that something is untestable beforehand then we are assuming the truth of our theory—we are not testing it. How could we know that the attraction between two objects is "predictably below measurable limits" unless we are already assuming that the Theory of Gravity is true? We cannot; we must test that prediction and see if we really are unable to measure the attraction when, using our theory, we predict that the attraction should be too small to measure.

What Camp must mean here, to make sense, is "inability to observe a given prediction" instead of "inability to test." In fact, this *is* exactly what ReMine is claiming—there is no mischaracterization. ReMine claims that fulfillment of a theory's falsifiable prediction (e.g., the observation of a "nested pattern") is nullified by an inability to observe the prediction under certain circumstances (e.g., when the hierarchy is predictably randomized because "losses are significant, and characters are replaced at a high rate"). As stated above, this claim is identical to Hunter's "A and not-A" equivocation. Theories predict a range of outcomes; observing one of those outcomes and not the others (contingent upon the relevant conditions) is still evidence for the theory.

Rather, he [ReMine] is claiming that nested hierarchy is not a falsifiable prediction of common ancestry because the theory includes without restriction processes that work against that pattern. Those processes can be invoked in any blend to account for any non-nested pattern that is observed.

Well, ReMine is *also* making this claim. However, ReMine and Camp are both incorrect in stating that it is problematic to invoke processes that "work against" a prediction of a theory. For example, with Newton's Theory of Gravity, there are plenty of things that can be invoked to account for anomalous results. For instance, naively, feathers and bowling balls supposedly fall at the same rate. If dropped from the same height, they should hit the ground at the same time—that is, if the theory is correct. But we all know that is untrue. Feathers fall more slowly, and we invoke another process, air resistance, to explain why feathers fall in a way not predicted by the theory. But there is more—electrons and protons do not follow the gravitational inverse square law either. We invoke electric charge to explain that. Refrigerator magnets also "violate" the Theory of Gravity. Here we invoke a process, magnetism, that works against the patterns predicted by Newton's theory. In some cases, like three- or four-body problems, we admit that Newton's theory fails to give an exact answer. When we are only considering two objects, like the Sun and the earth, we can solve the equations of motion exactly. But add just one more element, like the moon, and the equations are impossible to solve (though the answers can sometimes be approximated). In other cases, as with the orbit of Mercury, we drop Newton's theory altogether and invoke relativistic effects.

In reality, *all* scientific explanations are complex, except in the most unrealistic, contrived situations found in carefully controlled laboratory environments. In a lab, we can remove the air from a container and watch a bowling ball and a feather fall at the same rate. In contrast, we cannot simplify things like that when we try to calculate the terminal velocity of a falling body in our atmosphere. As stated elsewhere here, processes cannot "be invoked in any blend to account for any [...] pattern." Complex explanations are required to be reasonable and to conform to empirically observed processes—they are not invoked "without restriction." All the processes that ReMine and Camp complain about have been empirically observed, and they are testable propositions. Evolutionary biology, thus, is no more problematic than any other scientific discipline. To repeat, ReMine simply does not understand how the scientific method works.

Mr. Camp uses an additional quote from ReMine with the intent to criticize common descent and the prediction of nested hierarchies:

"Evolution does not predict a hierarchical pattern. Simple processes of loss, replacement, anagenesis, transposition, unmasking, or multiple biogenesis would prohibit such a pattern. Since hierarchical patterns (such as cladograms or phenograms) are not predicted by evolution they are not evidence for evolution." (ReMine 1993, p. 444.)

However, Camp has misquoted ReMine. ReMine is not specifically referring to common descent in this passage; he is writing about evolution *in general*. ReMine keeps common descent and evolution distinct (as he should). For instance, multiple biogenesis is not common descent. This is clear from the very next sentence that follows the quote above:

"Life's hierarchical pattern (as displayed in cladograms and phenograms) is too indirect to establish even the special case of common descent." (ReMine 1993, p. 444.)

ReMine considers common descent to be a special case of evolution, which of course it is. But his point that common descent is not a *necessary* case of evolution is senseless. It is analogous to criticizing the inverse square law because it *could* have been an inverse cube law or an inverse factorial law. He might as well say—"Gravity does not predict elliptical orbits. Since elliptical orbits are not predicted by gravity then it is not evidence for gravity." Which he could have followed with—"Elliptical orbits (as displayed by planets and projectiles) are too indirect to establish even the special case of the inverse square law." Despite ReMine's protestations, nested hierarchies are measurable features of organisms—their presence or absence can be quantified and evaluated with statistics. The prediction of a nested hierarchy follows directly from the hypothesis of common descent.

Furthermore, ReMine is incorrect in claiming that "loss, replacement, anagenesis, transposition, unmasking, or multiple biogenesis would prohibit" a hierarchical pattern. Of course, multiple biogenesis could, but we are not considering multiple biogenesis, we are considering universal common descent. The other processes mentioned all *create* hierarchical patterns, since character losses, replacements, anagenetic changes, transpositions, and reversals (unmasking events) are all inherited by descendants of an ancestor. For example, if all apes are descendants from a long-tailed primate common ancestor that lost its tail, then all apes will lack tails, while other primates will have tails. If an ape acquired a gene by transposition into the germ-line, then all descendants of that ape would inherit that transposition. If some non-ape primate then had a short tail replace its long tail, then all descendants of the short-tailed primate would inherit that short tail. The result is a nested hierarchy.

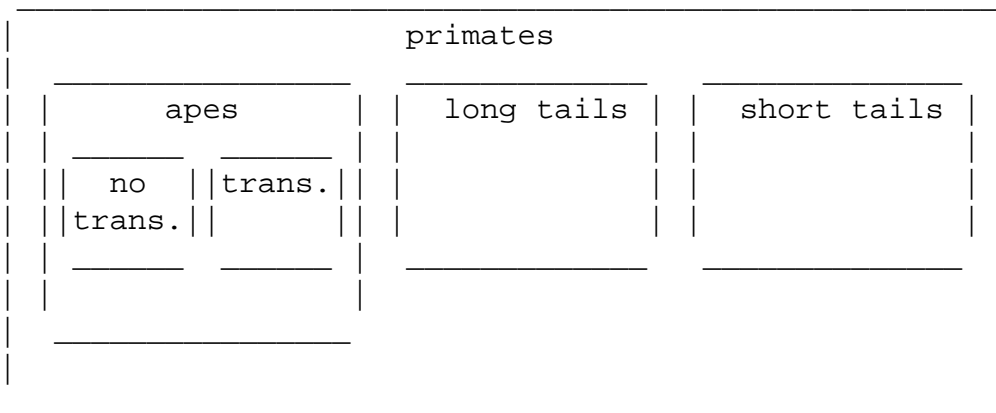

These "simple processes" are the very types of things that make nested hierarchies.

Since this was written, Camp has [replied](#):



There are various ways in which existing organisms could descend from a common ancestor and not exhibit a nested hierarchy. Anagenesis, loss of characters, replacement of characters, transposition of characters, atavism (masking and unmasking), and convergence all work against a hierarchical pattern, and the bare hypothesis of universal common ancestry says nothing about the rate or prevalence of those processes. They can be invoked in whatever blend is necessary to explain whatever pattern is found. Therefore, the claim that the hypothesis of universal common ancestry makes a falsifiable prediction that organisms will exhibit a pattern of nested hierarchy is incorrect.

Notice how Camp's reply avoids all of the points which were made against his argument. Camp does not provide us with an example of a non-nested pattern produced by common descent. He reiterates the claim that various processes "work against" a nested pattern, when in fact those very processes *create* a nested pattern. These processes cannot be "invoked in whatever blend is necessary to explain whatever pattern is found." Yes, "bare" common descent may not state anything specifically about these processes, but universal common descent *is* constrained by gradualism, as has been explained many times over. We know empirically the maximum rates of anagenesis, character loss, and character replacement—such processes can be used in scientific explanations, of course, but there are limits on what rates can be used. This was already addressed specifically in predictions [22](#), [23](#), [24](#), [28](#), and [29](#). Furthermore, we also know that convergence happens (it is a prediction of natural selection and is observed regularly in the wild and in the lab). However, true structural convergence, in which distantly related taxa perform the same functions with the same underlying structures, is rare relative to divergence. In fact, when considering DNA sequence evolution, we can calculate very precisely what rates of convergence are reasonable and what rates are highly unlikely.

### Michael Denton's Views of the Nested Hierarchy

Camp then goes on to quote another confused anti-evolutionist, Michael Denton, in support of his assertion that common descent does not predict a nested hierarchy:

"In the final analysis the hierarchic pattern is nothing like the straightforward witness for organic evolution that is commonly assumed. There are facets of the hierarchy which do not flow naturally from any sort of random undirected evolutionary process. If the hierarchy suggests any model of nature it is typology and not evolution. How much easier it would be to argue the case for evolution if all nature's divisions were blurred and indistinct, if the *systema naturalae* was largely made up of overlapping classes indicative of sequence and continuity." ([Denton 1986](#), 136-137.)

In evolution, "sequence and continuity" are truly only displayed in the time dimension. Horizontal slices of time may hint at continuity, especially between closely related species—but branching and divergence from a common ancestor predicts nested hierarchies at any given time, not a continuum. Denton simply did not understand common descent when he wrote this passage (his views have since changed). Common descent is the hypothesis that all species are strictly genealogically related. That means that species should be organizable into a family tree. It is very easy to see that a family tree gives nested hierarchies at any given single point in time. If all of nature were "blurred and indistinct," if the "*systema naturalae* was largely made up of overlapping classes," this would not indicate common descent, it would indicate something like Lamarck's organic progression or the medieval view of the "great chain of being." Camp has replied to these comments:

Next, Dr. Theobald chides me for quoting "another confused anti-evolutionist," Michael Denton. As an aside, I find it fascinating that, according to Dr. Theobald, Denton "doesn't understand even the most fundamental evolutionary concepts." It is fascinating because one often hears that nothing in biology makes sense except in light of evolution. And yet, Denton, being ignorant of the most fundamental evolutionary concepts, managed to earn a Ph.D. in developmental biology (in addition to an M. D.), to write or co-author over seventy articles in professional journals, and to work for decades as a genetics researcher. Apparently knowledge of evolution is irrelevant to a career in science.

I am confident that Michael Denton has contributed greatly to scientific knowledge in his area of expertise. Yet, Camp's logic here is wanting. Someone can have a successful scientific career, especially in an applied field, without understanding the theory behind the science they practice. Plenty of people drive cars and fly in planes who understand not a thing about how cars and planes work. Most people who consider themselves "computer literate" don't really understand how computers do their thing at the most basic level (and I count myself among them). I can program with languages such as sed, awk, Perl, Python, C, C++ and some Java and Fortran—but that doesn't mean I understand how to make a functional silicon computer chip. Even silicon chip designers often know extremely little quantum mechanics, even though electromagnetic theory and quantum mechanics ultimately explain the behavior of all electronic devices. Likewise, someone can be a good medical doctor without understanding why the drugs they prescribe work effectively, and someone can do plenty of good biological research without understanding evolutionary biology. Nevertheless, nothing in computing makes sense except in the light of microchip technology, nothing in microchip technology makes sense except in the light of quantum mechanics, nothing in the automobile industry makes sense except in the light of mechanics and thermodynamics, nothing in aviation makes sense except in the light of aerodynamics, nothing in medicine makes sense except in the light of biochemistry, and nothing in biology makes sense except in the light of evolution.

It is not to the benefit of Camp's argument that he uses quotes from Denton's book, **Evolution: A Theory in Crisis**. This book is ridden with errors, false "facts," illogic, and uninformed dialectics. As one of a myriad of examples, immediately preceding the paragraph quoted by Camp above, Denton writes:

"There is another stringent condition which must be satisfied if a hierarchic pattern is to result as the end product of an evolutionary process: *no ancestral or transitional forms can be permitted to survive.*" ([Denton 1986](#), p. 136, emphasis in the original).

This is false and nicely illustrates the wanton ignorance concerning basic evolutionary concepts displayed in this book. This passage is, additionally, directly pertinent to the present discussion of nested hierarchies. Denton immediately follows the above statement with:

"This can be seen by examining the tree diagram above on page 135. If any of the ancestors X, Y and Z, or if any of the hypothetical transitional connecting species stationed on the main branches of the tree, had survived and had therefore to be included in the classification scheme, the distinctness of the divisions would be blurred by intermediate or partially inclusive classes and what remained of the hierarchic pattern would be highly disordered." ([Denton 1986](#), p. 136)

The absurdity of these statements is evident when one includes the ancestors X, Y, and Z in Denton's nested hierarchy figure. All the ancestors (including a hypothetical transitional connecting species, **W**) fit in the existing nested hierarchy just fine, without blurring the distinctness of divisions or contributing disorder to the hierarchical pattern. If the author could not even work out the simple evolutionary predictions based upon his very own figures and examples, it is no wonder that he wrote that "the hierarchic pattern is nothing like the straightforward witness for organic evolution that is commonly assumed."

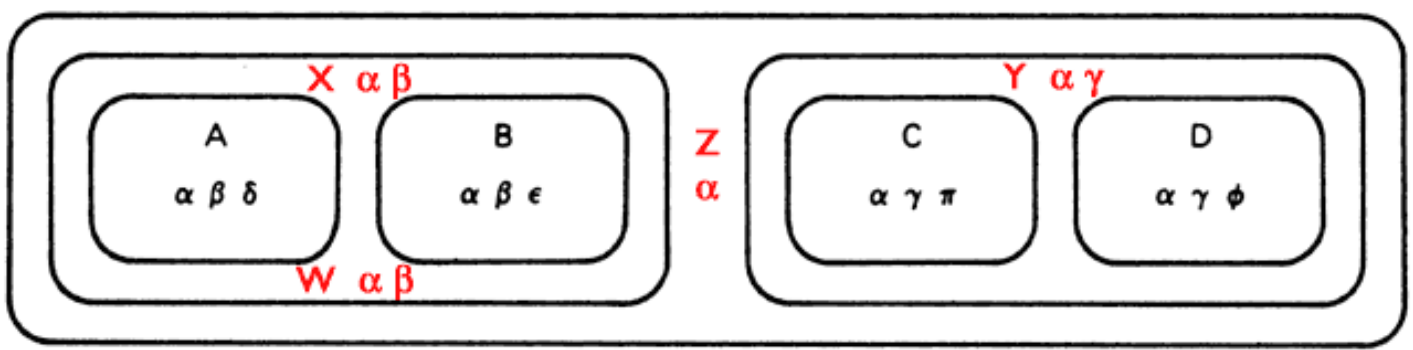
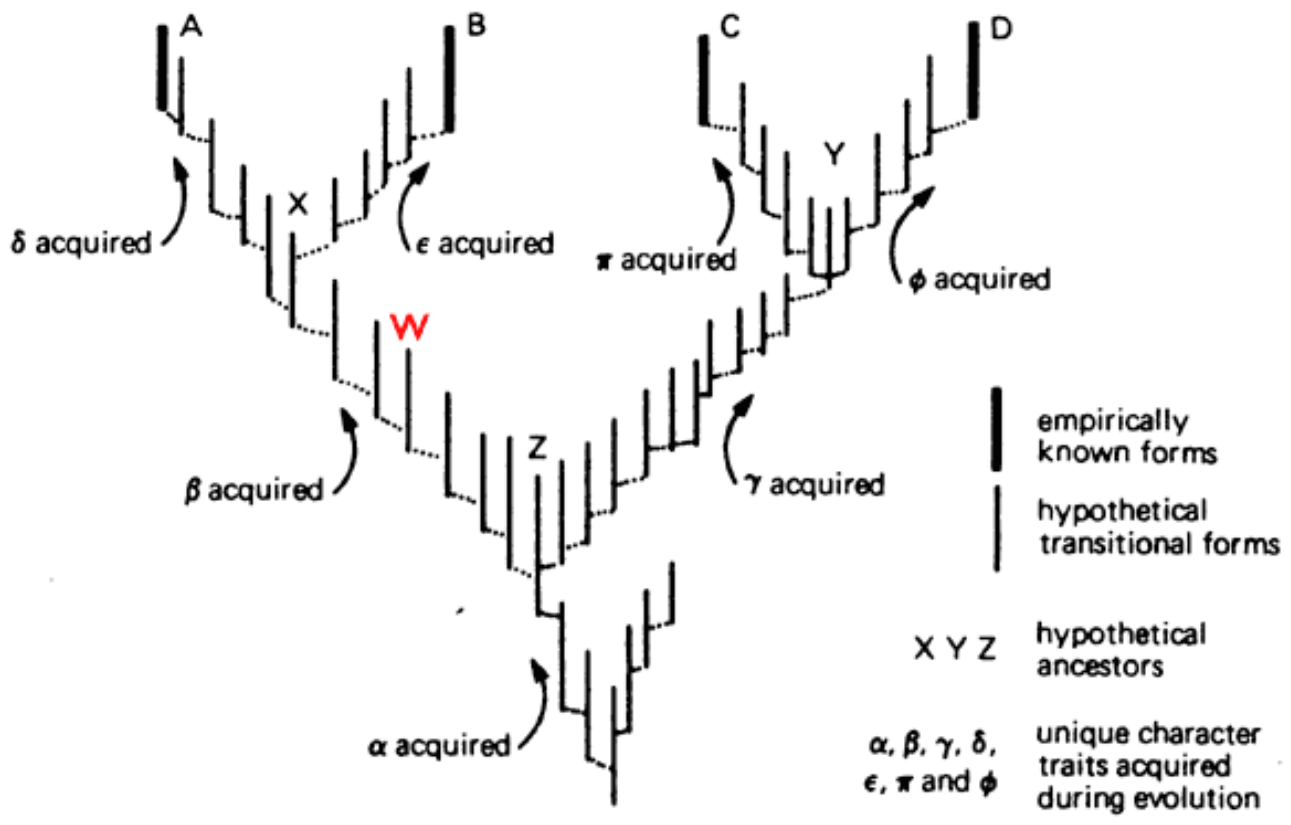

**Figure C2.** A phylogeny and the corresponding nested hierarchy, as given by Michael Denton ([Denton 1986](#), p. 134-135). Denton's figure is reproduced in black. Additions by Theobald are shown in red. (Figure reproduced with permission from Random House Publishers.)

Dr. Theobald's disparaging comment notwithstanding, Denton's point about the nested hierarchy observed in nature has merit. The discreteness or discontinuity of the groupings does not flow naturally from a random, undirected evolutionary process. One must explain why the morphological space between the groups exists, as opposed to the divisions being blurred and indistinct. The point is not that evolutionists cannot explain it but that it is something that requires an explanation.

If that is the point then it is a moot one for our present discussion. All natural phenomena require an explanation, scientifically. Is there supposed to be something problematic about that? In fact, "discreteness

or discontinuity of the groupings" *does* "flow naturally from a random, undirected evolutionary process." Extinction is an observable fact, both in the fossil record and in the present. Extinction is all that is needed to cause discontinuity (though other processes can also be involved). Extinction is also largely random and undirected.

Interestingly, it appears that Denton has finally rectified his misunderstanding about nested hierarchies and common descent, since in his latest book he unconditionally assumes the validity of the nested hierarchy, common descent, and the "tree of life" ([Denton 1998](#), pp. 265-298). For example, in the chapter entitled *The Tree of Life* from **Nature's Destiny**, Denton discusses the phylogeny of several closely related species (the primates) and directly contradicts his previous misstatements presented by Camp above:

"In the case of primate DNA, for example, all the sequences in the hemoglobin gene cluster in man, chimp, gorilla, gibbon, etc., can be interconverted via single base change steps to form a perfect evolutionary tree relating the higher primates together in a system that looks as natural as could be imagined. There is not the slightest indication of any discontinuity." ([Denton 1998](#), p. 277)

This was written by the same man who scribed:

"Each class at a molecular level is unique, isolated and unlinked by intermediates. Thus, molecules, like fossils, have failed to provide the elusive intermediates so long sought by evolutionary theory." ([Denton 1986](#), p. 290)

One wonders how Camp can feel justified in quoting Denton's past confusions about common descent. Camp has responded to this:

Dr. Theobald apparently misunderstands Denton's point in the quote, as he claims that Denton subsequently contradicted himself in opining that the hemoglobin gene cluster in primates was not discontinuous. Just because Denton believes there is no discontinuity requiring an explanation in that particular instance does not mean he denies there is discontinuity elsewhere. So Dr. Theobald's comment ("One wonders how Camp can feel justified in quoting Denton's past confusions about common descent") is misguided.

Contrary to Camp's later protestations, here Denton is not referring to primate DNA as an exception—he now sees it as an example of a generality of life. That is why Denton prefaces this case with "for example." One wonders if Camp has read Denton's new book.

## Unsupported Theology and Projection

At this point, Camp leaves science and enters into theological arguments:

The notion that the nested hierarchy of organisms is incompatible with creation is based, not on science, but on the unprovable theological assumption that if God created life he would do it in some other way. As biologist Leonard Brand explains:

The hierarchical arrangement of life illustrated in Fig. 9.6 has been used by Futuyma (1983) and others as evidence that life must have evolved. They believe that if life were created, the characteristics of different organisms would be arranged chaotically or in a continuum, not in the hierarchy of nested groups evident in nature. If we think of that concept as a hypothesis, how could it be tested? Actually, to state how a Creator would do things and then show that nature is or is not designed that way is an empty argument. Such conjecture depends on the unlikely assumption that we can decide what the Creator would be like and how he would function. (Brand, 155.)

In fact, no theological assumptions or arguments are made at all in the essay. The "29 Evidences" is not an argument against creation—it is the scientific argument for common descent, no more, no less. The evidence for common descent can only be evidence against creation if one believes the two are mutually incompatible. A belief that Divine creation and common descent are mutually exclusive alternatives is indeed a theological assumption, and it is one that Ashby Camp makes, not I.

If Camp has independent evidence that a Creator has created life to result in a nested hierarchical classification, let him present that evidence. If the hypothesis that a Creator created in this manner is testable and falsifiable, let Ashby Camp tell us how. Personally, I agree with Brand when he says that "to state how a Creator would do things and then show that nature is or is not designed that way is an empty argument. Such conjecture depends on the unlikely assumption that we can decide what the Creator would be like and how he would function" ([Brand 1997](#), p.155). Camp also concurs, as he says that predictions about how God would create are "based, not on science, but on the unprovable theological assumption that if God created life he would do it in some [specific] way." The creation hypothesis that a Creator created life with nested hierarchies is therefore not scientific; as Brand and Camp note, it is untestable. It is highly ironic that Camp has tried to turn a fatal weakness of creationism into a weakness of the theory of common descent.

Throughout his criticism, indeed in every section, Camp relentlessly accuses me of making theological assumptions which I do not make. Frankly, I find this to be offensive, since in reality it is Ashby Camp who makes the theological assumptions and then projects his bias on me. I personally believe that an omnipotent, omniscient Creator could have created in any manner that he chose. For a theist, the pertinent question is not "what is an omnipotent Creator capable of?" but rather "how exactly did/does the Creator create?". The first question is purely theological, and as such is left unaddressed in the "29 Evidences"; in contrast, the second question is one that science can answer (given the assumption of a Creator).

The "29 Evidences" concerns *scientific* evidence only—that means *only* hypotheses which can be tested against hard empirical evidence, *only* hypotheses that can be either confirmed or falsified in principle. Unfortunately, Camp forwards numerous scientifically meaningless, untestable "creation hypotheses" throughout his critique, apparently under the self-deceiving illusion that they have some relevance to the present issue. However, in the quoted section above, Camp states outright that conjecture about how a Creator created is not scientific, because such conjecture cannot be tested and because we cannot know the Creator's intent in the first place. Thus, every alternative "creation hypothesis" that Camp proffers is irrelevant by his own admission.

Camp has written in defense of his unsubstantiated theological accusations:

Dr. Theobald next charges me with wrongful imputation of a theological assumption. ...

First, everyone realizes that universal common ancestry is compatible with certain theories of divine creation (e.g., theistic evolution). However, it is incompatible with the claim that the founding members of various groups were created separately by God. That claim is a specific case of non-universal common ancestry. So "29 Evidences for Macroevolution" is an argument against creation in that sense.

If Camp is correct, then *all* scientific theories and conclusions are arguments against some creation "theory." Amos 4:13 states that God creates the wind (the Hebrew verb for "create" here, "bara," is the same as that in the first chapter of Genesis). Does that mean that meteorology is an argument against Divine creation? Someone who reads Amos "literally" could argue that God separately creates all winds. Thus, appeals to "highs" and "lows" or "cold fronts" and "warm fronts" are all arguments against the separate creation of winds. In fact, by Camp's logic, all scientific theories are arguments against God's direct Divine intervention in some phenomenon that we observe. If electromagnetic theory is true, that means that God does not miraculously cause magnets to stick to refrigerators or cause positively charged things to attract negatively charged things.

Though I disagree, suppose for the sake of argument that Camp is correct that scientific conclusions are necessarily arguments against direct Divine action. Just because we conclude something does not mean that we *assumed* that conclusion in the premises of our argument. Just because one could (in principle) conclude from the "29 Evidences" that God did not separately create species does not mean that was an assumption of the argument. Camp's first point, thus, does nothing to support his accusation that I have made certain theological assumptions (against special creation) in the arguments presented in the "29 Evidences."

Note, however, that Camp is strictly incorrect to state that common ancestry is necessarily "incompatible with the claim that the founding members of various groups were created separately by God." As I pointed out earlier in the discussion here of [Prediction 2](#), God could have created all species independently and miraculously, yet gradually—a theological position compatible with universal common descent. *Gradual* Divine direction of evolution is consistent with universal common descent, even though there is currently no scientific evidence for such a belief. This concept has been pointed out before by other evolutionary biologists—see, for instance, the conclusion of Kathleen Hunt's [Transitional Vertebrate FAQ](#), in the discussion of possible [consistent models](#), especially "[model 5](#)."

So, Camp does not simply assume that Divine creation and common descent are necessarily mutually exclusive alternatives. Camp also makes the additional theological assumption that God could not have created species (founding members and/or others) independently *and* gradually. In contrast, no such theological assumptions (or conclusions) are made in the "29 Evidences."

## More Unfamiliarity with the Scientific Method

Camp continues in defense of his accusations:

Second, if evidence is compatible with separate creation by God (non-universal common ancestry), it is not probative of the contrary proposition (universal common ancestry). Since one can judge nested hierarchy to be incompatible with separate creation by God only if one assumes that God would not separately create organisms in a nested hierarchy, the inference of universal common ancestry from the evidence of nested hierarchy contains a latent theological assumption. Because Dr. Theobald is unaware of this, he takes great umbrage at what he perceives to be my erroneously attributing the assumption to him. His pique is unwarranted.

Once again, Mr. Camp persists in accusing me of making a theological assumption which I do not make. Nowhere in the "29 Evidences" is it stated that "God would not separately create organisms in a nested hierarchy" or anything similar. Nowhere is it stated or implied that God would or would not create or do anything in *any* manner. Of course God could have created organisms in a nested hierarchy. If there is scientific evidence for this, then perhaps Mr. Camp should present it.

Yet again, this sophistry evidences an unfamiliarity with the scientific method. The first sentence in Camp's quote above is false. In science, evidence can be compatible with a hypothesis and still be "probative of the contrary position" (for those, like me, who are unfamiliar with the words "[probative of](#)"—here it means "evidence for"). Camp insists that the "evidence is compatible with separate creation by God," which of course it is, but that is a moot point as far as science is concerned.

Scientific theories are not judged simply by their compatibility with the evidence and data. All physical evidence and data are *compatible* with an infinite number of unscientific "hypotheses." As a simple extreme example, I could hypothesize that the entire universe was miraculously created 5 minutes ago, with everything already set in place to appear as if it were much older (our memories included). Such a hypothesis is completely compatible with the available evidence and data. Go ahead, prove me wrong! And there lies the rub—this hypothesis is not scientific because there is no possible evidence that could stand in contradiction to its predictions. Any and all evidence is compatible. It is untestable in principle, even though it is logically consistent with the data—but we since cannot test it, we have no scientific reason to conclude that it is likely, and thus it is not scientific. Ironically, Camp himself went to great lengths to make this very point about special creation and the nested hierarchy. Camp stated:

The notion that the nested hierarchy of organisms is incompatible with creation is based, not on science, but on the unprovable theological assumption that if God created life he would do it in some other way.

Camp quoted Brand in support:

"to state how a Creator would do things and then show that nature is or is not designed that way is an empty argument. Such conjecture depends on the unlikely assumption that we can decide what the Creator would be like and how he would function" ([Brand 1997](#), p.155).

Obviously Camp agrees that there is no way to prove this theological assumption wrong. Therefore, we both agree that is not scientific. This is true even though this "creation hypothesis" is *logically consistent with the evidence*. The "29 Evidences," however, concerns not what is simply logically consistent with the data. The "29 Evidences" concerns scientific evidence, testable hypotheses, and scientific conclusions. Supposedly, *that* was also the object of Camp's criticism. Camp began his rebuttal with these words:

In "29 Evidences for Macroevolution," Dr. Theobald sets forth the evidence that he believes proves scientifically that all organisms share the same biological ancestor. In this critique, I argue that his evidence is insufficient to establish that proposition.

In contrast to his claims, Mr. Camp is preoccupied with establishing the trivial fact that special creation by miraculous means is logically "compatible" with the evidence—an obvious point which is essentially inarguable. However, this point has nothing to do with science. Camp's "Critique" of the scientific evidence concerns unprovable theological assumptions, not scientific testability.

Camp continues with his original critique:

It may be that the nested hierarchy of living things simply is a reflection of divine orderliness. It also may be, as Walter ReMine suggests, that nested hierarchy is an integral part of a message woven by the Creator into the patterns of biology. (See, e.g., ReMine, 367-368, 465-467.) The point is that the hierarchical nature of life can be accommodated by creation theory as readily as by evolution. Accordingly, "[i]t is not evidence for or against either theory." (Brand, 155.)

Creation theory can, to my knowledge, accommodate any possible outcome and is therefore untestable, unfalsifiable, and unscientific. If Camp has an opposing view and has examples of observations that would falsify creation theory, let him present them. Common descent, on the other hand, cannot accommodate any outcome; common descent predicts observable nested hierarchies. If rates of evolution are extremely fast (or extremely slow), nested hierarchies will be observed only for very recently diverged taxa (or for very distantly related taxa). Fortunately, we observe a range of evolutionary rates in different characters and thus observe nested hierarchies at many levels in biology.

It is worth pointing out here that it is in fact possible to have a "reciprocal" pattern from nested hierarchies. Mathematically, a nested hierarchy is the result of specific correlations between certain characters of organisms. When evolutionary rates are fast, the characters become randomly distributed with respect to one another, and the correlations are weakened. However, the characters could also be anti-correlated in theory—it is possible for them to be correlated in the opposite direction from what produces nested hierarchies, as discussed in [Prediction 2](#). The observation of such an anti-correlated pattern would be highly inconsistent with common descent, regardless of evolutionary rates.

## Confusion about Evolutionary Theory

Camp concludes his criticism of this point with an attack on the very notion of cladistic classification:

Dr. Theobald's claim that "specially designed objects like buildings, furniture, cars, etc." cannot be classified in a nested hierarchy requires elaboration. In terms of mere classification, it is incorrect. Buildings and vehicles have both been used as examples of nesting ([Ridley 1993](#), 52-54; Fastovsky and Weishampel, 51-53; Brand, 165-166).

Camp's assertion stems from a misunderstanding, one that is addressed in detail in the new version of the "29 Evidences" under [prediction 2](#). Some authors have used more familiar objects for illustrating nested hierarchies; however, these are only for explanatory purposes and are not meant to be strict analogies. Of course buildings and cars can be arbitrarily sorted into nested hierarchies. The point is that they do not



form *natural* nested hierarchies; they do not meet the mathematical requirements of nested hierarchies. Camp seems not to understand this point, in spite of the fact that one of his favorite anti-evolutionists explains it clearly:

"Any system of objects can be forcibly classified into a nested hierarchy. Some systems do not have to be forced, rather they display a nested pattern with clarity without having to be coerced. Life has such a pattern. There are no tetrapods that are not based on the vertebrate body plan. There are no amniotes that are not based on the tetrapod body plan. There are no mammals that are not also amniotes. These are the familiar examples, and many more can be given. They are powerful generalizations. Life is like nested Chinese boxes of subsets within subsets within subsets. Life is comprised of nested similarities. This significant pattern must be explained." ([ReMine 1993](#), p. 344)

And common descent explains it.

### A Classic [Out-of-Context Quote](#)

Camp concludes this misunderstanding with a quote from a well-known evolutionary biologist, which only appears to support his point:

"Any set of objects, whether or not they originated in an evolutionary process, can be classified hierarchically. Chairs, for instance, are independently created; they are not generated by an evolutionary process: but any given list of chairs could be classified hierarchically, perhaps by dividing them first according to whether or not they were made of wood, then according to their colour, by date of manufacture, and so on. The fact that life can be classified hierarchically is not, in itself, an argument for evolution." ([Ridley 1985](#), 8.)

Camp carefully and quite misleadingly omits the very next sentence:

"The argument for evolution comes from a particular property of the classificatory hierarchy, the kind of traits that define it." ([Ridley 1985](#), 8.)

Ridley goes on to make a good qualitative argument for the uniqueness of genealogically generated nested hierarchies, of how life's nested hierarchy is not "forced." Ridley was not arguing that organisms do not fall into natural nested hierarchies, as Camp implies. By omitting the additional sentence which I have provided, the Ridley quote appears to mean something other than it did in the original context. Thus, this is a classic example of the fallacy of [quoting out of context](#). Furthermore, Ridley was of course unaware of the more rigorously defined mathematical differences between "pseudo"-hierarchies of things like cars, chairs, or buildings and the real hierarchies of organisms or languages, because the mathematics for examining cladistic hierarchical structure was first worked out six years later, in 1991.

Camp has since [replied](#) to this criticism of his argument given above:

I wrote that "[i]n terms of mere classification," the statement was incorrect. To back up the claim that such specially designed objects can indeed be classified in a nested hierarchy (regardless of whether they possess genuine hierarchical traits), I pointed out that they are often used as examples of nesting.

It is in that context that I quoted Ridley. The point was that "[a]ny set of objects, whether or not they originated in an evolutionary process, can be classified hierarchically" (emphasis supplied), not that all sets of objects possess bona fide hierarchical traits. I omitted Ridley's statement that life exhibits a genuine hierarchy because it was irrelevant to my point. So Dr. Theobald has quoted me out of context in accusing me of quoting out of context! He then builds on his confusion in suggesting that I intentionally sought to mislead people ("Camp carefully and quite misleadingly omits the very next sentence").

First, I never suggested that Camp intentionally sought to mislead people. I *did* claim that Camp "carefully" omitted an important part of Ridley's statements, and Camp has admitted to that. I also claimed that omitting that sentence is misleading, which it is. It makes it appear as if Ridley meant something different from what he intended. Whether Camp *intentionally* wrote that line to mislead people is something only Camp himself can know.

Second, I did not quote Camp out of context. I included Camp's sentence "In terms of mere classification, it is incorrect." Third, it is now quite clear that Camp understands that there are important differences between artificial and "*bona fide*" nested hierarchies:

... I was not quoting Ridley to deny there is a difference between artificial and genuine hierarchies but only to support my contention that specially designed objects can be classified in a nested hierarchy ...

That is a very trivial point. It is irrelevant to the present discussion, since the issue at hand concerns genuine hierarchies like those found in life, not artificial hierarchies which can be arbitrarily constructed from specially designed objects. Someone could artificially classify pennies as "square rabbits," too. It is of course valid to state that pennies cannot be classified as squares or rabbits, because pennies obviously do not satisfy the requirements of geometrical squares or biological animals.

In this light, it is curious that Camp entered an extended discussion about how someone could artificially categorize certain non-hierarchical things in nested hierarchies. That point was not made in *Prediction 2* of the "29 Evidences"—so why include the Ridley quote to begin with? The point was simply that species form *natural* nested hierarchies, while chairs, books, the planets, the elements, and fundamental particles do not—and Camp evidently agrees. Was it a mistake to expect that Camp's arguments and supporting quotes were actually intended to be directed against the evidence for common descent? That is of course what I assumed when I read the Ridley quote, and I suspect many other readers made the same assumption.

### Prediction 3: Convergence of independent phylogenies

#### More Misrepresentation of Evolutionary Theory

Common descent predicts that independent determinations of phylogenetic histories should be similar. Once again, Camp denies that this is a prediction of common descent. However, this time, his basis for denial is the belief that this prediction has been falsified, and since scientists do not toss out common descent, this must not be a prediction of common descent. The error lies in the belief that this prediction has been falsified. Camp says:

The important point is that it is not a prediction of the hypothesis of common ancestry that phylogenies constructed from comparisons of biological molecules will match phylogenies constructed from comparisons of morphology. This is obvious from the fact molecular and morphological phylogenies often are inconsistent, and yet the hypothesis of common descent is not considered falsified. The discordant data are simply accommodated by the theory.

Camp is correct that often independently determined phylogenies are not exactly the same (i.e. they are incongruent). But in science, independent measurements of some value (such as a physical constant like the charge of the electron, the mass of the proton, or the speed of light) are never exact. There always exists some error in the measurement, and all independent measurements are incongruent to some extent. Of course, the true value of something is never known for certain—all we have are measurements that we hope approximate the true value. Scientifically, then, the important relevant questions are "When comparing two measurements, how much of a discrepancy does it take to be a problem?" and "How close must they be to be a strong confirmation?" Scientists answer these questions with probability and statistics. This issue is specifically addressed in the revised version of the "29 Evidences" under [prediction 3](#). The upshot is that the degree to which even the most incongruent trees match is extraordinary. Penny and Hendy have done a detailed statistical analysis of the significance of similar phylogenetic trees, and here is their conclusion:

"Biologists seem to seek the 'The One Tree' and appear not to be satisfied by a range of options. However, there is no logical difficulty in having a range of trees. There are 34,459,425 possible trees for 11 taxa ([Penny et al. 1982](#)), and to reduce this to the order of 10-50 trees is analogous to an accuracy of measurement of approximately one part in  $10^6$ ." ([Penny and Hendy 1986](#), p. 414)

For a more realistic universal phylogenetic tree with dozens of taxa including all known phyla, the accuracy is orders of magnitude smaller (better).

So Camp is incorrect on two counts. First, common descent does indeed predict that independently determined trees should be similar—if there really is a true genealogical tree of species, how could this not be the prediction? This is exactly why all the scientists that Camp quotes are concerned about incongruent trees.

Second, when analyzed statistically, the trees *are* stunningly similar—even the most incongruent ones. Incongruent trees are a "problem" in the sense that we biologists wish to attain perfection in our science, and incongruent trees are imperfect. Even so, the differences are just much too minor to falsify common descent; to the contrary, they confirm this prediction of common descent to a much higher degree than is found in any other scientific discipline.

Camp has offered a defense of his erroneous views:

Dr. Theobald misses the point in arguing that even the most incongruent phylogenies match to an extraordinary degree. Since his evidence is the alleged fulfillment of a falsifiable prediction, the issue is not the degree to which phylogenies match but the degree to which the bare hypothesis of common ancestry demands that they match. Without some constraint on the operation of processes that work against congruity, which constraint the hypothesis does not provide, nonmatching phylogenies are compatible with the hypothesis. There is no falsifiable prediction of congruity.

"The degree to which the bare hypothesis of common ancestry demands that [independently derived phylogenies] match" was and is clearly stated: **they must match with statistical significance** (for

more discussion see [Prediction 3](#)). This requirement has been stated, tested, and fulfilled in the primary scientific literature on several occasions ([Baldauf et al. 2000](#); [Penny and Hendy 1986](#); [Penny et al. 1982](#); [Penny et al. 1991](#)). Since it was possible, indeed highly probable, for phylogenies to match without statistical significance or to *mis*-match with statistical significance, the prediction of congruity is easily falsifiable if common descent is false. Thus, Camp is wrong on this account, and he has failed to even address the real issue (the extremely high statistical significance of the match between independently derived phylogenies).

## A Self-contradiction—the [Fallacy of Inconsistency](#)

Unfortunately, Camp's argument is fundamentally flawed at a much deeper level. Camp contradicts himself; in his eagerness to "disprove" common descent, Camp simultaneously argues for two opposing views. Camp states:

... molecular and morphological phylogenies often are inconsistent, and yet the hypothesis of common descent is not considered falsified. The discordant data are simply accommodated by the theory.

and follows with this a few paragraphs later:

The availability of such ad hoc adjustments for resolving incongruities makes the claim of falsifiability an illusion. Any result can be accommodated by the theory by revising one or more of the underlying assumptions.

Why is there any discordant data if any result is changed at will with *ad hoc* revising of the assumptions? These statements are contradictory, and both cannot be true. In fact, both are false. Camp has objected to my analysis here:

... there is no contradiction in saying that inconsistent molecular and morphological phylogenies are discordant data and saying that such inconsistencies can be accommodated by ad hoc adjustments.

However, that was not Camp's original claim. He was claiming that inconsistent phylogenies exist *in the scientific literature* and that incongruities are generally resolved in practice by *ad hoc* adjustments (e.g. "the obvious point that assumptions are adjusted to accommodate discordant data" and "discordant data are simply accommodated by the theory"). That claim is self-contradictory, since differences between phylogenies in the scientific literature cannot be both inconsistent and accommodated simultaneously.

Note that, if this is *not* really what Camp meant, then he has no valid point. Just because inconsistencies *can* be accommodated, in principle, by invoking *ad hoc* arguments does not mean that scientists actually do so or that this kind of 'assumption-adjusting' is considered fair game. In principle, all possible conflicting observations in any scientific discipline can be made consistent with any theory by invoking *ad hoc* arguments (formally known as the Duhem-Quine thesis). Therefore, if Camp actually meant this, it is an argument that is not specific to evolutionary biology, since it can be applied to all of science.

But, as detailed below, Camp is incorrect on both counts regardless. First, though strictly incongruent phylogenies exist, the vast majority of phylogenies are consistent *within error* and with statistical

significance—which is what counts in science. Second, *ad hoc* adjustments are not used liberally—their use is severely constrained by gradualism and by what has been empirically observed. Camp disregards both of these facts.

## A Malign Accusation Based on Misunderstanding of the Scientific Method and Evolutionary Methods

... molecular and morphological phylogenies often are inconsistent, and yet the hypothesis of common descent is not considered falsified. The discordant data are simply accommodated by the theory.

The availability of such *ad hoc* adjustments for resolving incongruities makes the claim of falsifiability an illusion. Any result can be accommodated by the theory by revising one or more of the underlying assumptions.

Biologists cannot "adjust the assumptions" to give any desired result. Camp is making the slanderous claim that biologists unethically manipulate their data to result in a predetermined outcome. Here's a test: if Camp's malign accusation is true, he should be able to adjust the assumptions of a phylogenetic analysis to result in a tree of my choice. Using any molecular data of his choice, Camp should be able to generate a phylogenetic tree with a standard tree-building program (such as PAUP, Phylip, MacClade, etc.) that places chimps closest to fish, humans closest to birds, cows closest to insects, and bacteria closest to marsupials, specifically as shown below:

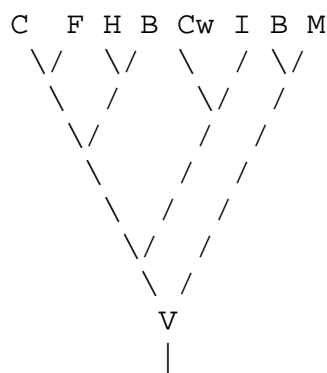

The truth is that Camp will be unable to meet this challenge. All scientists, including biologists, must deal with this annoying thing called "reality." Real data cannot be arbitrarily fit to any model with equal success. Even more importantly, scientists do not uncritically accept *ad hoc* assumptions. Valid assumptions must be reasonable and independently testable.

Mr. Camp has addressed this challenge:

For making the obvious point that assumptions are adjusted to accommodate discordant data, Dr. Theobald falsely accuses me of slandering biologists with the charge that they "*unethically manipulate their data* to result in a predetermined outcome" (emphasis supplied [by Camp]).

This is no false accusation. Unjustified, *ad hoc* manipulation of data is unethical behavior in science, especially if it is used to make data appear to agree with a predetermined outcome. This is precisely what Camp is claiming, and thus he is asserting that biologists unethically manipulate data. If Camp believes biologists do this, he is obligated to provide an example of where researchers have intentionally used *ad*

*hoc*, scientifically unjustified revisions of the underlying assumptions of a phylogenetic analysis in order to make discordant phylogenies appear more congruent. Since Camp is claiming that this is a *general* feature of evolutionary phylogenetic analysis (and not just a rare, exceptional behavior), he should be able to provide *many* examples from throughout the modern peer-reviewed scientific literature (preferably from articles less than 5-10 years old). In the event that Camp is unable to do this, I strongly suggest that he retract his slander.

## Two Wrongs make a Right

Camp, however, has attempted to justify his accusations:

Did anyone accuse Schwabe and Warr of slander ...?

Does it matter? Does Camp believe his statements are justified simply because other people have done the same? Camp's question is an overt use of the "[two wrongs make a right](#)" fallacy (very similar to "[tu quoque](#)").

Did anyone accuse Schwabe and Warr of slander for saying that "Ad hoc arguments can be invented" to explain inconsistent molecular phylogenies in a way consistent with universal common ancestry or for saying that the ability to invoke such arguments robs universal common ancestry of its vulnerability to disproof?

Whether anyone accused them of slander is beside the point. However, Camp claimed *more* than the above. Camp didn't just claim that these *ad hoc* arguments and processes *could be* invoked, he claimed that they *are* invoked by biologists to manipulate the outcomes of their analyses ("the obvious point that assumptions are adjusted to accommodate discordant data"). Camp's allegations go beyond the discussion by Schwabe and Warr. Schwabe and Warr never claimed that "Any result can be accommodated by the theory ...". Camp's question misses the point altogether.

In any event, Schwabe and Warr wrote those comments over eighteen years ago. Mountains of molecular data have been acquired and analyzed since then, and new techniques and technologies have been developed. It is possible that Schwabe and Warr's statements were applicable at the time—but, regardless, they are certainly inapplicable now (see the [discussion of Schwabe and Warr's article](#) below). It is Camp's responsibility to make sure that the sources he quotes are not outdated, and that they are applicable to current science.

Dr. Theobald's challenge to construct a molecular phylogeny to his specification ... misses the point. The point is that his specified molecular phylogeny would be compatible with the bare hypothesis of universal common ancestry.

In other words, Camp admits he is unable to meet the specified challenge. By doing so, Camp concedes that it is untrue that "Any result can be accommodated by the theory by revising one or more of the underlying assumptions". As clearly evidenced by the exchange above, *that* was the point being discussed here—not that any "phylogeny would be compatible with the bare hypothesis of universal common ancestry."

This last point, which Camp urges is *the* point, is irrelevant. It is true only in an extremely trivial sense—if we ignore all other relevant data and the requirements of common descent on our planet. But we cannot ignore this data, since the only way we can test the theory of common descent is with independently acquired evidence. All individual pieces of data, in isolation, are consistent with any theory. However, theories are not tested with single measurements, like a single phylogenetic tree based on one gene. Theories are tested with specific data from specific cases which are compared with each other—this is a basic scientific concept.

The point is that his specified molecular phylogeny would be compatible with the bare hypothesis of universal common ancestry.

Camp's point, though trivially true, is impotent as a criticism of a theory. It is analogously true that a specified value of  $6 \times 10^{-7} \text{ m}^3 \text{ kg}^{-1} \text{ s}^{-2}$  for the universal Newtonian constant of gravitation would be compatible with the "bare" hypothesis of universal gravitation. But the true value is (approximately)  $6.673 \times 10^{-11} \text{ m}^3 \text{ kg}^{-1} \text{ s}^{-2}$ , and the specified hypothetical value is massively inconsistent with all current measurements which have approximated this universal constant. Again, we test universal theories with specific data from independent measurements. This is a fundamental aspect of the scientific method, one that Camp ignores when he argues that my "specified molecular phylogeny would be compatible with the bare hypothesis of universal common ancestry."

The fact remains that the specified phylogeny given above is massively inconsistent with the morphological phylogeny and all known molecular phylogenies, and the specified phylogeny cannot be constructed with any known molecular sequences using current phylogenetic reconstruction programs, regardless of how the assumptions are adjusted. This is exactly what one would predict if common descent is true, and this is precisely why common descent is a falsifiable hypothesis. My specified tree *could* be compatible with common descent in a different world—but in *our* world it is incompatible with common descent, and the real data do not support such a fictitious phylogeny.

### Another logical fallacy: the [argument from authority](#)

In discussing incongruent phylogenies, Camp uses a favorite quote of "scientific" creationists by Christian Schwabe and Gregory Warr (Camp gets Schwabe's name wrong—it is not "Christopher") ([Schwabe and Warr 1984](#)):

Two years earlier, Schwabe and Gregory Warr were equally blunt in their criticism of molecular phylogenies. They saw the field of molecular evolution as being mired in subjectivity driven by an *a priori* commitment to universal common ancestry. They wrote:

We believe that it is possible to draw up a list of basic rules that underlie existing molecular evolutionary models:

1. All theories are monophyletic, meaning that they all start with the *Urgene* and the *Urzelle* which have given rise to all proteins and all species, respectively.
2. Complexity evolves mainly through duplications and mutations in structural and control genes.
3. Genes can mutate or remain stable, migrate laterally from species to species, spread through a population by mechanisms whose operation is not fully understood, evolve coordinately, splice, stay silent, and exist as pseudogenes.
4. Ad hoc arguments can be invented (such as insect vectors or viruses) that can transport a gene into places where no monophyletic logic could otherwise explain its presence.

This liberal spread of rules, each of which can be observed in use by scientists, does not just sound facetious but also, in our opinion, robs monophyletic evolution of its vulnerability to disproof, and thereby its entitlement to the status of a scientific theory. The absolute, explicit and implicit, adherence to all the monophyletic principle and consequently the decision to interpret all observations in the light of this principle is the major cause of incongruities as well as for the invention of all the genetic sidestepping rules cited above. (Schwabe and Warr, 467.)

Camp quotes Schwabe and Warr without providing any hard evidence to back up their claims. Schwabe and Warr wrote these statements nearly twenty years ago, when we had only a tiny fraction of the presently known molecular sequences (in 1984 we had less than two-hundredths of one percent of the number of sequences [known in 2002](#)). Frankly, Schwabe and Warr were wrong. Just because a scientist makes an argument does not mean that his argument is correct. Just because it is published does not make it correct. Publication in peer-reviewed journals is only the first step of scientific peer-review. Just because a scientific argument might have been correct eighteen years ago does not mean it is applicable today. Schwabe and Warr stated their case, but the evidence acquired since has not supported their views. Science is weighed and measured with hard evidence and specific examples. Does Camp give any to support Schwabe and Warr's claims? No.

Let's examine Schwabe and Warr's claims one at a time:

First, it is untrue that "All theories are monophyletic ...". The hypothesis of the universal common ancestry of species is not the same as universal common ancestry of proteins and/or genes. In fact, it is virtually certain that genes and proteins have arisen independently many times throughout evolutionary history. We know of many mechanisms for creating proteins and genes *de novo*. For instance, we have observed the evolution of a completely novel protein in bacteria by mutations which translate a gene in a new reading frame. The resulting protein has no similarity to the initial one ([Ohno 1984](#)).

Second, increases in complexity due to gene duplications and mutations have been observed in the wild and the lab ([Copley 2000](#); [Futuyma 1998](#), p. 274; [Lederberg and Lederberg 1952](#); [Lee et al. 1998](#); [Ohno 1984](#); [Okada et al. 1983](#); [Orser and Lange 1994](#); [Salamone et al. 2002](#)). For example, *Flavobacterium* recently evolved the ability to metabolize the exclusively man-made chemical nylon as its sole carbon source. This ability required the duplication and mutation of genes for three different enzymes ([Negoro et al. 1994](#); [Ohno 1984](#); [Okada et al. 1983](#)). These results have also been duplicated in the lab ([Priyambada et al. 1995](#)). Some of these studies have demonstrated that new enzymes have evolved with increased specificity for their substrates ([Salamone et al. 2002](#)). This is not *ad hoc* nor is it "liberal"—it is factual.

Third, we observe stochastic (random) mutation of genes regularly (which means we expect that often, simply due to chance, genes will not mutate), we regularly observe lateral transfer ([Dowson et al. 1994](#); [Lorenz and Wackernagel 1994](#); [Ochman et al. 2000](#); [Widdowson et al. 2000](#)), we have observed genes spread through populations (yes, even when mechanisms are not well understood) ([Raymond et al. 2001](#)), we find silent genes, we find splicing genes ([Hastings and Krainer 2001](#)), we find pseudogenes ([Mighell et al. 2000](#)). We have observed genes evolve coordinately (concerted evolution) ([Holliday 1964](#); [Meselson and Radding 1975](#); [Szostak et al. 1983](#); [Nagyaki 1983](#); [Hilliker and Chovnick 1981](#); [Petes et al. 1991](#); [Strachan et al. 1985](#); [Lamb and Helmi 1982](#)). Again, none of this is *ad hoc*, nor is it "liberal"; it is factual.

Fourth, countless times we have observed viral vectors insert genes where monophyly could not explain it ([Hindmarsh and Leis 1999](#); [Urnovitz and Murphy 1996](#)). Neither is this *ad hoc*—it is factual.

Finally, Schwabe and Warr state that biologists resorted to "the invention of all the genetic sidestepping



rules cited above" in order to explain their observations. That is preposterous. Biologists did not "invent" these mechanisms; they were empirically discovered both in the wild and in the lab over the past few decades. Now, nearly twenty years after Schwabe and Warr wrote these words, we have delineated these various processes in considerable detail, both mechanistically and structurally at the molecular level.

Camp has replied:

The bare hypothesis of universal common ancestry places no constraint on the operation of these processes. It therefore makes no falsifiable prediction that molecular phylogenies will converge on the standard morphological phylogeny. So, contrary to Dr. Theobald's assertion, it is not that I believe the prediction has been falsified. Rather, I believe the claim of falsifiability is an illusion.

As stated many times over in this reply and in the "29 Evidences," gradualism severely constrains the operation of all evolutionary processes. If we invoke any of the processes that Schwabe and Warr are concerned about, they must be used in a manner consistent with what has been observed. We cannot use any and all rates of mutation—for example, some rates are too high to be reasonable (e.g. greater than an average of  $10^{-6}$  per base per generation in mammals). Contrary to Schwabe and Warr's overstated claims, it is not *ad hoc* to explain observations with mechanisms that have been observed. It is not a "liberal spread of rules." It *is*, however, good scientific practice.

In many, probably most, cases these proposed mechanisms are independently testable. As just one example, horizontal gene transfer by viral insertion into a host genome leaves easily recognizable tell-tale signs in the sequences surrounding the inserted gene. If a gene has been inserted by a viral vector, these tell-tale sequences should be there.

In fact, it would be unjustified and *ad hoc* to be aware of all these observations over the past 50 years of various genetic mechanisms and to argue that they were not important in the past 3.5 billion years of evolutionary history. Camp, Schwabe, and Warr appear to be miffed that biology is complex, and that there are many ways for genes to be transmitted between organisms besides linear inheritance between generations. But this is real science, the real world, real biology—the real world is not simple, and biology is the most complex of sciences. Biological data demand complex explanations. Just because a scientific explanation is complex does not mean it is unfalsifiable. Very clear, unambiguous ways exist to falsify common descent, and demonstrating pervasive, highly incongruent phylogenies is one of them, in spite of these various mechanisms which could be used to explain relatively minor incongruencies. For more explanation, refer to [prediction 3](#).

Furthermore, Schwabe and Warr grossly overstate the importance of known incongruent phylogenies. As addressed in [prediction 3](#) and as illustrated by the Penny and Hendy comment above, incongruent data in phylogenetic analyses are much less problematic than incongruent data in other scientific fields, such as particle physics and gravity. As stated above, in reality the known incongruent trees are a "problem" only in the sense that we biologists wish to attain perfection in our science, and incongruent trees are imperfect.

Camp's fallacious [appeal to authority](#) falls apart upon even cursory inspection. It is yet another example of using outdated (and marginal) science in an attempt to bolster a flawed argument.

## Insufficient Knowledge of Basic Molecular Biology and Genetics

Camp even doubts that correspondence between molecular and morphological phylogenies would be evidence for common descent:

Even if a morphological phylogeny was matched closely by multiple molecular phylogenies, that would not prove that the groups in question descended from a common ancestor. The molecular differences could be linked to the morphological differences for some other reason.

Though Camp's point is valid, it already has been addressed extensively in [Prediction 3](#), [Prediction 17](#), and [Prediction 18](#) of the "29 Evidences." It is relatively simple to find genes or parts of genes (the molecular evidence) that are not functionally linked to morphology.

## Confusion about Evolutionary Theory

Camp goes on to quote Hunter concerning this point:

Hunter illustrates the point this way:

Penny obtained his trees by culling those that were most parsimonious—that is, he selected the trees that showed the least amount of evolutionary change to represent the history of life. The first problem is that Penny's method works perfectly fine on things we know did not come about via Darwinian evolution. For example, Penny's method would also claim that automobiles evolved from one another.

As pointed out above, Hunter is incorrect. Hunter makes the bold claim that "Penny's method would also claim that automobiles evolved from one another" in the absence of any evidence to support that claim. Automobiles might give a most parsimonious tree (though this is not assured), but even if they do, the resulting tree will be bunk. It will not satisfy the mathematical requirements for nested hierarchies, and the reasons are explained in [Prediction 2](#). If Camp and Hunter think otherwise, they should determine a phylogenetic tree of cars, using standard phylogenetic programs, that has statistically significant high values of cladistic hierarchical structure. To really drive the point home, they could derive two trees independently, and then show that they match with statistical significance. If they are correct, they could easily prove their point—but in reality they will be unable to do so.

## A False Analogy

Camp continues with Hunter's quote:

Consider a group of vehicles, beginning with a small economy car and increasing in size to larger cars and to minivans and large-sized vans. One could quantify several aspects of the vehicle designs, such as tire size, steering mechanism, engine size, number of seats and so forth. Presupposing the evolutionary paradigm and searching for parsimonious relationships, we would find that most of the design measures suggest the same relationship. The smaller vehicles have smaller tires, manual steering, smaller engines, and fewer seats. The larger vehicles have larger tires, power steering, larger engines, and more seats. In other words, the groupings suggested by the different design measures (tire size, steering mechanism, engine size, etc.) tend to be similar. But of course, the family of automobiles did not evolve from one another via random mutations. The groupings of the design measures are a natural result of engineering and have nothing to do with Darwinian evolution. How then can Penny's results provide "strong support" for evolution? (Hunter, 40.)

Hunter's example is erroneous for another reason—he has chosen characters that are not independent. This is a big "no-no" in cladistic analysis, and it is a rudimentary issue that is addressed early on in any introductory text on phylogenetic analysis. When using characters of organisms in a cladistic analysis, biologists attempt to use characters that are as functionally and developmentally independent of one another as possible. For instance, the size of an animal is only one character. Of course larger animals will in general have larger bodies, larger legs, and larger heads, just as in Hunter's example larger cars have larger tires, larger engines, etc. To be valid, "largeness" cannot be counted more than once. The very easy solution, which is regularly used by biologists, is to measure the *relative* sizes of different characters. For instance, having a femur/tibia ratio of 3 is a different character from having a femur/tibia ratio of 1/2, regardless of the overall length of the bones. Biologists know that they must normalize for size, and instead they concentrate on structural details. Hunter's example is thus a straw man.

Penny's analysis ([Penny et al. 1982](#)) used five genes, four of which are functionally independent; thus, the result that trees made from several different independent genes match with statistical significance is indeed extremely strong support for common descent. For Hunter's analogy to be valid, he would have to claim that phylogenetic trees made only with cars' steering wheels will match phylogenetic trees made only with cars' tires and trees made only with cars' headlights and trees made only with cars' engines and trees made only with cars' transmissions. Such a claim would be false, since cars with similar tires (e.g. similar width/diameter ratio, manufacturers, tread, color, materials, etc.) do not generally also have similar engines (e.g. similar manufacturer, injection systems, cylinder arrangement, orientation, etc.), or headlights (e.g. similar shape, brightness, manufacturer, bulb type, position, number, etc.), or transmissions, or steering wheels.

Thus, Hunter's [analogy is false](#) for multiple reasons. Hunter's example of how cars' characters can be analyzed to infer a phylogeny is quite different from how real organisms' characters are analyzed by biologists when inferring a phylogeny.

## Insufficient Knowledge of Basic Molecular Biology and Genetics

Camp believes that "it would not be surprising from a creation perspective to find that biochemical similarities increase in relation to other similarities of the creatures being compared," and he quotes anti-evolutionists Duane Gish and Leonard Brand in support:

"We know, for instance, that man is more similar to a chimpanzee than he is to a bat; that he is more similar to either a chimpanzee or a bat than he is to a crocodile or a flea. Man, chimpanzee, and the bat are mammals. The creationist would expect, therefore, that his protein, DNA, and RNA molecules, those macromolecules that are among the most important molecules in metabolism, would be more similar to those of the chimpanzee and to those of the bat than to those of the crocodile or the flea." (Gish, 277-278.)

"Anatomy is not independent of biochemistry. Creatures similar anatomically are likely to be similar physiologically. Those similar in physiology are, in general, likely to be similar in biochemistry, whether they evolved or were designed." (Brand, 156.)

Both are wrong. There is no known biological reason, besides common descent, to suppose that similar morphologies must have similar biochemistry. At first, the statements made by Gish and Brand may seem obviously correct to the layperson, but all of molecular biology refutes this "common sense" correlation. In general, similar DNA and biochemistry give similar morphology and function, but the converse is not true—similar morphology and function is not necessarily the result of similar DNA or biochemistry. The reason is easily understood once explained; many very different DNA sequences or biochemical structures can result in the same functions and the same morphologies. As a very close analogy, consider computer programs.

Netscape works essentially the same on a Macintosh, an IBM, or a Unix machine, but the binary code for each program is quite different. Computer programs that perform the same functions can be written in most any computer language—Basic, Fortran, C, C++, Java, Pascal, etc. and identical programs can be compiled into binary code many different ways. Furthermore, even using the same computer language, there are many different ways to write any specific computer program. In the end, there is no reason to suspect that similar computer programs are written with similar code, based solely on the function of the program. This is the reason why software companies keep their source code secret, but don't care that competitors can use the program—it is essentially impossible to deduce the program code from the function and operation of the software. The same conclusion applies to biological organisms, for very similar reasons.

Leonard Brand is evidently oblivious to this basic conclusion from modern genetics and molecular biology, since Camp quotes him stating:

"An alternate, interventionist hypothesis is that the cytochrome *c* molecules in various groups of organisms are different (and always have been different) for functional reasons. ...If we do not base our conclusions on the *a priori* assumption of megaevolution, all the data really tell us is that the organisms fall into nested groups without any indication of intermediates or overlapping of groups, and without indicating ancestor/descendant relationships. The evidence can be explained by a separate creation for each group of organisms represented in the cytochrome *c* data." (Brand, 158-159.)

Brand's entire argument is predicated upon his first sentence—"An alternate, interventionist hypothesis is that the cytochrome *c* molecules in various groups of organisms are different ... for functional reasons." Brand's hypothesis is uncharacteristically testable, which is fortunate. If we can demonstrate that cytochrome *c* molecules from different organisms are not different for functional reasons, then his argument is moot. In fact, it has been shown that the human cytochrome *c* protein works just fine in yeast (a unicellular organism) that lacks its own native cytochrome *c* gene, even though yeast cytochrome *c* differs from human cytochrome *c* over 40% of the protein. Even the cytochrome *c* genes from tuna, pigeon, horse, *Drosophila* fly, and rat all function well in yeast that lack their own native yeast cytochrome *c*. Furthermore, extensive genetic analysis of cytochrome *c* has demonstrated that the majority of the protein sequence is unnecessary for its function *in vivo* (a point covered in detail in the original version of the "29 Evidences" under [Prediction 17](#)). Thus, Brand's "alternate hypothesis" is false, as is the rest of his argument. The cytochrome *c* gene is not exceptional in this regard—similar results have been found for all other ubiquitous genes tested. Biochemically, the reason for this observation is easily explained. Most of the sequence of a protein, like cytochrome *c*, is used for structural elements. As long as these structural parts of the protein fold into the same structure, the exact sequence is inconsequential. From X-ray crystallographic studies of the atomic structures of proteins, we know that many of the amino acids in any protein are not even used for structure and that many different amino acid sequences can fold into the same structure. Thus, since structure determines function, we fully expect that proteins with very different sequences will give the same function, and that is exactly what we observe. Accordingly, as explained earlier and contrary to Camp's argument, there is no reason to assume (aside from common descent) that similar morphologies and functions are due to similar molecular elements.

### Another [Red Herring](#): Insufficient Knowledge of "Neo-Darwinism"

Camp finds yet another "problem" with the cytochrome *c* data and its implications for common descent:

The cytochrome *c* data on which Dr. Theobald relies present some puzzles from a neo-Darwinian perspective. First, the cytochromes of all the higher organisms (yeasts, plants, insects, fish, amphibians, reptiles, birds, and mammals) exhibit an almost equal degree of sequence divergence from the cytochrome of the bacteria *Rhodospirillum*. In other words, the degree of divergence does not increase as one moves up the scale of evolution but remains essentially uniform. The cytochrome *c* of other organisms, such as yeast and the silkworm moth, likewise exhibits an essentially uniform degree of divergence from organisms as dissimilar as wheat, lamprey, tuna, bullfrog, snapping turtle, penguin, kangaroo, horse, and human.

Though mechanisms of adaptive evolutionary change are not addressed in the "29 Evidences," Camp inserts a [red herring](#) here and shifts the subject by questioning the efficacy of "neo-Darwinism" to explain the degree of divergence observed in the cytochrome *c* sequences of various organisms. Camp's line of argumentation regarding rates is off the point. Common descent states nothing specifically about evolutionary rates, whether they must be fast, slow, variable, or constant, and the most commonly used phylogenetic methods make no rate assumptions. Common descent is, in general, consistent with a large range of evolutionary rates, as long as the rates satisfy the requirement of gradualism. Explaining rates is the specific realm of genetic mechanisms, such as genetic drift, neutral theory, natural selection, gene flow, sexual selection, mutation, etc.

Nevertheless, Camp's discussion of cytochrome *c* rates is flawed and is not based in a working knowledge of the fundamentals of modern genetics or molecular biology. One of the main consequences of the functional redundancy of protein sequences (discussed in preceding paragraphs) is "neutral" evolution. The neutral theory describes the genetic behavior of mutations in protein and DNA sequences that have no, or very slight, selective effects. As mentioned above, about 70% of the cytochrome *c* protein is redundant. Changes in this 70% have virtually no effect upon function, and thus no selective effect—this 70% is selectively "neutral." One of the major predictions of the neutral theory is that the overall rate of evolution in neutral regions (where "evolution" means change in sequence) will be equal to the background rate of mutation. Mutations are largely due to factors that are relatively constant between different organisms, such as chemical and physical events (such as the spontaneous breaking or formation of bonds in DNA) and "errors" in the ubiquitous DNA repair machinery. Thus, neutral theory predicts that neutral rates of evolution should be nearly constant between organisms for functionally equivalent genes. It directly follows that the divergence of cytochrome *c* sequences should be nearly equal between two organisms and their last common ancestor. For example, according to the theory of common descent, bacteria, horses, and insects all share a common ancestor in the remote past. If rates of neutral evolution have been constant since that common ancestor, then the cytochrome *c* proteins of bacteria, horses, insects all should have evolved by the same amount since their last common ancestor. Accordingly, the divergence of cytochrome *c* between bacteria and horses should be nearly the same as the divergence between bacteria and insects. This is the answer to Camp's next question:

Why would the sequence divergence of cytochrome *c* between bacteria and horses be the same as the divergence between bacteria and insects? The presumed evolutionary lineage from the ancestral cell to a modern bacterium differs radically from the presumed evolutionary lineage from the ancestral cell to a modern horse, both of which differ radically from the presumed evolutionary lineage from the ancestral cell to a modern insect. How could a uniform rate of divergence have been maintained through such radically different pathways? According to Michael Denton, a molecular biology researcher, "At present, there is no consensus as to how this curious phenomenon can be explained." ([Denton 1998](#), 291.)

And, as we have shown earlier, Michael Denton knows very little basic evolutionary theory<sup>1</sup>. The most likely

reason why the rate of divergence has been quite uniform in all these "radically different" lineages is that cytochrome *c* does the exact same thing in all these lineages (it transports electrons in the fundamental cellular process of oxidative phosphorylation), and the mutations that do not destroy or change the function of cytochrome *c* are necessarily neutral. A better question is "why would the rate be *nonuniform* in these different lineages?" Contrary to Camp's suggestion, there is a consensus explanation for the cytochrome *c* sequences provided by neutral theory, the one just explicated above in simplified form. Wesley Elsberry gives a more detailed explanation of the cytochrome *c* data in "[Sequences and Common Descent](#)." It is worthy to note here that the consensus explanation for cytochrome *c* sequence divergence does not involve natural selection, but only uses neutral theory, mutation, and purifying selection. To my knowledge, none of these standard genetic theories has been seriously criticized by anti-evolutionists (especially the "scientific" creationists).

An inquisitive person might ask further: "Should the divergence between the cytochrome *c* sequences from different organisms be exactly equivalent?" And the answer is no—mutation, recombination, and sexual reproduction are all stochastic processes (i.e., they have a large probabilistic element to them). We expect, even with exactly equivalent background rates of mutation, that amounts of divergence will be similar, but not equivalent. As with any stochastic process, there is a finite probability that "surprising" things might happen. For instance, whenever we flip 50 quarters, we expect that on average 25 will be heads and 25 will be tails. However, the probability that we will flip *exactly* 25 heads and 25 tails is rather small (~11%). There is a 0.1% chance that we will flip more than twice as many heads than tails. This means that if we repeat our 50-flip experiment 1000 times, we *expect* to flip more than twice as many heads as tails at least once (perhaps more). As Penny *et al.* put it in their article "Testing the Theory of Descent":

"From the proposed stochastic nature of the mechanism of mutation and selection it would be surprising if the trees were identical. Indeed, it would be more devastating to Darwinism if different sets of short sequences always gave identical trees." ([Penny et al. 1991](#))

Thus, given the stochastic nature of genetics, we in fact expect that independently derived trees occasionally will not match exactly and that rates of divergence will vary for the same reasons.

## Disregard for Basic Mathematics: Probability, [Statistics](#) and the [Fallacy of Accident](#)

Camp evidently does not understand the probabilistic nature of genetics, since he is surprised at a small minority of "anomalous" cytochrome *c* sequences:

Moreover, the notion that the rates of divergence remain uniform regardless of evolutionary pathway does not fit all of the cytochrome *c* data. For example, referring to Dr. Theobald's Figure 1 (reproduced above), lampreys, carp, and bullfrogs allegedly shared a common ancestor above the node labeled "vertebra." Since that time, the branch leading to carp and bullfrogs evolved independently of the branch leading to lampreys. If the rates of cytochrome *c* divergence remain uniform regardless of evolutionary pathway, then the degree of sequence variance between the cytochrome *c* of lampreys and carp would be essentially the same as the degree of variance between the cytochrome *c* of lampreys and bullfrogs. That is not the case. The variance between the cytochrome *c* of lampreys and carp is 12%, whereas the variance between lampreys and bullfrogs is 20%. (See matrix in Davis and Kenyon, 37.)

These results are expected if genetics is fundamentally probabilistic instead of deterministic, as it is. Camp states: "If the rates of cytochrome *c* divergence remain uniform regardless of evolutionary pathway, then the degree of sequence variance between the cytochrome *c* of lampreys and carp would be essentially the

same as the degree of variance between the cytochrome *c* of lampreys and bullfrogs." This is incorrect, and displays a lack of understanding of probability and statistics, leading to Camp's commission of a [statistical fallacy](#). Uniform rates are *expected* to give unequal results (see the discussion on mathematics below after the green box). Camp's statements are a nice example of the [fallacy of accident](#) (*Dicto Simpliciter*). Furthermore, Camp is incorrect in his details. I cannot speak for the original citation ([Davis and Kenyon 1993](#)), but the values that Camp gives for the divergences of lamprey, carp, and bullfrog cytochrome *c* are incorrect. The true divergence between the cytochrome *c* of [lampreys](#) and [carp](#) is 19%, and the divergence between lampreys and [bullfrogs](#) is 20%. Camp has since explained that he was using an outdated source (over thirty years old) for these figures, yet he still "stand[s] by" these figures—even though the sequences I have given above were updated in 1981, 1984, and 2000 (this is easily verified simply by clicking the links I have given).

Camp continues with his surprise that some of the cytochrome *c* sequences appear anomalous:

Second, the sequences of cytochrome *c* sometimes differ inversely to the presumed evolutionary proximity of the organisms being compared .... The cytochrome *c* of the rattlesnake varies in 22 places from that of the turtle but only in 14 places from that of a human. ... the cytochrome *c* of the human varies in 12 places from that of a horse but only in 10 places from that of a kangaroo. ... Such discrepancies between traditional phylogenies and those based on cytochrome *c* are well known.

There are many problems with this passage. As stated before, such results are expected if heredity is a stochastic process, as it is. Because genetics is stochastic, the theory of common descent does not predict that phylogenetic trees made with single genes will perfectly match other phylogenetic trees—they must be similar, but not necessarily identical. As already explained in the "29 Evidences":

**"Gene trees are not equivalent to species trees:** from simple Mendelian genetics we know that genes segregate individually, and that throughout time individual genes do not necessarily follow organismic genealogy. An obvious example is the fact that while you may have brown eyes, your child may have the genes for blue eyes—but that does not mean your child is not your descendent, or that your brown-eyed children are more closely related to you than your blue-eyed children. Including multiple genes in the analysis is a solution to this conundrum." ([Avice and Wollenberg 1997](#))

Furthermore, Camp has made a more fundamental error here, indicative of his unfamiliarity with modern evolutionary theory. Camp is directly comparing raw distance data (the number of cytochrome *c* sequence differences) to character data (the morphological phylogenetic data) and expecting them to match, which is improper. In the early days of phylogenetic analysis, researchers used raw distance data to construct phylogenetic trees because distance algorithms are simple and fast (they take little computation time). However, for strong theoretical and empirical reasons, uncorrected distance data is known to be an unreliable basis for phylogenetic analyses (though it is approximately correct under certain conditions). Today, instead of using distance algorithms, evolutionary biologists primarily use more correct (and much more computationally intensive) algorithms, such as maximum parsimony or maximum likelihood, which are based on direct character information. Thus, it is a meaningless criticism to point out that raw molecular distances are sometimes not reflected by character-based phylogenies—that situation is in fact *predicted* by evolutionary theory.

Additionally, Camp incorrectly states that "discrepancies between traditional phylogenies and those based on cytochrome *c* are well known." Camp is referring to out-dated cytochrome *c* analyses which did not include statistical tests of support for the branches in the phylogenies. When only statistically reliable branches are considered, the cytochrome *c* phylogenies are completely congruent with traditional morphological phylogenies—even when the cytochrome *c* phylogeny is approximated with naive, raw

distance-based algorithms.

Apparently, Camp not only misunderstands basic genetics but also has a deep misunderstanding of basic mathematics (probability and statistics), as [he later chides](#) in response:

In other words, evolution expects uniform divergencies [*sic*] of protein sequences, but it also expects nonuniform divergencies if and when they arise. It is an amorphous theory indeed.

There is nothing inconsistent with a uniform rate and nonuniform results. That is basic statistics. As a very simple example, in the above discussion of quarter flipping, the rate of "heads" is exactly 0.5 heads per flip. This rate is *exactly* constant. However, there is nothing unusual (or "amorphous") about flipping five heads in a row, or five tails in a row (corresponding to an average observed rate of one head per flip and zero heads per flip, respectively). Such results are expected if coin flipping is a stochastic process, as it is. We expect these results about 6% of the time. In fact, the outcome of a stochastic process, like coin flipping, radioactive decay, or spontaneous mutation, should approximate a Gaussian bell-shaped curve (also known as a "normal curve"), as explained in any [entry-level probability and statistics text](#).

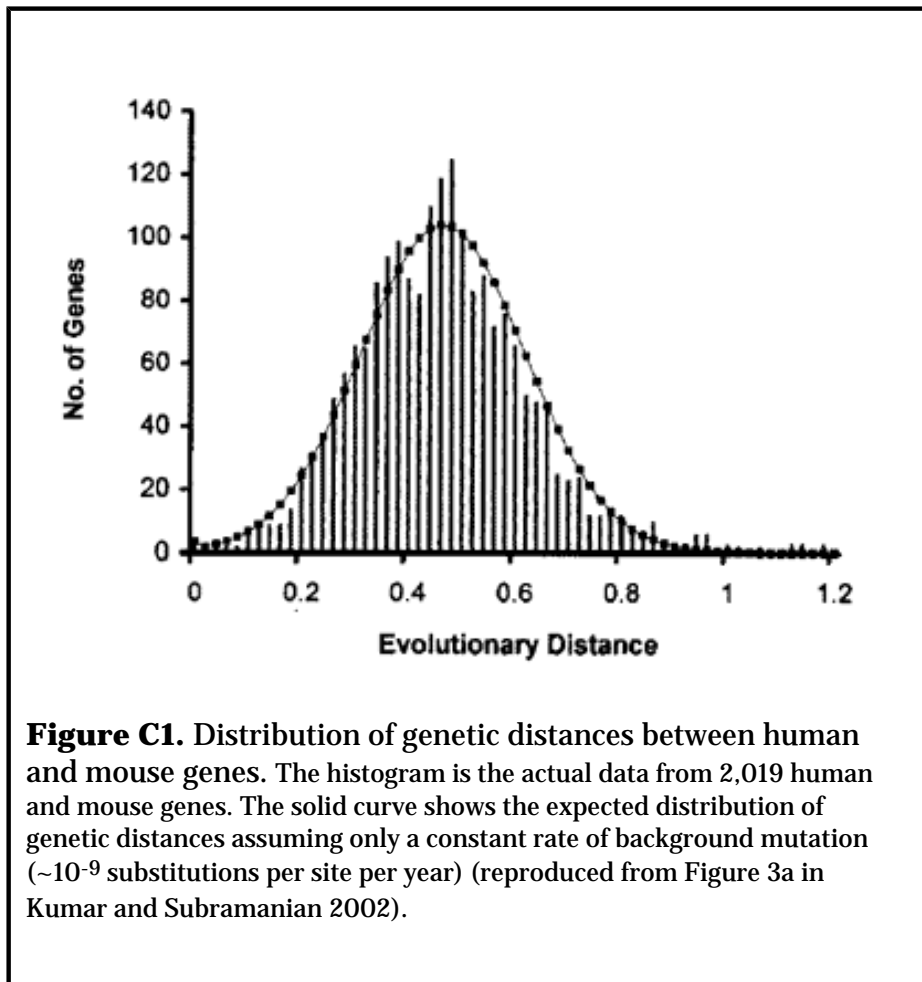

**Figure C1.** Distribution of genetic distances between human and mouse genes. The histogram is the actual data from 2,019 human and mouse genes. The solid curve shows the expected distribution of genetic distances assuming only a constant rate of background mutation ( $\sim 10^{-9}$  substitutions per site per year) (reproduced from Figure 3a in Kumar and Subramanian 2002).

Similarly, if rates of molecular evolution are *exactly* constant, we expect that the genetic divergences between species will be unequal in most cases. In fact, we expect that neutral genetic divergences will be distributed about a Gaussian bell-shaped curve centered on the average rate of molecular evolution. Many species should have more divergence than average (like the rattlesnake cytochrome *c*), and many species should have less divergence than average (like the kangaroo cytochrome *c*). Likewise, we expect that, if background mutation rates are *exactly* constant, genetic divergences between neutral regions of different genes between two species will also be distributed about a bell-shaped curve. In fact, this is precisely what is observed (e.g. see the data for humans and mice in Figure C1 at left; [Kumar and Subramanian 2002](#)). For instance, from basic probability theory, we expect that 15% of genes between humans and mice should evolve over

36% faster than the average constant rate (that is 1.36 times the average rate), over 2% should evolve about 70% faster than the average constant rate, and that 0.5% should evolve over 85% faster than the average rate. And, as the figure shows, this is exactly what we observe in humans and mice. Note, this means that in a comparison of one hundred randomly sampled human and mouse genes, we expect that the most divergent gene will have 0% similarity in neutral regions, while the least divergent gene will have nearly 100% similarity in neutral regions (see the lower left tail of the bell curve in Figure C1). These results are



predicted, based upon simple math, if the average background mutation rate is completely *constant* in both the human and mouse lineages. This fact illustrates nicely why it is premature to base strong evolutionary conclusions on an analysis of only one gene (like the cytochrome *c* gene) or even a few genes; strong conclusions can only be based upon a large sampling of genes.

It is rather presumptuous to label a theory "amorphous", when said theory simply follows basic laws of mathematics.

Even including all the known discrepancies, the cytochrome *c* phylogeny and the traditional morphological phylogeny match to an extremely high degree with extremely high statistical significance ([Penny et al. 1982](#)). And, as expected, including more genes in the analysis increases the correspondence between phylogenetic trees ([Penny et al. 1982](#); [Baldauf et al. 2000](#); [Hedges 1994](#); [Hedges and Poling 1999](#)). In the end, the molecular phylogenetic data, such as the cytochrome *c* data, provide one of the strongest and most irrevocable confirmations of common descent.

## Prediction 4: Possible morphologies of predicted common ancestors

### More Misrepresentation of Evolutionary Theory: Erroneous Logic

Universal common ancestry affirms only that all creatures descended from the same ancestor. There is nothing about that affirmation that requires conformity to the standard phylogenetic tree.

Again, Camp is mistaken. If all organisms are united by descent from a common ancestor, then there is one single true historical phylogeny for all organisms, just like there is one single true historical genealogy for any individual human. It follows that if there is one unique universal phylogeny, then all organisms fit in that phylogeny uniquely. In other words, all organisms, both past (e.g. fossils) and present, must conform to the true phylogeny. Since the standard phylogenetic tree is the best approximation of the true historical phylogeny, we expect that all fossilized animals should conform to the standard phylogenetic tree within the error of our scientific methods. If fossilized animals do not, then there are only two logical possibilities—either our estimation of the true phylogeny is incorrect, or there is no true phylogeny (i.e. common descent is false). This last point leads in to Camp's next mistake:

A phylogenetic tree is merely a diagram that reflects current evolutionary thinking about the relationships of the taxa included. Branches are arranged on the tree on the assumption of evolution and according to perceived similarities in selected traits. The relationships of some branches are viewed more dogmatically than the relationships of others, but none of the branches are set in stone.

No branches are viewed "dogmatically"—some branches have strong support from the data and are very unlikely to be incorrect if common descent is true, while other branches are known with less confidence. Thus, fossilized organisms that contradict the very well-supported branches would be inconsistent with common descent.

### Misunderstanding of the Scientific Method

Camp has replied:

It is self-evident that the bare hypothesis of universal common ancestry affirms only that all creatures descended from the same ancestor. It would be consistent with *all* phylogenies rooted in a single ancestor, and therefore it does not predict *any particular* phylogeny, such as the standard phylogeny. For stating this obvious fact, Dr. Theobald accuses me of misrepresenting evolutionary theory.

Universal common descent is not "consistent with all phylogenies rooted in a single ancestor." Universal common descent predicts that there is only one true phylogeny, not multiple phylogenies. Since it predicts a unique historical phylogeny, the existence of different phylogenies rooted in a common ancestor is incompatible with common descent. Camp is correct that common descent "does not predict *any particular* phylogeny," but that is a moot point. We must examine the data and infer the correct particular tree.

Similarly, Newton's Universal Theory of Gravity affirms that all masses accelerate towards each other proportional to a universal gravitational constant,  $G$ . However, Newton's theory is not consistent with all values of  $G$ , because the theory predicts that there is only one true value of  $G$ , not multiple  $G$ s. Of course Newton's theory does not predict *any particular* value of  $G$ . But that is a moot point. We must examine the data and infer the correct particular value for  $G$ .

Mr. Camp misrepresented evolutionary theory because he said:

Universal common ancestry affirms only that all creatures descended from the same ancestor. There is nothing about that affirmation that requires conformity to the standard phylogenetic tree.

That is false. Universal common ancestry also requires that there is only one historical phylogenetic tree. Thus, independent determinations of the standard phylogenetic tree should conform to each other. The absurdity of Camp's misrepresentation is clear when the analogous statement is made of Newton's Universal Theory of Gravity:

"Universal gravity affirms only that all masses accelerate towards each other. There is nothing about that affirmation that requires conformity to the standard constant  $G$ ."

Of course independent measurements should conform to the standard constant  $G$ . Careful independent measurements of  $G$  should give values that agree reasonably well. If they don't, there is something wrong with the theory. Likewise, careful independent determinations of the standard phylogenetic tree should agree reasonably well. If they don't, there is something wrong with the theory. This is a very basic scientific concept. Camp continues his reply:

The problem is that, since we do not know the true evolutionary history of organisms, we cannot know whether the standard phylogeny is accurate.

Camp is incorrect. In science, there are ways to determine the true evolutionary history (such as cladistics and molecular phylogenetic reconstruction methods), and we can test those results to see whether the standard phylogeny is accurate. That is what the entire "[29 Evidences](#)" is about. This situation is paralleled in all scientific disciplines. We do not know the true gravitational constant,  $G$ , yet, in science, there are ways to determine it. Additionally, we can test our results from these measurements and see whether the consensus value for  $G$  is accurate.

My point was that the inaccuracy exposed by any nonconforming organism could be corrected by adjustments to the phylogeny at a level above the hypothesized universal common ancestor. So, contrary to Dr. Theobald's claim, the hypothesis of universal common ancestry would not be proven false by the discovery of a nonconforming organism. The standard phylogeny simply would be shown to be in need of modification at some level.

This is false. There are some mildly nonconforming organisms that could possibly be incorporated and there are some that cannot. There is no way to modify the standard phylogeny to incorporate a mammal with feathers or a bird with a mammalian head and a placenta. Such organisms will not fit anywhere in the phylogeny. Including a half-mammal/half-bird organism in a cladistic analysis of mammals, reptiles, and birds destroys the hierarchical structure in the resulting cladogram (e.g. as measured by the consistency index, CI, the retention index, RI, the homoplasy index, HI, or the rescaled consistency index, RCI) and greatly reduces the cladogram's resolution (e.g. as measured by the statistical bootstrap support for all the branches in the tree). Normally, including real, allowable intermediates increases the hierarchical structure and resolution of a cladogram (or at least does not affect it much).

Every scientific theory can accommodate incongruent data to some extent, yet every scientific theory also has its limits. For example, Newton's Universal Theory of Gravity predicts that the universal gravitational constant,  $G$ , is constant in space and time.  $G$  should be the same everywhere on the earth and in space. The way we test this is to make multiple independent measurements of  $G$ , at different times, different locations, and using different methods. Newton's theory can (and does) accommodate minor discrepancies (as explained and discussed in [Prediction 3](#)), but there are some values which, if measured, would be too far out to be reconciled. The same is true of universal common descent, and a mammal-bird is an example that is too far out to be reconciled.

## More Misunderstanding of the Scientific Method

Since phylogenies are by nature provisional, the suggestion that the hypothesis of common descent would be falsified by "[a]ny finding of mammal/bird intermediates" is mistaken. Should a strikingly birdlike mammal be discovered, the standard tree simply would be modified to accommodate the new creature, after wrangling over its placement in the schema.

This demonstrates an underlying misconception of the scientific method. *Everything* in science is by nature provisional. However, some things are more "set in stone" than others, and that is where the concept of falsifiability comes in. Even Camp's anti-evolutionist source Walter ReMine understands that science is at once provisional *and* falsifiable:

"The criterion of falsifiability indicates science is tentative. Science never achieves certainty. Science is not rigid and dogmatic ... Because our observations are limited, we can only attain fine shades of *near* certainty. ... While science is tentative, it is not flimsy. Science can carry enough weight that we often speak of a given theory as a fact. ... Science is also tentative about falsifying a theory. It can be difficult to falsify a theory with all the finality we would like. ... By testing ... we attain greater confidence in identifying false hypotheses." ([ReMine 1993](#), p. 34, emphasis in the original)

Though ReMine often misses the mark, these statements capture the essence of testability in science quite well. The standard phylogenetic tree, as currently supported by massive amounts of data, is highly inconsistent with true mammal-bird intermediates. The phylogenetic tree could not be modified to accommodate such creatures—they would not fit anywhere.

## A Glut of Errors: The Fallacy of [Ignoratio Elenchi](#), Multiple [Self-contradictions](#), and Distortion of a Scientific Controversy

Ironically, the inflexibility of this aspect of the standard phylogenetic tree is well-evidenced by Camp's next statements:

The ease with which this precise adjustment could occur was illustrated two decades ago, when "[t]he reality of the 'mammal-bird,' a hypothetical common ancestor of birds and mammals, [was] a contentious issue in modern systematics." (Mike Benton, 18.) Brian Gardiner's cladistic analysis indicated that birds were most closely related to mammals, which relationship was supported by two Cambridge scientists' analysis of molecular data. .... Branches can be rearranged, even between mammals and birds, without skipping a beat in terms of commitment to common ancestry.

Camp's use of the Gardiner controversy misses the point entirely; Camp's reply does not address the issue at hand. It is an example of the [ignoratio elenchi](#) fallacy. Camp was responding to the claim that a mammal-bird is predicted *not* to exist by current evolutionary theory, based upon common descent and the consensus phylogenetic tree. Thus, any finding of a mammal-bird intermediate form in the fossil record would be a falsification. However, the Gardiner controversy does not concern the finding of an intermediate form that is contrary to phylogenetic expectations. Rather, it concerns uncertainty in the consensus phylogenetic tree based upon an analysis of *living* organisms. These are two entirely different issues.

All scientific measurements have some level of uncertainty. This is not a problem in science; it just means we have room to make a more accurate measurement, which, of course, is always desirable. To provide a valid counter-example, Camp needs to provide an instance of where biologists have accepted the finding of an organism that was contrary to very well-supported portions of the consensus phylogeny (branches with very low uncertainty). Camp does not do this—we did not find a mammal-bird intermediate. Instead, he provides an irrelevant, out-dated example of where biologists have had difficulty resolving a branching order in the consensus phylogeny.

However, Camp is, again, self-contradictory—his argument is [inconsistent](#). How can "mammal-birds" at once be contentious and also be accommodated with "ease", "without skipping a beat"? They can't! The Benton article to which Camp refers ([Benton 1984](#)) is wholly devoted to exploring the extremely surprising (and, at the time, quite troubling) idea that the standard phylogenetic tree could be so very, very wrong about birds and mammals. There was nothing "easy" about this possibility—it threatened to shake the very roots of the well-established phylogeny of life. For example, in response to Gardiner's outlandish analysis, zoologist Barry Cox wrote this in a *News and Views* article in *Nature*:

"[Gardiner is] now assaulting even the most fundamental roots of the systems of relationship that the traditional evolutionary morphologists have developed. ... Gardiner has now used cladistic techniques to transform the whole system of tetrapod classification. ... The results are so different ... that a headlong collision is inevitable, for there can be no minor shifting of viewpoints or emphasis that could lead to a reconciliation or synthesis. ... Gardiner's suggestions [are] completely at odds with the palaeontological record ..." ([Cox 1982](#))

Does this sound like biologists accepted this "precise adjustment" with "ease"? Does this sound like these "Branches can be rearranged, even between mammals and birds, without skipping a beat"? In a vain effort to make his point, Camp felt it necessary to grossly misrepresent the true status of the controversy. In his in-depth criticism of Gardiner's analysis, Oxford zoologist T. S. Kemp wrote:

29 + Evidence for Macroevolution

"... many, probably the great majority of vertebrate biologists have dismissed Gardiner's hypothesis as simply outrageous ..." ([Kemp 1988](#), p. 69)

Notwithstanding Camp's unfounded statements, Gardiner's analysis was not incorporated or reconciled, nor were branches rearranged in the consensus phylogeny. In reality, the "contentious issue" was short-lived, as it was soon shown by several independent researchers that Gardiner's cladistic analysis was fundamentally flawed at many levels ([Benton 1985](#); [Benton 1991](#); [Gauthier et al. 1988](#); [Hopson 1991](#); [Kemp 1988](#); [Witmer 1991](#)). Likewise, the supposed corroborating molecular evidence was analyzed incorrectly. At the time (the early '80's), cladistics and molecular phylogenetics were just coming into their own, and the proper techniques were still getting worked out. In fact, improvements are still being made today, as is true of technological innovations in all scientific fields. In the end, all these analyses contributed positively to our knowledge via improved phylogenetic techniques—but they did not radically alter the consensus phylogeny. Quite the opposite, the improved analyses have confirmed that earlier biologists were correct.

Camp has responded:

In the face of this example that contradicts his allegation that a mammal-bird intermediate would falsify universal common ancestry, Dr. Theobald goes on the offensive. ... Dr. Theobald is not thinking clearly. The issue is whether the discovery of a mammal-bird intermediate would falsify universal common ancestry. The fact is that those scientists who concluded that birds were most closely related to mammals (and thus that mammal-bird intermediates existed) remained fully committed to the hypothesis of universal common ancestry. They embraced the mammal-bird link without skipping a beat in terms of commitment to common ancestry.

As stated above, Camp misses the point. As he says, the issue at hand is that a mammal-bird discovery would falsify common descent. The issue is *not* whether the bird-reptile-mammal branching order is uncertain or well-resolved. If some scientists conclude that birds are most closely related to mammals (as Gardiner did), and some other scientists conclude that birds are most closely related to reptiles (as held by the consensus), that is simply an example of uncertainty in branching-order of the consensus phylogeny. It does not address whether the finding of a certain intermediate form (like the mammal-bird) would be inconsistent with highly-resolved regions of the consensus phylogeny. In other words, Camp has not provided an example "that contradicts [the] allegation that a mammal-bird intermediate would falsify universal common ancestry." Camp has side-stepped that issue. Ironically, Camp fully admits this in his response:

The scientific dispute centered on whether mammal-bird intermediates existed (i.e., on whether Gardiner's conclusion was valid), not on whether their existence would require rejection of universal common ancestry. The fact most scientists resisted and ultimately rejected the conclusion that birds were most closely related to mammals is irrelevant to whether the discovery of a mammal-bird intermediate would falsify universal common ancestry.

29 + Evidence for Macroevolution

Precisely. Let's pause here to let the irony of Camp's words soak in:

Dr. Theobald is not thinking clearly.

The issue is whether the discovery of a mammal-bird intermediate would falsify universal common ancestry. ...

[Gardiner's] conclusion that birds were most closely related to mammals is irrelevant to whether the discovery of a mammal-bird intermediate would falsify universal common ancestry. ...

[Gardiner's conclusion] contradicts [Theobald's] allegation that a mammal-bird intermediate would falsify universal common ancestry.

What was the point of offering Gardiner's conclusion if it is irrelevant to the issue at hand? How can Gardiner's conclusion contradict the evolutionary prediction when Camp admits that Gardiner's conclusion is irrelevant to the evolutionary prediction? Is Dr. Theobald really not thinking clearly for pointing out Mr. Camp's extensive habit of self-contradiction?

Nevertheless, Camp's off-point reply has even more flaws. The opinions of a single scientist (or of a few scientists) are not necessarily representative of scientific consensus. One can always find an "expert" who will agree with the most ludicrous ideas (for an enormous amount of examples refer to [QuackWatch](#)). Camp's suggestion that Gardiner's views on mammal-birds and common descent were in-line with scientific consensus is incorrect. Such a claim is another example of Camp's use of the [false appeal to authority](#). Just because Gardiner remained committed to common ancestry does not mean that his actions were logical or scientific. If Camp does not think that Gardiner's views were representative of scientific consensus then Camp's point is still unsound—scientific consensus is what judges the impact of new discoveries and evidence for scientific theories, not renegade scientists. In this case, scientific consensus certainly realized the dangerous consequences of Gardiner's analysis for common descent. That is why T. S. Kemp and Barry Cox wrote what they did, as quoted above. That is why a slew of researchers quickly demonstrated exactly where Gardiner's analysis went wrong and published the results ([Benton 1985](#); [Benton 1991](#); [Gauthier et al. 1988](#); [Hopson 1991](#); [Kemp 1988](#); [Witmer 1991](#)).

Please note that, when considering "scientific consensus" in this debate, it is unnecessary to assume that consensus is correct. The point is not that consensus is somehow always right; the point is that it is invalid to draw general conclusions from an exception. Doing so would be a [fallacy of accident](#). Furthermore, it is illogical to blithely assume that an "expert" correctly judges an issue in his field. Doing so would be a [false appeal to authority](#). For example, it is unfair to maintain that Christianity condones pedophilia simply because some Catholic priests have seemingly reconciled the two. It is invalid to maintain that American Protestantism considers suicide as acceptable behavior simply because of [Jim Jones](#) (an ordained minister in the Christian Churches/Disciples of Christ) and the Peoples Temple. It is incorrect to conclude that modern astrophysics is consistent with an earth-centered universe (geocentrism) simply because [Gerardus D. Bouw](#) (Ph.D. Astronomy, 1973, Case Western Reserve University) maintains that position. It is untrue that the United States Federal judicial system considers the 14th Amendment to the Constitution to be unconstitutional and invalid, even though Judge Lander H. Perez (Louisiana) has submitted [a statement](#) to Congress claiming such. Likewise, it is invalid to conclude that modern evolutionary theory is consistent with mammal-birds, simply because of Brian Gardiner's proposition. (**Note:** there is no other connection implied between any of these examples besides the fact that they are extreme instances of a logical fallacy).

The view promulgated by Gardiner was an extremely marginal one in the scientific community (to my knowledge there are only three scientists on record who supported it, including Gardiner). If the majority of the scientific community had embraced the idea that mammals and birds are closely related, or even

admitted that it was reconcilable with current evolutionary biology, Camp might have a defensible point about the reliability of the consensus phylogeny (which is not the point at hand, in any case). In contrast, the mammal-bird clade was considered "by the great majority of vertebrate biologists" to be "outrageous" (in Kemp's words), and irreconcilable with contemporary evolutionary biology (according to Cox, writing in *Nature's News and Views* column, which is carefully selected and widely regarded to represent scientific consensus on important developments). In spite of the opinions of the few, scientific consensus maintains that mammal-bird intermediates are impossible on our earth. This conclusion is all the stronger in light of the aftermath of the Gardiner controversy.

Recall that Camp stated: "The ease with which this precise adjustment could occur was illustrated two decades ago [by Brian Gardiner's cladistic analysis]." That "precise adjustment," the switch from predicting reptile-bird intermediates to predicting mammal-bird intermediates, occurred with ease for Gardiner. It did not occur with ease for the scientific consensus, which is where scientific theories are weighed, tested, confirmed, and falsified. Thus Camp's point stumbles into self-contradiction: mammal-birds were not simultaneously contentious and also accommodated with "ease," "without skipping a beat." Camp's reply, therefore, is utterly without merit on several levels: it misses the mark (by Camp's own admission) *and* it is logically flawed.

Additionally, calling it a "misguided attack" on his person, Camp has denied that he misrepresented the Gardiner controversy:

The accusation that I misrepresented the controversy is based on the false premise that I claimed Gardiner's theory gained general acceptance in the scientific community and that it did so with ease. I claimed neither.

This is false. Recall Camp's original claim:

Should a strikingly birdlike mammal be discovered, the standard tree simply would be modified to accommodate the new creature, after wrangling over its placement in the schema.

The ease with which this precise adjustment could occur was illustrated two decades ago, when "[t]he reality of the 'mammal-bird,' a hypothetical common ancestor of birds and mammals, [was] a contentious issue in modern systematics."

The only way the *standard* phylogenetic tree would be modified is for scientific consensus to accept the modification. That is why the standard tree is called "standard." The standard tree is by definition the consensus phylogeny. It is not called "Gardiner's phylogenetic tree." Thus, Camp indeed claimed that Gardiner's hypothesis must have gained acceptance in the scientific community; otherwise, the standard tree could not be adjusted or modified, as Camp claims it was. Additionally, Camp claimed that this adjustment to the standard tree occurred with "ease." In spite of Camp's protestations, it is clear that he did indeed misrepresent the scientific controversy, since the standard tree was not modified or adjusted due to the Gardiner controversy.

## Another False Analogy

Of course, the discovery of a strikingly birdlike mammal would not necessarily force a shift in thinking about the relationship of mammals and birds (a placing of their branches next to each other). The birdlike features could be attributed to convergent evolution. Many organisms are believed by evolutionists to have evolved similar traits independently. ... If the mammal's birdlike traits were judged to be the result of convergent evolution, the species would be shown on the phylogenetic tree as a subset or side branch of mammals that was unrelated to birds.

Camp's point is true, but only for limited, trivial cases. Convergence is more likely the less complex the trait. However, for very complex traits, true structural convergence is essentially impossible in the context of common descent and gradualism. For instance, independent evolution of bird flight feathers is widely considered to be out of the realm of possibility. Camp gives an example of possible convergence in an attempt to support his above statements:

(In fact, some experts believe that the birdlike features of dromaeosaurids, the dinosaurs considered by most experts to be the sister group to birds, arose independently rather than by inheritance from the ancestor of birds.)

Though thought unlikely by most paleontologists, such convergence is possible, since the "bird-like" features of dromaeosaurids are in most cases very subtle. The "experts" to which Camp refers here are Alan Feduccia and a few other like-minded biologists. They maintain a minority opinion that dromaeosaurids and birds are both independent descendents of thecodonts (thecodonts are primitive dinosaur-like reptiles). In any case, dromaeosaurids are much more similar to thecodonts than they are to *modern* birds. Thus, Feduccia's suggestion of convergence is not so radical, even though the most parsimonious hypothesis is that birds are the descendents of dromaeosaurids, which in turn are the descendents of thecodonts. In contrast, the claim that a mammal independently evolved bird flight feathers is extremely radical from an evolutionary perspective. Camp's example of possible convergence does nothing to support his erroneous opinion that evolutionary biology could easily accept strikingly bird-like mammals.

## More Distortion of Science

The shift in thinking over the last 30 years about the relationship of dinosaurs and birds is an example of a generally accepted phylogenetic adjustment, albeit at a lower taxonomic level. From the publication of Gerhard Heilmann's *The Origin of Birds* in 1926, it was a matter of textbook orthodoxy that birds were more closely related to thecodonts (an order of reptiles) than to theropods (a suborder of a different order of reptiles). Thus, the discovery in 1964 of the birdlike theropod *Deinonychus* was contrary to phylogenetic expectations. Today, however, the standard phylogeny shows birds more closely related to theropods than to thecodonts.

Camp's claim that "the discovery in 1964 of the birdlike theropod *Deinonychus* was contrary to phylogenetic expectations" is false and does not represent the true status of the scientific situation. As with the Gardiner cladistic analysis, Camp misrepresents the true situation in order to make a fallacious point. Coelurosaurs are theropods, and *Deinonychus* (the "surprise" mentioned by Camp above) is a coelurosaur. Here are Gerhard Heilmann's statements about bird origins from *The Origin of Birds*:

"On turning from the clumsy Predentates to the Coelurosaurs, we meet with quite a different type; ... Hollow bones of very light structure, exceedingly long hind-limbs with strong elongate metatarsals and a "hind-toe," a long, narrow hand, a long tail and a long neck, large orbits and ventral ribs—these are bird-features immediately conspicuous." ([Heilmann 1926](#), p. 165-166)



29+ Evidences for Macroevolution

"... the striking points of similarity between Coelurosaurs and birds pertained to nearly all the parts of the skeleton ... From this it would seem rather obvious that it is amongst the Coelurosaurs that we are to look for the bird ancestor. And yet, this would be too rash, for the very fact that clavicles are wanting would in itself be sufficient to prove that these saurians could not possibly be the ancestors of birds. ... We have therefore reasons to hope that in a group of reptiles closely akin to the Coelurosaurs we shall be able to find an animal wholly without the shortcomings here indicated for a bird ancestor [i.e. the lack of clavicles]." ([Heilmann 1926](#), p. 183-184)

29+ Evidences for Macroevolution

Thus, the discovery of a bird-like theropod, the coelurosaur *Deinonychus*, was clearly anticipated by Heilmann, since Heilmann already considered coelurosaurs and other theropods to be quite bird-like. It's bird-like nature was no surprise. *Deinonychus* is a coelurosaur; many coelurosaurs had been known before 1964<sup>4</sup>. Coelurosaurs were well-known to be strikingly bird-like in many respects, as the Heilmann quotes above demonstrate unequivocally. Thomas. H. Huxley had noted many of the close similarities between theropods (including coelurosaurs) in the mid-19th century ([Huxley 1868](#); [Huxley 1870a](#)), as had many other prominent paleontologists in the early 20th century ([Witmer 1991](#), p. 437-447). Heilmann had reservations about theropods as bird ancestors only because, at the time, theropods were not known to have clavicles (a weak argument, of course, since it is based upon negative evidence—it is now known that clavicles fossilize poorly). Subsequent findings have established that many theropods indeed have clavicles, such as *Segisaurus*, *Velociraptor*, *Euparkeria*, *Ingenia*, *Ornithosuchus*, *Oviraptor*, *Saltoposuchus*, and *Ticinosuchus* ([Barsbold et al. 1990](#); [Bryant and Russel 1993](#)). Some of these dinosaurs even have true furculae (wishbones), a character once thought to be *only* found in birds. Furthermore, it was Thomas H. Huxley who originated the hypothesis of the theropod ancestry of birds all the way back in 1868 ([Huxley 1868](#), p. 74).

29+ Evidences for Macroevolution

The resurrection of the theropod ancestry hypothesis was initiated by J. H. Ostrom in 1973, based upon his re-evaluation of the similarities between *Archaeopteryx* and coelurosaurs ([Ostrom 1973](#)). Ostrom listed 21 specific shared derived characters between *Archaeopteryx* and coelurosaurs as a taxonomic group (not just *Deinonychus*) which had mostly been overlooked throughout the years. The discovery of the bird-like coelurosaur *Deinonychus* in 1964 (first described in Ostrom 1969) was further support for the theropod ancestry hypothesis, but it was not a surprise that "was contrary to phylogenetic expectations"—it was directly in-line with contemporary phylogenetic expectations. In reality, in 1964 the hypothesis that birds were descendents of thecodonts was thought most likely, yet whether theropods were the intermediates between thecodonts and birds was still an open question lacking any firm supporting evidence either for or against ([Bock 1969](#); [Feduccia 1996](#), p. 55-56; [Witmer 1991](#), p. 437-447). Today, with the increased knowledge given by the acquisition of many more fossils, and with the use of rigorously developed cladistic techniques, birds are *still* thought to be the descendents of certain thecodonts (or more correctly, of archosauromorphs, which are a well-defined class of thecodonts—"thecodont" is an outdated, grab-bag term which is no longer used in the modern paleontological literature). Ostrom specifically postulated a "thecodont-coelurosaur-*Archaeopteryx*-Aves phylogeny" ([Ostrom 1973](#)). Birds are descended from "thecodonts" *via* theropods.

29+ Evidences for Macroevolution

Furthermore, Camp claims that, based on Heilmann's analysis, "it was a matter of textbook orthodoxy that birds were more closely related to thecodonts ... than to theropods"—a statement which, strictly, is incorrect. Heilmann only thought that coelurosaurs were not bird *ancestors*, and he thought it likely that thecodonts, as a group, *were* bird ancestors. That does not mean that birds are necessarily more closely related to thecodonts than to theropods (or coelurosaurs). For instance, are you more closely related to your siblings or to your great great great great grandfather? Of course, you are much more closely related to your siblings—yet they are not your ancestors (siblings share half their DNA on average, whereas an individual and her great great great great grandfather share only 1/64<sup>th</sup> of their genes). Likewise, birds could be more closely related to coelurosaurs than thecodonts, while simultaneously being the descendants of thecodonts but not of coelurosaurs. In fact, this is likely what Heilmann thought, as he says:

"We have therefore reasons to hope that in a group of reptiles closely akin to the Coelurosaurs we shall be able to find an animal wholly without the shortcomings here indicated for a bird ancestor. Such a group is possibly the Pseudosuchians [Pseudosuchians are 'thecodonts'] ..." ([Heilmann 1926](#), p. 183-184)

## More Misunderstanding of the Scientific Method, and Another Self-contradiction

Back to Camp's criticism of the prediction of intermediate/transitional organisms:

The assertion that all fossilized animals conform to the standard phylogenetic tree is unprovable, because one can never be sure that all fossilized animals have been discovered.

Camp is clearly correct, but this is certainly not a problem. Camp has pinpointed the very reason why this prediction is falsifiable and thus scientific. The assertion that all fossilized animals conform to the standard phylogenetic tree is unprovable, yes, like all scientific statements—but it is relatively simple to prove this assertion false. Which, by the way, is the essence of falsifiability.

Interestingly, this turns out to be yet another instance where Camp contradicts himself. At the end of his [criticism of prediction 15](#), Camp writes this *non sequitur*:

The suggestion that universal common ancestry would be falsified by "the discovery of a mammal without crossed gastrointestinal and respiratory tracts, or a reptile or mammal without blindspots in its eyes" is incorrect. It is another example of taking what is known not to exist and claiming that evolution predicts it could not exist.

In one instance Camp (correctly) asserts that "one can never be sure that all [organisms] have been discovered," and that, therefore, we can never prove a given prediction of common descent about organisms. Later, when it is more convenient to take the opposite stance, Camp (incorrectly) asserts that a prediction of common descent is not really a prediction, since certain features of organisms are already "known not to exist." How can we know that all mammals and reptiles have crossed gastrointestinal tracts and blindspots if we cannot be sure that we have discovered all mammals and reptiles? We can't. We can never be certain of what exists with incomplete knowledge of the world, and this is precisely why scientific predictions, like the predictions of common descent, are testable, confirmable, and falsifiable.

## Faulty Logic

But more importantly, the premise [that all fossilized animals conform to the standard phylogenetic tree] turns out to be merely a restatement of the claim of nested hierarchy. It adds nothing to the case for common ancestry.

To the contrary, it is not simply a restatement of the nested hierarchy. The "nested hierarchy" statement, given in [prediction 2](#), is that modern organisms should conform to a nested hierarchy if common descent is true. It is tested with modern species by zoologists, botanists, etc. [Prediction 3](#) concerns the morphologies of organisms that existed in the past. It is tested with fossils by paleontologists. In principle, prediction 2

could pass, while prediction 3 could fail, or vice versa. Therefore, they are not the same. Both predictions add to the case for common ancestry, since they are independently tested and confirmed.

... according to the definition of "intermediate" given in the article, dromaeosaurids are *not* reptile-bird intermediates and synapsids are *not* reptile-mammal intermediates. An "intermediate form" is defined as "[a] fossil or modern species that displays characters *definitive* of two or more different taxa" (emphasis supplied). Dromaeosaurids do not display characters that are *definitive* of both reptiles and birds (which is why they are not considered birds), and synapsids do not display characters that are *definitive* of both reptiles and mammals (which is why they are not considered mammals).

Camp is needlessly splitting hairs over terminology, while missing the point. The word "definitive" is not a technical phylogenetic term, and it is not intended to mean "unique" (in cladistic terminology such a "definitive character" would be equivalent to a synapomorphy, but not always an autapomorphy). Dromaeosaurs share many definitive characters with birds, such as a furcula, a retroverted pubis, very long forelimbs, pneumatic (hollow) bones, and a relatively large brain. Before dromaeosaurs were found, birds were the only organisms that had many of these characters (like the furcula). Dromaeosaurs also share many definitive characters with reptiles, such as teeth, free articulating trunk vertebrae, a long tail with free vertebrae (no pygostyle), less than six sacral vertebrae, unfused metacarpals, unfused metatarsals, and gastralia. As listed above, dromaeosaurs share many characters with birds, but they also lack many unique characters that birds have (such as wings)—so they are not birds. Dromaeosaurs are indeed intermediates between birds and reptiles (especially dinosaurs) according to the given definition, and similarly, synapsids are indeed intermediates between mammals and reptiles.

In footnote 13, Camp reiterates this error, plus making a few new ones:

Dromaeosaurids are considered a sister group to birds, meaning they are believed to have shared with birds a most recent common ancestor. They are not believed to have been in the actual lineage of birds. In fact, they possess certain specializations, such as the stiffened tail, that make them ill suited as ancestors. Of course, the presumed common ancestor of birds and dromaeosaurids is thought to have been quite dromaeosaurid-like. As already noted, dromaeosaurids do not qualify as reptile-bird intermediates according to Dr. Theobald's definition.

Camp's concern about "actual lineage" is another misleading red herring and is addressed in the next section. The statement that the stiffened tail makes dromaeosaurids "ill suited" as bird ancestors is ridiculous; birds have extremely stiffened tails (i.e. the pygostyle). Dromaeosaurs indeed have specialized structures that are not likely to be found in bird ancestors, but the stiffened tail itself is not one. The pertinent derived structures are found *on* the tails of Dromaeosaurs. The stiffened tails of Dromaeosaurs have specialized rod-like extensions of the vertebral zygapophyses which are not found in the stiffened tails of birds.

## Misrepresentation of Evolutionary Theory

The assertions that there are "no morphological gaps" in the alleged dinosaur-to-bird transition and that there is an "exquisitely complete series of fossils" for the alleged reptile-to-mammal transition are debatable, to say the least. I have elsewhere tried to point out some of the limitations of those claims (see, "[On the Alleged Dinosaurian Ancestry of Birds](#)" and "[Reappraising the Crown Jewel](#)").

A detailed criticism of the two articles cited above will not be given here. However, I will note that both

criticisms boil down to two main points: (1) that some transitional fossils are more derived than would be required for ancestors, and (2) that some transitional fossils are not in perfect chronological order relative to their cladistic rank. Neither point carries any weight as evidence against common descent, for the simple reason that common descent does not predict either (1) that transitional fossils are ancestors, or (2) that transitional fossils should be in perfect chronological order relative to their cladistic rank. If common descent does not make these claims, then observations that contradict these claims cannot be evidence against common descent.

Point (2), concerning the chronological order of transitional forms, is dealt with in the next section covering [Prediction 5](#). For point (1), as was stated concerning intermediate/transitional forms in the original [prediction 4](#) and [prediction 25](#):

"A subtle, yet important point is that a strict cladistic evolutionary interpretation precludes the possibility of identifying true ancestors; only intermediates or transitionals can be positively identified. (For the purposes of this article, transitionals and intermediates are considered synonymous.) The only incontrovertible evidence for an ancestor/descendant relationship is the observation of a birth; clearly this is normally rather improbable in the fossil record. Intermediates are not necessarily the same as the exact predicted ancestors; in fact, it is rather unlikely that they would be the same. Simply due to probability considerations, the intermediates that we find will most likely not be the true ancestor of any modern species, but will be closely related to the predicted common ancestor. The minor implication concerning fossil intermediates is that the intermediates we do find will likely have additional derived characters besides the primitive characters that identified them as intermediates. Because of these considerations, when a new and important intermediate fossil species is discovered, paleontologists will usually note that the transitional species under study is probably not an ancestor, but rather is an evolutionary 'side-branch.'"

"... given what we know of modern species dynamics and recent extinction rates, we know that the majority of organisms will eventually go extinct ([Diamond 1984a](#); [Diamond 1984b](#); [Wilson 1992](#), ch. 12; [Futuyma 1998](#), pp. 722-723). By extrapolation, the majority of past organisms also have gone extinct. Thus, we should reasonably expect that the predicted common ancestors had many other descendants and relatives that did not leave descendants which survive today. In short, we predict that the majority of fossil species that we find should not be the actual common ancestors of modern species, but rather they should be related organisms that eventually ended in extinction."

To restate—common descent predicts that we may find transitional forms, but transitional forms are not necessarily the same as common ancestors. Presumably, Mr. Camp *does* understand this aspect of modern evolutionary theory but has chosen to misrepresent it, as he has written this [elsewhere](#):

As for the concept of "transitional forms" in general, the term originally meant a creature that was part of the evolutionary transition from species A to species D, so it was necessarily tied to lineage. When evolutionists came up empty on that score, they changed the definition. (This shift was still in process in 1984 when Cracraft wrote, "Part of the confusion apparent \*in the scientific literature\* I suggest, stems from the definition of 'transitional form.'") They now claim as a "transitional form" any creature that is stratigraphically and morphologically between any two taxa, without any regard for whether the particular species represent a lineage. (And they sometimes take creatures that are NOT stratigraphically intermediate and simply assume they must have been.) This is a useful PR strategy for evolutionists because whenever John Q. Public hears "transitional form," he still thinks "lineage."

In other words, Camp understands that common descent, at least in its modern incarnation, does not predict that transitional forms are necessarily common ancestors<sup>2</sup>. However, Camp nevertheless persists in arguing that fossils which are transitional, yet have other derived characters that exclude them as ancestors, are problematic for common descent. He persists in making this misleading argument in the two articles

cited above and in his critique of the "29 Evidences," as well as in [The Overselling of Whale Evolution](#) (all updated as recently as March 11, 2002). Furthermore, Camp mistakenly claims that transitional form originally meant something other than it does now, and that evolutionary biologists were compelled to adjust the definition due to conflicting evidence (a position apparently borrowed from Walter ReMine, e.g. ReMine 1993, p. 294-296, 414-415). Both Camp and ReMine are incorrect; evolutionary biologists have not "changed the definition," nor have they changed the relevant prediction. First, the definition is easily and naturally derived from a phylogenetic tree and, second, Charles Darwin used the modern definition in *The Origin of Species* in 1859 when he first proposed the modern theory of common descent and first introduced phylogenetic trees to the scientific world. The following quotes illustrate this point quite clearly:

... we ought to find in nature, not the actual transitional gradations by which each complex instinct has been acquired—for these could be found only in the lineal ancestors of each species—but we ought to find in the collateral lines of descent some evidence of such gradations; or we ought at least to be able to show that gradations of some kind are possible; and this we certainly can do. ([Darwin 1872](#), p. 320)

Referring to his famous [figure](#), Darwin explained:

It is worth while to reflect for a moment on the character of the new species F14, which is supposed not to have diverged much in character, but to have retained the form of (F), either unaltered or altered only in a slight degree. In this case its affinities to the other fourteen new species will be of a curious and circuitous nature. Being descended from a form that stood between the parent-species (A) and (I), now supposed to be extinct and unknown, it will be in some degree intermediate in character between the two groups descended from these two species. But as these two groups have gone on diverging in character from the type of their parents, the new species (F14) will not be directly intermediate between them, but rather between types of the two groups; and every naturalist will be able to call such cases before his mind. ([Darwin 1872](#), p. 157)

... the diagram throws light on the affinities of extinct beings, which, though generally belonging to the same orders, families, or genera, with those now living, yet are often, in some degree, intermediate in character between existing groups; and we can understand this fact, for the extinct species lived at various remote epochs when the branching lines of descent had diverged less. ([Darwin 1872](#), p. 158)

And,

Supposing B and C to be two species, and a third, A, to be found in an older and underlying bed ... A might be the actual progenitor of B and C, and yet would not necessarily be strictly intermediate between them in all respects. So that we might obtain the parent-species and its several modified descendants from the lower and upper beds of the same formation, and unless we obtained numerous transitional gradations, we should not recognize their blood relationship, and should consequently rank them as distinct species. ([Darwin 1872](#), p. 426)

More relevant evidence is given from the early evolutionary biologist, Thomas Henry Huxley:

Every fossil which takes an intermediate place between forms of life already known, may be said, so far as it is intermediate, to be evidence in favour of evolution, inasmuch as it shows a possible road by which evolution may have taken place. ... Suppose A, B, C to be three forms, while B is intermediate in structure between A and C. Then the doctrine of evolution offers four possible alternatives. A may have become C by way of B; or C may have become A by way of B; or A and C may be independent modifications of B; or A, B, and C may be independent modifications of some unknown D. ... it is always probable that one may not hit upon the exact line of filiation, and, in dealing with fossils, may mistake uncles and nephews for fathers and sons.

I think it necessary to distinguish between [...] classes of intermediate forms, as intercalary types and linear types. When I apply the former term, I merely mean to say that as a matter of fact, the form B, so

named, is intermediate between the others, in the sense in which the *Anoplotherium* is intermediate between the Pigs and the Ruminants—without either affirming, or denying, any direct genetic relation between the three forms involved. When I apply the latter term, on the other hand, I mean to express the opinion that the forms A, B, and C constitute a line of descent, and that B is thus part of the lineage of C. ([Huxley 1870b](#), p. 348-350)

From a popular introductory evolutionary college textbook from the '50s and '60s:

[Intermediate form] always included the idea of a form standing midway between two groups of animals now clearly separate from each other. ([Moody 1953](#), p. 188)

From a modern introductory evolutionary textbook:

**transitional form** A species that exhibits traits common to ancestral and derived groups, especially when the groups are sharply differentiated. ([Freeman and Herron 2001](#), p. 686)

From all these quotes it is evident that early evolutionary biologists did not necessarily equate "intermediate" with "ancestor," and that intermediates do not need to be part of a direct genealogical lineage. This has been clear from the outset. Even in the cases where intermediates are ancestors, Darwin explained that ancestors may have derived characters which were subsequently lost in their descendents. Finally, neither Darwin nor Huxley expected that we should necessarily identify common ancestors, but rather that we should find *intermediates*. These remain the modern evolutionary views (they are now most often couched in cladistic terminology).

Camp complains that "This is a useful PR strategy for evolutionists because whenever John Q. Public hears 'transitional form,' he still thinks 'lineage.'" This gripe is humorous, since "transitional form" is a scientific term, and as such should be defined by scientists as they wish. It's as if Camp were complaining because in Newtonian physics the product of mass and acceleration is called a "force," and that "force" is inappropriate because it sounds too "mystical" to the layperson. Besides, if evolutionary biologists wanted to convey "lineage," the most obvious tact would be to use the term "ancestors" in place of "transitional forms." In spite of Camp's bias, "transitional form" is a perfectly accurate description which has no genealogical connotations.

Consequently, since the terms "intermediate" and "transitional" have been defined since the genesis of evolutionary theory, Mr. Camp has no justification in perpetuating misleading arguments and statements concerning the proper evolutionary definitions of these terms and the relevant predictions of common descent. In doing so, Camp joins the ranks of other creationist anti-evolutionists who knowingly reinforce the widespread, yet incorrect, lay public perception that transitional forms are always common ancestors.

## An Attack on Science

Mr. Camp concludes this section with a veiled attack upon the scientific method itself:

But even if one granted that reptiles evolved into a bird and a mammal, that would not establish that reptiles and all other organisms descended from a common ancestor, which is the proposition being argued. The difference between a bacterium and a reptile, not to mention the other organisms, is considerably greater than the difference between a reptile and a bird or a reptile and a mammal. So the fact a reptile could evolve into a bird or a mammal would not mean that a bacterium could evolve into a reptile and everything else. In fact, granting that reptiles evolved into a bird and a mammal would not even establish that all birds and all mammals descended from a reptile. That would be an assumption.

In this paragraph Camp is criticizing the fundamental scientific practice of extrapolation. Extrapolation underlies all of science; without extrapolation, we could not make any scientific conclusions or predictions. When we sent the *Surveyor 1* spacecraft to the moon in 1966, we *assumed* that Newton's laws of physics operated on the moon, just as they operate on the earth. We *assumed* this even though we had never sent anything to the moon's surface before. And, of course, we were correct—so correct that two years later we entrusted the lives of several men to our assumption. Our assumption was the result of extrapolating from what was known (earth bound physics) to what was unknown (lunar physics). Furthermore, we assume that Newton's laws of physics hold on Neptune and Uranus, even though we have never explored the surfaces of those planets. Likewise, once we have established that certain reptiles have evolved into birds and mammals, we can easily assume that all birds and mammals are descendents of reptiles. We can assume this because it is trivial to conclude that all birds are related by common descent. If a reptile can evolve into a bird then certainly a bird can evolve into another bird. This particular extrapolation should not be controversial for Mr. Camp, since creationists of all stripes generally believe that all birds are modified descendents of an original created bird "kind." Once we have established that something like a bird can evolve from a reptile, we assume that similar things happened with other species and in other lineages.

Camp has replied to this:

According to Dr. Theobald, I am here denying the legitimacy of the principle of extrapolation and thus depriving science of its ability to make any conclusions or predictions. All I am doing is pointing out the difference between what is extrapolated or assumed and what is proved.

Once again we find evidence of Camp's misunderstanding of basic science and the scientific method. Camp errs in claiming that there is a difference between what is extrapolated or assumed and what is proven. In science, nothing can be proven. The reason nothing can be proven is very simple—all scientific conclusions rely upon the fallacy of *affirming the consequent*, and in doing so they rely upon inductive extrapolation. In contrast, a theory conceivably could be shown to be false by using a valid *modus tollens* argument. These issues were the foundation behind Sir Karl Popper's reasoning and his falsifiability criterion for the scientific method. In the end, though, even falsification is flawed, as the premises of any *modus tollens* argument cannot be proven since their validity is also established by affirming the consequent. Mr. Camp surely is aware of this, as he appears to be well-versed in logic. To clarify the import of this scientific dilemma, consider the following example provided by Mr. Camp in his discussion of extrapolation:

Earth-bound physics can be extrapolated to the solar system and universe, but that would not mean the extrapolation was justified. That would have to be demonstrated by evidence (which it was prior to the moon landing in 1969).

Camp thinks that it was valid to assume that the laws of physics worked on the moon like they do on the

earth, because he thinks this particular extrapolation was proven prior to the 1969 moon landing. The logic goes something like this:

**Premise 1:** If laws of earth-bound physics are obeyed on the moon, then spacecraft which we send there will behave as we predict, based upon earth-bound physics.

**Premise 2:** Our spacecraft behaved as we predicted (such as the *Surveyor 1* spacecraft in 1966).

**Conclusion:** The laws of earth-bound physics are obeyed on the moon.

This argument is a classic example of affirming the consequent, a fallacy of propositional logic. In the above argument, we have extrapolated from one event (the *Surveyor 1* spacecraft) to a generality. For some reason, Camp thinks an extrapolation here is "demonstrated by the evidence," even though it is logically fallacious, but he does not allow extrapolation in biology. As explained earlier, in his attack on extrapolation Camp is attacking all of science. In fact, if we deny science the right to extrapolation, we deprive science of the ability to make predictions and conclusions. If we allow extrapolation, we simply cannot claim that scientific conclusions are proven. This does not mean, however, that science cannot approximate reality and make useful predictions and explanations, as it obviously does. In practice, scientists use probability and statistics to quantify the degree of support that evidence provides for a given hypothesis or theory. In sum, since nothing can be proven in science, and all is extrapolation, Camp is not "pointing out the difference between what is extrapolated or assumed and what is proved"—he is attacking the scientific practice of extrapolation, plain and simple. Mr. Camp's philosophical and theological bias allows him to ignore scientific extrapolation unless the conclusions conflict with his preconceptions.

Camp ends here on a strange note by adhering to only birds, reptiles, and mammals. The prediction being criticized was the general prediction from common descent of transitional forms. The bird-reptile transitional forms (such as *Archaeopteryx* and the various wingless feathered dinosaurs recently found in China) that Camp mentions are only a small minority of the [numerous transitional forms](#) found in the fossil record. All of these intermediates linking the grand swath of living and extinct organisms certainly do offer strong support for universal common descent when taken as a whole.

## Prediction 5: Chronological order of predicted common ancestors

### More Misrepresentation of Evolutionary Theory, and Another Self-contradiction

Camp correctly restates the prediction and then begins his criticism in earnest:

There is nothing about the hypothesis of universal common ancestry that requires organisms to have descended in the pattern depicted in the standard phylogeny. ... A phylogeny is simply a depiction of the order in which evolutionists believe taxa arose, not the order in which they were *required* to arise.

Camp has it backwards. Cladistic phylogenies are built based upon morphology. The order in which organisms arose is a deduction from a phylogeny. Thus, whenever we have a well-supported phylogeny, the order in which organisms are required to have arisen is firmly predicted, based upon that phylogeny. Camp directly contradicts himself in the next paragraph:

... ancestral taxa must have existed before any taxa that descended from them ...



Yes, and that is exactly why a phylogeny predicts the relative order in which taxa have arisen during evolution.

Camp has responded to this:

... one cannot predict from universal common ancestry that intermediates will appear as reflected in the standard phylogeny. That prediction must be rooted elsewhere than in the bare hypothesis of universal common ancestry. ... the expectation that organisms will appear in a particular order is *not* a deduction from universal common ancestry; it arises from a phylogeny. Thus, the hypothesis of universal common ancestry would not be proven false by the discovery of a fossil "intermediate" out of the order reflected in the standard phylogeny.

Here Camp's words are still confused and again misrepresent evolutionary theory. The standard phylogeny is the rigorous scientific depiction of universal common descent; they are one and the same. The reasoning is very simple: common descent is the hypothesis that all living species are genealogically related, and everything that is related has a genealogy. A genealogy of species is a phylogeny, and thus the genealogy of all species is the standard phylogeny. Since organisms must have arisen in the order depicted in a phylogeny, the order of evolution of all organisms is a deduction from common descent.

To reveal the incorrectness of Camp's statements, let's construct an analogous comment with Newton's Theory of Gravity (the universal Gravitational Inverse Square Law, GISL) replacing universal common ancestry:

... one cannot predict from universal GISL that masses will accelerate as reflected by the standard gravitational constant, **G**. That prediction must be rooted elsewhere than in the bare hypothesis of universal GISL. ... the expectation that masses will accelerate at a given rate is *not* a deduction from universal GISL; it arises from a gravitational constant. Thus, the hypothesis of universal GISL would not be proven false by the discovery of a mass which does not accelerate as expected according to the standard gravitational constant, **G**.

I hope it is clear that these statements are incorrect, as are the analogous ones that Camp makes about common descent. The reason that these comments are incorrect is because the standard gravitational constant **G** is the rigorous scientific quantification of universal GISL, just like the standard phylogeny is for common descent. If universal GISL is true, then all masses must accelerate at rates consistent with the universal constant **G**. If universal common descent is true, then all organisms must have arisen in the order depicted in the standard phylogeny.

Failing to grasp the point, Dr. Theobald accuses me of contradicting myself in the very next paragraph because I acknowledged the truism that ancestors must have existed before descendants.

Camp contradicts himself because he fails to grasp the truism that the standard phylogeny is equivalent to a specification of universal common descent on our planet (just like the universal gravitational constant **G** specifies the universal GISL in our universe).

## Insufficient Knowledge of Evolutionary Methods and Data

... it remains possible for a proponent of common descent to assert that select taxa appear in the fossil record contrary to the order in which they came into existence.

Witness the fact dromaeosaurids, which are offered by Dr. Theobald as "reptile-bird intermediates," first appear in the fossil record some 25 million years *after* the first fossil bird. ... Rather than disqualifying dromaeosaurids in Dr. Theobald's eyes as "reptile-bird intermediates," which he argues must appear in the order suggested by the standard phylogeny, it is simply assumed that dromaeosaurids lived tens of millions of years before there is any evidence of their existence. (The ambiguity of "*general* chronological order" prevents such nonconformities from falsifying the claim.)

The issue of "out-of-order" fossils has been addressed thoroughly in the updated version of [Prediction 5](#). If we consider the entire geological record of the earth, an uncertainty of 25 million years is equivalent to less than 0.6% relative uncertainty. If we consider only the fossil record of life, an error of 25 million years is equivalent to, at most, a 1% relative uncertainty. Both values are overall quite minor. In fact, we know empirically that the error inherent in the fossil record is worse than that. For example, the coelacanth last appeared in the fossil record 80 million years ago, yet it is alive today. Thus, arguing that certain fossils are "out-of-order" by merely 25 million years is a meaningless argument. It carries no scientific weight. In contrast, the finding that these fossils were "out-of-order" by, say, 150 million years would be much more significant, since the resolution of the fossil record is known to be better than that in most cases (especially throughout the Mesozoic and Cenozoic).

The assertion that "The ambiguity of '*general* chronological order' prevents such nonconformities from falsifying the claim [of prediction 5]" is incorrect. There are very well defined scientific statistical methods for determining whether the chronological order of fossils *generally* matches the order required by the consensus phylogenies. If stratigraphy generally matches phylogeny, then there is a positive correlation between stratigraphic position and phylogenetic rank. It is also possible to demonstrate that there is either no correlation between phylogeny and stratigraphy or that there is an anti-correlation. Demonstrating a statistically significant negative correlation between the standard phylogenetic tree and the fossil sequence would be a firm falsification of this basic macroevolutionary prediction. However, as detailed in [Prediction 5](#), there is overall a statistically significant positive correlation between stratigraphy and phylogeny, which is a strong confirmation of the prediction that "fossilized intermediates should appear in the correct general chronological order based on the standard phylogenetic tree."

The fact synapsids appear before dromaeosaurids hardly constitutes proof (confirms the "prediction") that "fossilized intermediates" appear in the general chronological order indicated in the standard phylogeny. They are only two data points.

True, but they were only given as representative examples, not as sole "proof." Furthermore, these two data points are very well-supported phylogenetically, and their temporal separation (~150 million years) is outside the likely error of the fossil record.

But more importantly, one must bear in mind that Figure 1 is of necessity a simplified and fragmentary phylogeny. The picture changes significantly when the scope of inquiry is broadened. According to one Harvard-trained paleontologist:

"[T]he correspondence between phylogeny and the fossil record is not as strong as it might first seem. When the order of all kingdoms, phyla and classes is compared with the most reasonable phylogenies, over 95 percent of all the lines are not consistent with the order in the fossil record." ([Wise 1994](#), p. 225-226.)

Again, Camp is quite mistaken. The quote from Kurt Wise is supported by opinion only, not by facts or by any published analysis of the data. In reality, the more diverse the taxa that are included in the analysis, the stronger the correlation between stratigraphy and phylogeny, and the more statistically significant it becomes. For many relevant references, see the ["Confirmation" of Prediction 5](#).

Camp has replied:

That is true, but it does not alter the fact Wise performed the analysis and reached the quoted conclusion.

Actually, we have no evidence that Wise performed the analysis. We can take Wise's word for it (and in fact I do)<sup>3</sup>, but most importantly we have no reason to believe that Wise's analysis is correct. That is exactly why science is fundamentally dependent upon peer review—other scientists need to evaluate the data and double check the methods and conclusions of any scientific analysis. It is quite common for even respectable, intelligent, well-meaning scientists to make mistakes. As might be expected, anti-evolutionists (especially the "scientific" creationists) are not fond of peer review.

Dr. Theobald then gives the impression that Wise's conclusion is contradicted by a dozen studies referenced in the "Confirmation" section of Prediction 5 of his revised article. That, however, is incorrect.

In fact, that "impression" is quite correct, and it is based on numerous published analyses from many different researchers.

None of those studies duplicated Wise's analysis. That is, they did not compare the order of all kingdoms, phyla, and classes with their most reasonable phylogenies. Rather, they took multiple cladograms of a narrower range of taxa and compared them with the fossil record for those groups.

These statements are ludicrous. Wise's analysis has never been published; how does Camp know what Wise did?

Moreover, the results are not as impressive as one might think from Dr. Theobald's comments.

Camp then goes on to list specific data from some of the referenced published papers which demonstrate a highly significant correlation between stratigraphic order and phylogeny. Camp erroneously believes it is problematic that a minority of single cladograms show no correlation with stratigraphic data. If this were true of scientific theories, then the fact that smoking causes cancer would be falsified, since many people who smoke do not develop cancer. But science does not work that way. All physical processes involve stochastic (chance) elements, and scientific results are evaluated statistically. Camp's argument is another clear example of the [fallacy of accident](#) (or more correctly, "[converse accident](#)"). Camp conveniently omits the statistical analyses which demonstrate exactly how impressive the total data really are.

For instance, Michael Benton and Rebecca Hitchin published a recent, greatly expanded, and detailed stratigraphic analysis of 384 published cladograms of various multicellular organisms ([Benton and Hitchin 1997](#)). Using the three measures of congruence between the fossil record and phylogeny mentioned by Camp (the RCI, GER, and SCI), these researchers observed values "skewed so far from a normal distribution [i.e. randomness] that they provide evidence for strong congruence of the two datasets [fossils and cladograms]." The results were overall extremely statistically significant ( $P < 0.0005$ ), a result that *is* extremely impressive. With his blatant anti-science bias, Camp might subjectively feel that these "results are not as impressive as one might think," however, scientists use statistics as an objective measure of "impressiveness." High statistical significance is considered as strongly confirming the predictions of a theory ( $P \leq 0.01$ ); the results from Benton and Hitchin's analyses are *at least* 500 times more impressive than that. As the authors comment in their discussion:

"... the RCI and SCI metrics showed impressive left-skewing; the majority of cladograms tested show good congruence between cladistic and stratigraphic information. Cladists and stratigraphers may breathe easy: the cladistic method appears, on the whole, to be finding phylogenies that may be close to the true phylogeny of life, and the sequence of fossils in the rocks is not misleading. ... it would be hard to explain why the independent evidence of the stratigraphic occurrence of fossils and the patterns of cladograms should show *such striking levels of congruence* if the fossil record and the cladistic method were hopelessly misleading." ([Benton and Hitchin 1997](#), p. 889, emphasis added)

In sum, the chronological appearance of fossils in the fossil record generally matches very well with the order required by the consensus phylogeny of the major taxa. Although it was possible to falsify this prediction, this prediction has been confirmed and offers strong support for the theory of common descent.

## Conclusion

Camp's criticism of Section 1 of the "29 Evidences" was nearly twice as long as Section 1 itself; my response to Camp's criticism of Section 1 is nearly four times as long as the original Section 1. The remaining four sections will have to wait. None are difficult to rebut, except for the time and effort required. As stated at the beginning of this rebuttal, Camp's critique is error-ridden in various ways, and is plagued by this "host of intellectual sins" (in Camp's own words):

1. Red herrings
2. Self-contradictions
3. Equivocation
4. Two wrongs make a right
5. Fallacies of accident
6. Ignoratio elenchi
7. Naive theological assumptions
8. Insufficient knowledge of basic biology, molecular biology, biochemistry and genetics
9. Misunderstanding of the scientific method
10. Straw man arguments

11. Forwarding of untestable competing "hypotheses"
12. Mischaracterization of evolutionary theory
13. Quoting out of context
14. Fallacies of accent
15. Distortion of scientific controversies
16. Arguments from authority
17. False analogies

Each of these resurfaces in the remaining four sections of the critique. As demonstrated in even this limited rebuttal, Camp's criticism of the "29 Evidences" is without scientific merit.

Camp concludes his article with this claim for his motivation:

Dr. Theobald [is] certain that the evidence of nature points ineluctably to the conclusion of universal common ancestry. I once shared that opinion of history, but having shifted my point of view, I find that the same evidence points to something entirely different.

What is this "something entirely different"? From the second sentence of Camp's critique:

I believe the founding members of these groups [of organisms] were created miraculously and separately by God.

There is good reason to be skeptical of the claim that Camp was led to this conclusion by the "evidence of nature." Camp has written elsewhere that his rejection of evolutionary theory is not based in scientific evidence, but rather it is a result of a religious conviction to a literal interpretation of Genesis.

"[Scripture] cannot contain errors or falsehoods. Everything in it must be true ... " ([Camp 1999](#), p. 20-21)

"I sympathize with the desire to present Scripture as compatible with current scientific orthodoxy, but the exegetical objections to this theory strike me as insurmountable. ... All such interpretations strike me as attempts to conform the Bible to conclusions drawn elsewhere ... If the meaning of Scripture is distorted to fit scientific opinion, its authority has been relinquished. ... This is not to deny that it is difficult at present to harmonize some of the scientific data with a recent-creation interpretation of Scripture." ([Camp 1999](#), p. 42-43)

It is also difficult to reconcile Camp's statement that "I find that the same evidence points to something entirely different" with "it is difficult at present to harmonize some of the scientific data with a recent-creation interpretation of Scripture."

Perhaps, then, even Mr. Camp agrees that his critique is not based in scientific evidence?

*Job hath spoken without knowledge, and his words were without wisdom.—Job 34:35*

*Then the Lord answered Job out of the whirlwind, and said,*

*"Who is this that darkeneth counsel by words without knowledge? Gird up now thy loins like a man; for I will demand of thee, and answer thou me. Where wast thou when I laid the foundations of the earth? declare, if thou hast understanding."*

*"Hast thou entered into the springs of the sea? or hast thou walked in the search of the depth?"*

*"Hast thou perceived the breadth of the earth? declare if thou knowest it all."*

*"Where is the way where light dwelleth? and as for darkness, where is the place thereof,"*

*"Hast thou entered into the treasures of the snow? or hast thou seen the treasures of the hail,"*

*"Hath the rain a father? or who hath begotten the drops of dew? Out of whose womb came the ice? and the hoary frost of heaven, who hath gendered it?"*

—from Job 38

*The Lord by wisdom hath founded the earth; by understanding hath he established the heavens.—Proverbs 3:19*

*The fear of the Lord is the beginning of knowledge: but fools despise wisdom and instruction.—Proverbs 1:7*

*Wisdom is the principal thing; therefore get wisdom: and with all thy getting get understanding.—Proverbs 3:7*



[Contents](#)

## Footnotes

1. As an aside, Camp has misplaced the above Denton quote. To be fair, Denton made that remark in response to the controversial "molecular clock" hypothesis, which is related though distinctly different from the observation of equal molecular divergences between species. From his later comments, Camp evidently does not understand this difference. The molecular clock hypothesis is the idea that rates of evolution are constant throughout time. Rates could be extremely variable yet result in equal genetic distance between two species serendipitously. Conversely, rates could be very constant in specific lineages, yet result in unequal genetic distances (if the rates are unequal between lineages). Regardless, Denton is still confused on the subject, as he uncritically assumes that absolute background mutation rates in yeast should be "100,000 times greater than in a tree or a mammal ..." ([Denton 1998](#), p. 291-292). This would only be true if DNA replication errors were the primary source of mutations. However, there is currently little data supporting this directly. Recent studies have indicated that other sources of mutation are more important ([Huttely et al. 2000](#); [Bohossian et al. 2000](#); [Kumar and Subramanian 2002](#)). All else equal, we expect that absolute background mutation rates should be equivalent between species, and that is roughly what is observed. Even if DNA replication errors are the primary cause of mutations, from the most basic

conclusions of neutral theory there are other reasons (beyond the scope of this rebuttal) for why rates of protein evolution should be relatively equal between organisms with very short or very long generation times (see [Ohta 1993](#) and references therein—this article gives the consensus explanation which Denton claims does not exist, and it demonstrates that the evidence supports this explanation). [Back](#)

2. Camp is incorrect here in his assessment that stratigraphy bears upon whether an organism is considered a transitional form or not. A transitional form is defined purely in terms of morphology, regardless of age. Additionally, Camp's quote of Cracraft is horribly out-of-context due to the ellipses. The quote originally read—"Part of the confusion apparent in the scientific literature and the religious writings of the creationists, I suggest, stems from the definition of 'transitional form.'" ([Cracraft 1984](#)) [Back](#)

3. Kurt Wise is extremely honest, and, of all the "scientific creationists," Wise bears both the best credentials and the best of reputations. Wise has admittedly relinquished all pretense of scientific objectivity, as he does not trust science to accurately represent reality. Wise has written:

"Although there are scientific reasons for accepting a young earth, I am a young-age creationist because that is my understanding of the Scripture. As I shared with my professors years ago when I was in college, if all the evidence in the universe turns against creationism, I would be the first to admit it, but I would still be a creationist because that is what the Word of God seems to indicate. Here I must stand." ([Wise 2001](#)).

As such, Wise holds certain "hypotheses" (including a very narrow and theologically questionable interpretation of Scripture) which he will believe even though all evidence indicates otherwise. Such statements, ostensibly coming from a scientist practicing the scientific method which holds all conclusions as provisional and open to further testing, certainly indicates that there is no reason to trust the scientific validity of any unpublished, unreviewed "analyses" performed by this man. In light of the fact that Mr. Camp is fond of quoting "creation scientists" like Duane Gish, Lee Spetner, Walter ReMine, and "John Woodmorappe," another honest statement by young-earth creationist Wise is pertinent here:

"Most creation science is garbage" (quoted in an interview in [Hitt 1996](#)).

Wise has expounded:

"This gets me in a lot of trouble with a lot of creationists, ... the material that's out there is—uh, I'll hold back and be nice—garbage. It's really atrocious" (quoted by [Mays Shark 1998](#)).

[Back](#)

4. Such as *Ornithomimus antiquus*, found in 1865, *O. velox*, 1890, *O. edmontonicus*, 1933, *O. lonzeensis*, 1903, *O. sedens*, 1892, *Paronychodon lacustris*, 1876, *Ornitholestes hermanni*, 1903, *Proceratosaurus bradleyi*, 1910, *Compsognathus longipes*, 1859, *Struthiomimus altus*, 1902, *Thecocoelurus daviesi*, 1888, *Chirostenotes pergracilis*, 1924, *Oviraptor philoceratops*, 1924, *Therizinosaurus cheloniformis*, 1954, *Alectrosaurus olseni*, 1933, *Albertosaurus sarcophagus*, 1905, *A. grandis*, 1890, *Tarbosaurus efremovi*, 1955 *T. bataar*, 1955, *Tyrannosaurus rex*, 1905, *Velociraptor mongoliensis*, 1924, *Dromaeosaurus albertensis*, 1922, *D. cristatus*, 1876, *D. explanatus*, 1876, and *D. gracilis*, 1888. [Back](#)

6. Camp has replied to my explanation about the constraint of gradualism in considering valid evolutionary mechanisms. He claims that the case was overstated due to the use of a particular word, "any". However, this criticism is erroneous and is an example of the fallacy of accent:

... one must recall that Dr. Theobald claimed in his article to prove universal common ancestry "independent of *any* explanatory mechanism." ... The point, however, is that the requirement of gradualness restricts the universe of mechanisms. So if one's argument for common ancestry assumes gradualism, one is not arguing for common ancestry "independent of *any* explanatory mechanism." Rather, one is making an argument for common ancestry that is dependent on gradual explanatory mechanisms. ... Rather than acknowledge that he overstated his case, Dr. Theobald ignores his contradictory statements and blames me for not knowing that he really meant to restrict the explanatory mechanisms to gradual ones. If that was his intent, he should not have claimed that he was arguing for common ancestry "independent of any explanatory mechanism." He was trying to have his cake and eat it too.

The statement that "the evidence and the conclusion [of common descent] are independent of any explanatory mechanism" was made on the very last page of the article. By placing it there, I assumed that the reader had in fact read the introduction and the rest of the article. It is clear Mr. Camp himself wrongly assumes that "any" is equivalent to "all." Saying that common descent is independent of any explanatory mechanism is not the same as saying that common descent is independent of *all possible* explanatory mechanisms (see definitions 1a, 2a, 2c, and 3b for [any](#) in the Merriam-Webster Dictionary, or the first two definitions of [any](#) in the Cambridge International Dictionary of English). Camp misleadingly places emphasis upon the word "any." I did not emphasize the word "any" as Camp did when he quoted my statement; this is an example of the [fallacy of accent](#). Even if one incorrectly interprets the somewhat ambiguous word "any" as "all," all mechanisms are not valid *explanatory* mechanisms. The gradualistic restriction of explanatory mechanisms is and was explicitly made numerous times throughout the "29 Evidences" (e.g. all of [Part 3](#) is devoted to the direct consequences of this concept—note the quote at the heading). [Back](#)

## References

- Awise, J. C., and Wollenberg, K. (1997) "Phylogenetics and the origin of species." PNAS 94: 7748-7755.
- Baldauf, S. L., Roger, A. J., Wenk-Siefert, I., and Doolittle, W. F. (2000) "A kingdom-level phylogeny of eukaryotes based on combined protein data." Science 290: 972-7.
- Barsbold, R., Maryanska, T., and Osmolska, H. (1990) "Oviraptorosauria". In **The Dinosauria**. Weishampel, D. B., Dodson, P. and Osmolska, H. (eds.), p. 249-258. University of California Press, Berkeley.
- Benton, M. (1984) "Is a dog more like a lizard or a chicken?" New Scientist, 16 August p. 18-19.
- Benton, M. J. (1985) "Classification and phylogeny of the diapsid reptiles." Zool. J. Linn. Soc. 84:97-164.
- Benton, M. J. (1991) "Amniote Phylogeny." In **Origins of the Higher Groups of Tetrapods**. Eds. H. Schultze and L. Trueb. Cornell Univ. Press, Ithaca. p. 317-330.
- Benton, M. J., and Hitchin, R. (1997) "Congruence between phylogenetic and stratigraphic data on the history of life." Proc. R. Soc. Lond. B. 264: 885-890.
- Bock, W. J. (1969) "The origin and radiation of birds." Annals of the New York Academy of Sciences. 167: 147-155.
- Bohossian, H. B., Skaletsky, H., Page, D. C. (2000) "Unexpectedly similar rates of nucleotide substitution found in male and female hominids." Nature. 406: 622-5.
- Brand, L. (1997) **Faith, Reason, and Earth History: A Paradigm of Earth and Biological Origins by Intelligent Design** Berrien Springs, MI: Andrews University Press.



- Brenner, S. (1957) "On the impossibility of all overlapping triplet codes in information transfer from nucleic acid to proteins." PNAS 43:687-694.
- Bryant, H. N., and Russell, A. P. (1993) "The occurrence of clavicles within dinosauria: implications for the homology of the avian furcula and the utility of negative evidence." *Journal of Vertebrate Paleontology* 13:171-184.
- Camp, A. L. (1999) **Feet Firmly Planted: A Theological Handbook for the Church of Christ**. Ktisis Pub., Tempe, Arizona.
- Copley, S. C. (2000) "Evolution of a metabolic pathway for degradation of a toxic xenobiotic: the patchwork approach." *TIBS* 25: 261-265.
- Cox, B. (1982) "New branches for old roots." *Nature* 298:321.
- Cracraft, J. (1984) "The significance of the data of systematics and paleontology for the evolution-creation controversy." in **Evolutionists Confront Creationists**. Eds. Awbrey, F. T. and Thwaites, W. M. Proceedings of the 63rd annual meeting of the Pacific Division, American Association for the Advancement of Science, pp. 189-205.
- Crick, F. H. C., Barnett, L., Brenner, S., and Watts-Tobin, R. J. (1961) "General nature of the genetic code for proteins." *Nature* 192:1227-1232.
- Darwin, C. (1872) **On the Origin of Species**. New York, Random House.
- Davis, P., and Kenyon, D. (eds) (1993) **Of Pandas and People**. Second edition. Houghton Publishing Co., Dallas.
- Denton, M. (1986) **Evolution: A Theory in Crisis**. Adler and Adler, Bethesda, MD.
- Denton, M. (1998) **Nature's Destiny**. Free Press, New York.
- Diamond, J. M. (1984a) "Historic extinctions: A Rosetta Stone for understanding pre-historic extinctions." **Quaternary Extinctions: A Prehistoric Revolution**. P. S. Martin and R. G. Klein. Tucson, University of Arizona Press: 824-862.
- Diamond, J. M. (1984b) "Normal" extinctions of isolated populations. *Extinctions*. M. Nitecki. Chicago, University of Chicago Press: 191-246.
- Dowson, C. G., Coffey, T. J., Spratt, B. G. (1994) "Origin and molecular epidemiology of penicillin-binding-protein-mediated resistance to beta-lactam antibiotics." *Trends Microbiol* 2: 361-66.
- Feduccia, A. (1996) **The Origin and Evolution of Birds**. New Haven, Yale University Press.
- Freeman, S., and Herron, J. C. (2001) **Evolutionary Analysis**. Second edition. Prentice Hall, New Jersey.
- Futuyma, D. (1998) **Evolutionary Biology**. Third edition. Sunderland, Mass., Sinauer Associates.
- Gauthier, J. A., Kluge, A. G., and Rowe, T. (1988) "Amniote phylogeny and the importance of fossils." *Cladistics* 4:105-209.
- Hastings, M. L., and Krainer, A. R. (2001) "Pre-mRNA splicing in the new millennium." *Curr Opin Cell Biol* 13: 302-309.
- Hedges, S. B. (1994) "Molecular evidence for the origin of birds." PNAS 91: 2621-2624.
- Hedges, S. B., and Poling, L. L. (1999) "A molecular phylogeny of reptiles." *Science* 283: 998-1001.
- Heilmann, G. (1926) **The Origins of Birds**. London, Witherby.

- Hilliker, A. J. and Chovnick, A. (1981) "Further observations on intragenic recombination in *Drosophila melanogaster*." *Genet. Res.* 38: 281-296.
- Hindmarsh, P., and Leis, J. (1999) "Retroviral DNA Integration." *Microbiology and Molecular Biology Reviews* 63: 836-843.
- Hinegardner, T. T., and Engelberg, J. (1963) "Rationale for a Universal Genetic Code." *Science* 142: 1083-1085.
- Hitt, J. (1996) "[On Earth as it is in heaven.](#)" *Harper's Magazine* 292(1758): 51-60
- Holliday, R. (1964) "A mechanism for gene conversion in fungi." *Genet. Res.* 5: 282-304.
- Hopson, J. A. (1991) "Systematics of nonmammalian Synapsida and implications for patterns of evolution in synapsids" In **Origins of the Higher Groups of Tetrapods**. Eds H. Schultze and L. Trueb. Cornell Univ. Press, Ithaca. p. 635-693.
- Hunter, C. G. (2001) **Darwin's God: Evolution and the Problem of Evil**. Grand Rapids, MI, Brazos Press.
- Huttley, G. A., Jakobsen, I. B., Wilson, S. R., Eastal, S. (2000) "How important is DNA replication for mutagenesis?" *Mol Biol Evol.* 17: 929-37.
- Huxley, T. H. (1868) "On the animals which are most nearly intermediate between the birds and reptiles." *Annals and Magazine of Natural History* 2:66-75.
- Huxley, T. H. (1870a) "Further Evidence of the Affinity between the Dinosaurian Reptiles and Birds." *Quarterly Journal of the Geological Society.* 26: 12-31.
- Huxley, T. H. (1870b) "Palaeontology and the Doctrine of Evolution." In **Collected Essays**. v. 8, "Discourses, biological and geological." Greenwood Press, New York.
- Judson, H. F. (1996) **The Eighth Day of Creation: Makers of the Revolution in Biology**. Expanded edition. Cold Spring Harbor Press.
- Kemp, T. S. (1988) "Haemothermia or Archosauria? The interrelationships of mammals, birds and crocodiles." *Zool. J. Linn. Soc.* 92:67-104.
- Kumar, S., and Subramanian, S. (2002) "Mutation rates in mammalian genomes." *Proc Natl Acad Sci* 99: 803-808.
- Lamb, B. C. and Helmi, S. (1982) "The extent to which gene conversion can change allele frequencies in populations." *Genet. Res.* 39: 199-217.
- Lederberg, J., and Lederberg, E. M. (1952) "Replica plating and indirect selection of bacterial mutants." *Journal of Bacteriology* 63: 399-406.
- Lee, S. G., B. D. Yoon, *et al.* (1998) "Isolation of a novel pentachlorophenol-degrading bacterium, *Pseudomonas* sp. Bu34." *Journal of Applied Microbiology* 85: 1-8.
- Lorenz, M. G. and Wackernagel, W. (1994) "Bacterial gene transfer by natural genetic transformation in the environment." *Microbiol. Rev.* 58: 563-602.
- Mayshark, J. F. (1998) "[Monkey Trouble: Shaking the Family Tree.](#)" *MetroPulse*. Knoxville, TN. Issue 1, Vol 50. May 18.
- Meselson, M. and Radding, C. (1975) "A general model for genetic recombination." *PNAS* 72: 358-361.
- Mighell, A. J., Smith N. R., Robinson P. A., and Markham, A. F. (2000) "Vertebrate pseudogenes." *FEBS Lett.* 468: 109-114.
- Moody, P. A. (1953) **Introduction to Evolution**. First edition. New York: Harper and Row.

- Moody, P. A. (1962) **Introduction to Evolution**. Second edition. New York: Harper and Row.
- Nagylaki, T. (1983) "Evolution of a large population under gene conversion." PNAS 80: 5941-5945.
- Negoro, S., Kato, K., Fujiyama, K., Okada, H. (1994) "The nylon oligomer biodegradation system of *Flavobacterium* and *Pseudomonas*." Biodegradation. 5: 185-194.
- Ochman, H., Lawrence, J. G., Groisman, E. A. (2000) "Lateral gene transfer and the nature of bacterial innovation." Nature 405: 299-304.
- Ohno, S. (1984) "Birth of a unique enzyme from an alternative reading frame of the preexisted, internally repetitious coding sequence." PNAS 81: 2421-5.
- Ohta, T. (1993) "An examination of the generation-time effect on molecular evolution." PNAS 90: 10676-10680.
- Okada, H., Negoro, S., Kimura, H., and Nakamura, S. (1983) "Evolutionary adaptation of plasmid-encoded enzymes for degrading nylon oligomers." Nature 306: 203-6.
- Orser, C. S., and Lange, C. C. (1994) "Molecular analysis of pentachlorophenol degradation." Biodegradation 5: 277-288.
- Osborn, H. F. (1918) **The Origin and Evolution of Life**. Charles Scribner's Sons, New York.
- Ostertag, E. M., and Kazazian, H. H. (2001) "Biology of mammalian L1 retrotransposons." Annu. Rev. Genet. 35: 501-538.
- Ostrom, J. H. (1969) "Osteology of *Deinonychus antirrhopus*, an unusual theropod from the Lower Cretaceous of Montana." Bulletin—Peabody Museum of Natural History. 30: 1-165.
- Ostrom, J. H. (1973) "The ancestry of birds." Nature 242: 136.
- Penny, D., and Hendy, M. D. (1986) "Estimating the reliability of phylogenetic trees." Mol. Biol. Evol. 3: 403-417.
- Penny, D., Foulds, L. R., and Hendy, M. D. (1982) "Testing the theory of evolution by comparing phylogenetic trees constructed from five different protein sequences." Nature 297: 197-200.
- Penny, D., Hendy, M. D., and Steel, M. A. (1991) "Testing the theory of descent." In **Phylogenetic Analysis of DNA Sequences**, eds. Miyamoto, M. and Cracraft, J., New York: Oxford University Press. pp. 155-183.
- Petes, T. D., Malone, R. E., and Symington, L. S. (1991) "Recombination in yeast." pp. 407-521. In: **The Molecular and Cellular Biology of the Yeast *Saccharomyces*: Genome Dynamics, Protein Synthesis, and Energetics**. Vol I. Cold Spring Harbor Laboratory Press, Cold Spring Harbor, New York.
- Prijambada, I. D., Negoro, S., Yomo, T., Urabe, I. (1995) "Emergence of nylon oligomer degradation enzymes in *Pseudomonas aeruginosa* PAO through experimental evolution." Appl Environ Microbiol. 61: 2020-2022.
- Raymond, M., Berticat, C., Weill, M., Pasteur, N., Chevillon, C. (2001) "Insecticide resistance in the mosquito *Culex pipiens*: what have we learned about adaptation?" Genetica 112-113:287-296.
- ReMine, W. (1993) **The Biotic Message**. St. Paul Science, St. Paul, MN.
- Ridley, M. (1985) **The Problems of Evolution**. Oxford University Press, New York.
- Ridley, M. (1993) **Evolution**. Boston: Blackwell Scientific.
- Salamone, P. R., Kavakli, I. H., Slattery, C. J., Okita, T. W. (2002) "Directed molecular evolution of ADP-glucose pyrophosphorylase." Proc Natl Acad Sci 99: 1070-1075.

Schwabe, Christian, and Warr, Gregory W. (1984) "A Polyphyletic View of Evolution: The Genetic Potential Hypothesis." *Perspectives in Biology and Medicine* 27: 465-485.

Strachan, T. Webb, D. and Dover, G. A. (1985) "Transitional stages of molecular drive in multiple-copy DNA families in *Drosophila*." *EMBO J.* 4: 1701-1708.

Szostak, J. W., Orr-Weaver, T. L., Rothstein, R. J. and Stahl, F. W. (1983) "The double-strand-break repair model for recombination." *Cell* 33: 25-35.

Urnovitz, H. B., and Murphy, W. H. (1996) "Human endogenous retroviruses: nature, occurrence, and clinical implications in human disease." *Clin Microbiol Rev* 9: 72-99.

Widdowson, C. A., Adrian, P. V., Klugman, K. P. (2000) "Acquisition of chloramphenicol resistance by the linearization and integration of the entire staphylococcal plasmid pC194 into the chromosome of *Streptococcus pneumoniae*." *Antimicrob Agents Chemother* 44: 393-95.

Wilson, E. O. (1992) **The Diversity of Life**. Cambridge, MA, Harvard University Press.

Wise, K. P. (1994) "The Origin of Life's Major Groups." In **The Creation Hypothesis**, pp. 211-234. Moreland, J. P. ed., InterVarsity Press, Downers Grove, IL.

Wise, K. P. (2001) "Kurt P. Wise—Geology." in **In Six Days: Why 50 Scientists Choose to Believe in Creation**. pp. 351-355. J. F. Ashton, Ed. Green Forest, AR: Master Book, Inc.

Witmer, L. M. (1991) "Perspectives on Avian origins." In **Origins of the Higher Groups of Tetrapods: Controversy and Consensus**. p. 427-466. Eds. Schultze, H. P. and L. Trueb. Ithaca, Comstock Publishing Associates.

[Full references](#)

[Glossary](#)



Home	Browse	Search	Feedback	Links
The FAQ		Must-Read Files		Index
Evolution		Creationism		Age of the Earth
Flood Geology		Catastrophism		Debates

[Home Page](#) | [Browse](#) | [Search](#) | [Feedback](#) | [Links](#)



[The FAQ](#) | [Must-Read Files](#) | [Index](#) | [Creationism](#) | [Evolution](#) | [Age of the Earth](#) | [Flood Geology](#) | [Catastrophism](#) | [Debates](#)

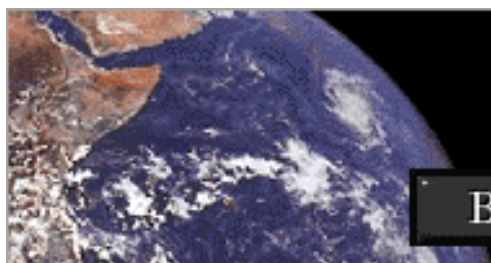

# The Talk.Origins Archive

Exploring the Creation/Evolution Controversy

[Browse](#)[Search](#)[Feedback](#)[Links](#)

## Charles Darwin on "Gradualism"

From the end of Chapter 7 of *The Origin of Species*

---



[Contents](#)

**M**r. Mivart is further inclined to believe, and some naturalists agree with him, that new species manifest themselves "with suddenness and by modifications appearing at once." For instance, he supposes that the differences between the extinct three-toed Hipparion and the horse arose suddenly. He thinks it difficult to believe that the wing of a bird "was developed in any other way than by a comparatively sudden modification of a marked and important kind;" and apparently he would extend the same view to the wings of bats and pterodactyles. This conclusion, which implies great breaks or discontinuity in the series, appears to me improbable in the highest degree.

Everyone who believes in slow and gradual evolution, will of course admit that **specific changes may have been as abrupt and as great as any single variation which we meet with under nature**, or even under domestication. But as species are more variable when domesticated or cultivated than under their natural conditions, it is not probable that such great and abrupt variations have often occurred under nature, as are known occasionally to arise under domestication. Of these latter variations several may be attributed to reversion; and the characters which thus reappear were, it is probable, in many cases at first gained in a gradual manner. A still greater number must be called monstrosities, such as six-fingered men, porcupine men, Ancon sheep, Niata cattle, etc.; and as they are widely different in character from natural species, they throw very little light on our subject. Excluding such cases of abrupt variations, the few which remain would at best constitute, if found in a state of nature, doubtful species, closely related to their parental types.

My reasons for doubting whether natural species have changed as abruptly as have occasionally domestic races, and for entirely disbelieving that they have changed in the wonderful manner indicated by Mr. Mivart, are as follows. According to our experience, abrupt and strongly marked variations occur in our domesticated productions, singly and at rather long intervals of time. If such occurred under nature, they would be liable, as formerly explained, to be lost by accidental causes of destruction and by subsequent intercrossing; and so it is known to be under domestication, unless abrupt variations of this kind are specially preserved and separated by the care of man. Hence, in order that a new species should suddenly appear in the manner supposed by Mr. Mivart, it is almost necessary to believe, in opposition to all analogy, that several wonderfully changed individuals appeared simultaneously within the same district. This difficulty, as in the case of unconscious selection by man, is avoided on the theory of gradual evolution, through the preservation of a large number of individuals, which varied more or less in any favourable direction, and of the destruction of a large number which varied in an opposite manner.

That many species have been evolved in an extremely gradual manner, there can hardly be a doubt. The species and even the genera of many large natural families are so closely allied together that it is difficult to distinguish not a few of them. On every continent, in proceeding from north to south, from lowland to upland, etc., we meet with a host of closely related or representative species; as we likewise do on certain distinct continents, which we have reason to believe were formerly connected. But in making these and the following remarks, I am compelled to allude to subjects hereafter to be discussed. Look at the many outlying islands round a continent, and see how many of their inhabitants can be raised only to the rank of doubtful species. So it is if we look to past times, and compare the species which have just passed away with those still living within the same areas; or if we compare the fossil species embedded in the sub-stages of the same geological formation. It is indeed manifest that multitudes of species are related in the closest manner to other species that still exist, or have lately existed; and it will hardly be maintained that such species have been developed in an abrupt or sudden manner. Nor should it be forgotten, when we look to the special parts of allied species, instead of to distinct species, that numerous and wonderfully fine gradations can be traced, connecting together widely different structures.

Many large groups of facts are intelligible only on the principle that species have been evolved by very small steps. For instance, the fact that the species included in the larger genera are more closely related to each other, and present a greater number of varieties than do the species in the smaller genera. The former are also grouped in little clusters, like varieties round species; and they present other analogies with varieties, as was shown in our second chapter. On this same principle we can understand how it is that specific characters are more variable than generic characters; and how the parts which are developed in an extraordinary degree or manner are more variable than other parts of the same species. Many analogous facts, all pointing in the same direction, could be added.

Although very many species have almost certainly been produced by steps not greater than those separating fine varieties; yet it may be maintained that some have been developed in a different and abrupt manner. Such an admission, however, ought not to be made without strong evidence being assigned. The vague and in some respects false analogies, as they have been shown to be by Mr. Chauncey Wright, which have been advanced in favour of this view, such as the sudden crystallisation of inorganic substances, or the falling of a faceted spheroid from one facet to another, hardly deserve consideration. One class of facts, however, namely, the sudden appearance of new and distinct forms of life in our geological formations supports at first sight the belief in abrupt development. But the value of this evidence depends entirely on the perfection of the geological record, in relation to periods remote in the history of the world. If the record is as fragmentary as many geologists strenuously assert, there is nothing strange in new forms appearing as if suddenly developed.

Unless we admit transformations as prodigious as those advocated by Mr. Mivart, such as the sudden development of the wings of birds or bats, or the sudden conversion of a Hipparion into a horse, hardly any light is thrown by the belief in abrupt modifications on the deficiency of connecting links in our geological formations. But against the belief in such abrupt changes, embryology enters a strong protest. It is notorious that the wings of birds and bats, and the legs of horses or other quadrupeds, are undistinguishable at an early embryonic period, and that they become differentiated by insensibly fine steps. Embryological resemblances of all kinds can be accounted for, as we shall hereafter see, by the progenitors of our existing species having varied after early youth, and having transmitted their newly-acquired characters to their offspring, at a corresponding age. The embryo is thus left almost unaffected, and serves as a record of the past condition of the species. Hence it is that existing species during the early stages of their development so often resemble ancient and extinct forms belonging to the same class. On this view of the meaning of embryological resemblances, and indeed on any view, it is incredible that an animal should have undergone such momentous and abrupt transformations as those above indicated, and yet should not bear even a trace in its embryonic condition of any sudden modification, every detail in its structure being developed by insensibly fine steps.

He who believes that some ancient form was transformed suddenly through an internal force or tendency into, for instance, one furnished with wings, will be almost compelled to assume, in opposition to all analogy, that many individuals varied simultaneously. It cannot be denied that such abrupt and great changes of structure are widely different from those which most species apparently have undergone. He will further be compelled to believe that many structures beautifully adapted to all the other parts of the same creature and to the surrounding conditions, have been suddenly produced; and of such complex and wonderful co-adaptations, he will not be able to assign a shadow of an explanation. He will be forced to admit that these great and sudden transformations have left no trace of their action on the embryo. To admit all this is, as it seems to me, to enter into the realms of miracle, and to leave those of science.

Darwin, C. (1872) **The Origin of Species**. Sixth Edition. The Modern Library, New York.



[Contents](#)

Home	Browse	Search	Feedback	Links
The FAQ	Must-Read Files		Index	
Evolution	Creationism		Age of the Earth	
Flood Geology	Catastrophism		Debates	

[Home Page](#) | [Browse](#) | [Search](#) | [Feedback](#) | [Links](#)

[The FAQ](#) | [Must-Read Files](#) | [Index](#) | [Creationism](#) | [Evolution](#) | [Age of the Earth](#) | [Flood Geology](#) | [Catastrophism](#) | [Debates](#)

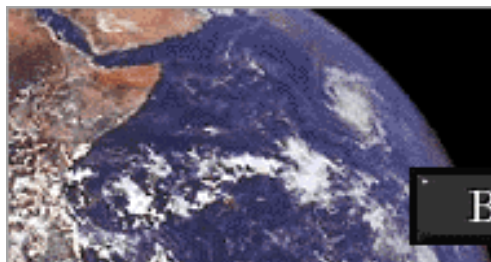

[Browse](#)
[Search](#)
[Feedback](#)
[Links](#)

## 29+ Evidences for Macroevolution

### "Evidences"?

Copyright © 1999-2003 by [Douglas Theobald, Ph.D.](#)



[Contents](#)

"The only people who use 'evidences' (plural) are creationists or people who have spent far too much time reading their literature! 'Evidences' is a term from Christian apologetics ..."

Eugenie C. Scott, *Executive Director for the National Center for Science Education.*

"Now, this bill was of course drafted by a theologian or somebody versed in apologetics. There's an amusing bit of 'evidence' on that subject in the very language of the bill. The bill keeps using - the *act* keeps using the term 'evidences' in the plural. We lawyers never speak of 'evidences' in the plural; we speak of 'evidence' - the singular. I got nagged by it and I looked it up the other day. And of course the only dictionary reference to 'evidences' is to Christian apologetics - the 'evidences' for Christianity."

Jay Topkis, *speaking of Louisiana's "Creationism Act" during [Edwards v. Aguillard](#) before the U. S. Supreme Court, Dec 10, 1986.*

I've caught an enormous amount of flack for the title of this FAQ. Many a reader has reminded me that "evidences" is only used in ecclesiastical contexts. True, the majority of references using the term "evidences" are religious apologies, as evidenced by a [simple Google search for "evidences"](#). Others importune that "evidences" is not even

a valid English term, as "evidence" is already a plural noun (formally known as a *mass noun* or a *non-count noun*). Originally, the title of this FAQ was diffidently christened "Proofs of Macroevolution" - something used just to be a *tad* provocative, since science really cannot prove anything in the mathematical or logical sense of "prove." I was strongly urged to remove the overstated "Proofs" (and I agreed it should be changed), so I decided to insert "evidences" as an inside joke for all who realize how common that bit of language is in creation/evolution debates. Personally, I thought it was pretty funny. It also lends a nice eccentric air to the title, giving it some name recognition. Who would remember "The Scientific Evidence for Common Descent" or some other insipid appellation? Recently, I've had some fun investigating the historical usage of the word "evidences," and I am surprised to report that it is not at all limited to Christian apologetics. It appears to be somewhat of an archaic usage, but was not and is not confined to theological discourse. In an effort to contribute even more verbiage to this logomachy, I have compiled a listing of authors, writers, politicians, documents, historians, scientists, etc. that have employed this particular etymon. My locution might be peculiar, but I have distinguished company.

The word "evidences," as a plural of the noun "evidence," is currently used secularly at least [seven times](#) in the latest edition of the Columbia Encyclopedia (Sixth Edition 2001), mostly in a legal context.

The infamous term is also sparingly used in modern scientific literature. For example, a [search for "evidences" in the text of all online HighWire journals](#) gets over 1000 hits. The title of an article, of course, is the part most closely inspected by journal editors. A more limited [search of only the titles](#) of scientific articles in the PubMed database returns over 250 documents. For example, the term "evidences," as a conspicuous member of a paper's title, has made it past the editors of the [Proceedings of the National Academy of Sciences](#), [Science](#), the [Journal of the American Chemical Society](#), the [Journal of Molecular Evolution](#), [Cancer](#), the [Journal of Biological Chemistry](#), [Physical Review Letters](#), [Biochimica and Biophysica Acta](#), [Nucleic Acids Research](#), [Virology](#), [Genetics](#), and the [Federation of European Biochemical Societies Letters](#), some of the world's most prestigious scientific journals (note that a small minority of these articles use "evidences" as a transitive verb). For comparison, a title-word [search at PubMed for the co-opted word "proofs"](#) returns only 25 articles (many of which are used in a mathematical context, and don't really count).

---

Thomas Henry Huxley (1825-1895).

**Evidences as to Man's Place in Nature.** (1863)

"Palaeontology and the Doctrine of Evolution." (1870)



creature in resemblance of the mother, the affection of nobleness which nature shows above her breeding, and many other **evidences** proclaim her with all certainty to be the king's daughter."

---

Emily Post (1873-1960).

**Etiquette.** (1922).

*Chapter XXXVIII. The Growth of Good Taste in America*

"GOOD taste or bad is revealed in everything we are, do, have. Our speech, manners, dress, and household goods--and even our friends--are **evidences** of the propriety of our taste, and all these have been the subject of this book."

*Chapter XXV. The Country House and Its Hospitality.*

"Besides these actually destructive shortcomings, there are **evidences** of bad upbringing in many modern youths whose lack of consideration is scarcely less annoying."

---

Ralph Waldo Emerson (1803-1882), U. S. essayist, poet.

**English Traits.** (1856)

*ch. 10.*

"In America there is a touch of shame when a man exhibits the **evidences** of large property, as if after all it needed apology. "

"The Over-Soul" Essays,

*First Series* (1841, repr. 1847).

"The moment the doctrine of the immortality is separately taught, man is already fallen. In the flowing of love, in the adoration of humility, there is no question of continuance. No inspired man ever asks this question, or condescends to these **evidences**. For the soul is true to itself, and the man in whom it is shed abroad cannot wander from the present, which is infinite, to a future which would be finite."

---

Henry David Thoreau (1817-1862).

**Walden** (1854)

"I had withdrawn so far within the great ocean of solitude, into which the rivers of society empty, that for the most part, so far as my needs were concerned, only the

finest sediment was deposited around me. Beside, there were wafted to me evidences of unexplored and uncultivated continents on the other side." "It is a mistake to suppose that, in a country where the usual evidences of civilization exist, the condition of a very large body of inhabitants may not be as degraded as that of savages."

---

H. G. Wells (1866-1946).  
**The Time Machine.** (1898)  
*Chapter IV.*

"There were no hedges, no signs of proprietary rights, no evidences of agriculture; the whole earth had become a garden." Chapter XII. "SO I came back. For a long time I must have been insensible upon the machine. The blinking succession of the days and nights was resumed, the sun got golden again, the sky blue. I breathed with greater freedom. The fluctuating contours of the land ebbed and flowed. The hands spun backward upon the dials. At last I saw again the dim shadows of houses, the evidences of decadent humanity. These, too, changed and passed, and others came."

**A Short History of the World.** (1922)  
*XV. Sumeria, Early Egypt and Writing.*

"It is in lower Mesopotamia however and in Egypt that there first appear cities, temples, systematic irrigation, and evidences of a social organization rising above the level of a mere barbaric village-town." LXIII. European Aggression in Asia, and the Rise of Japan "The quite temporary advantages that the mechanical revolution in the west had given the Europeans over the rest of the old world were regarded by people, blankly ignorant of such events as the great Mongol conquests, as evidences of a permanent and assured European leadership of mankind."

---

Abraham Lincoln. (1809-1865).  
*Speech of Hon. Abraham Lincoln, debate with Douglas. (At Springfield, June 17, 1858.)*

"Let any one who doubts, carefully contemplate that now almost complete legal combination--piece of machinery, so to speak--compounded of the Nebraska doctrine and the Dred Scott decision. Let him consider, not only what work the machinery is adapted to do, and how well adapted, but also let him study the history of its construction, and trace, if he can, or rather fail, if he can, to trace the evidences of design, and concert of action, among its chief architects, from the beginning."

*Third Joint Debate with Douglas at Jonesboro.*  
*Mr. Lincoln's Reply (September 15, 1858)*

"I remember Judge Douglas once said that he saw the **evidences** on the statute books of Congress, of a policy in the origin of government to divide slavery and freedom by a geographical line."

---

Walt Whitman. (1819-1892).

**I. Specimen Days 225.**

*A Week's Visit to Boston*

"In my trip out West, last year, I thought the wand of future prosperity, future empire, must soon surely be wielded by St. Louis, Chicago, beautiful Denver, perhaps San Francisco; but I see the said wand stretch'd out just as decidedly in Boston, with just as much certainty of staying; **evidences** of copious capital-indeed no centre of the New World ahead of it, (half the big railroads in the West are built with Yankees' money, and they take the dividends.)"

---

Theodore Roosevelt (1858-1919).

**Through the Brazilian Wilderness.** (1914)

*I. The Start*

"One of the most interesting **evidences** of the modern advance in Brazil is the establishment near Sao Paulo of an institution especially for the study of these poisonous snakes, so as to secure antidotes to the poison and to develop enemies to the snakes themselves."

**A Book-Lover's Holidays in the Open.** (1916)

*II ACROSS THE NAVAJO DESERT*

"Although they practise polygamy, and divorce is easy, their women are usually well treated; and we saw **evidences** of courtesy and consideration not too common even among civilized people."

**An Autobiography.** (1913)

*III PRACTICAL POLITICS*

"When I knew him he was already making his way up; one of the proofs and **evidences** of which was that he owned a first-class racing trotter-"Alice Lane"-behind which he gave me more than one spin."

---

Fugitive Slave Act (1850)

"And the said court, commissioner, judge, or other person authorized by this act to grant certificates to claimants or fugitives, shall, upon the production of the record and other **evidences** aforesaid, grant to such claimant a certificate of his right to take any such person identified and proved to be owing service or labor as aforesaid, which certificate shall authorized such claimant to seize or arrest and transport such person to the State or Territory from which he escaped: Provided, That nothing herein contained shall be construed as requiring the production of a transcript of such record as evidence as aforesaid."

---

Charles Dickens. (1812-1870).

**David Copperfield.**

*I. I Am Born*

"These **evidences** of an incompatibility of temper induced Miss Betsey to pay him off, and effect a separation by mutual consent." XXXV. Depression "It was not that he had lost his good looks. or his old bearing of a gentleman-for that he had not-but the thing that struck me most was, that with the **evidences** of his native superiority still upon him, he should submit himself to that crawling impersonation of meanness. Uriah Heep."

*XXVII. Tommy Traddles*

"Various ingenious arrangements he had made, for the disguise of his chest of drawers, and the accommodation of his boots, his shaving-glass, and so forth, particularly impressed themselves upon me, as **evidences** of the same Traddles who used to make models of elephants' dens in writing-paper to put flies in; and to comfort himself, under ill-usage, with the memorable works of art I have so often mentioned."

---

H. L. Mencken (1880-1956).

**The American Language.** (1921)

*Preface to the Revised Edition*

"Since my first edition was published there have been various **evidences** of a renewed interest in the contemporary status and development of the language, both in the United States and in England."

*2. The Academic Attitude*

"But during the war he appears to have succumbed to the Propaganda for British-

American unity launched by the eminent Anglo-Saxon idealist, Adolph S. Ochs, of the New York Times. I quote from one of his articles in the Times: 'We may rest assured that the superficial **evidences** of a tendency toward the differentiation of American-English and British-English are not so significant as they may appear to the unreflecting, and that the tendency itself will be powerless against the cohesive force of our common literature, the precious inheritance of both the English-speaking peoples...'"

---

Franklin Pierce (1804-1869).  
*Inaugural Address Friday, March 4, 1853*

"The energy with which that great conflict was opened and, under the guidance of a manifest and beneficent Providence the uncomplaining endurance with which it was prosecuted to its consummation were only surpassed by the wisdom and patriotic spirit of concession which characterized all the counsels of the early fathers. One of the most impressive **evidences** of that wisdom is to be found in the fact that the actual working of our system has dispelled a degree of solicitude which at the outset disturbed bold hearts and far-reaching intellects."

---

Agatha Christie (1890-1976).  
**The Mysterious Affair at Styles.** (1924)  
*10. The Arrest*

"Oh! What did he mean? In spite of myself, an agreeable warmth spread over me. I am not a vain man where women are concerned, but I remembered certain **evidences**, too lightly thought of at the time, perhaps, but which certainly seemed to indicate--"

*12. The Last Link*

"Throughout the case, there have been **evidences** that the tragedy was intended to take place on Monday evening."

---

Ulysses S. Grant (1822-85).  
**Personal Memoirs.** (1885-86).  
*XXVII*

"In consequence of this law, when Memphis was occupied the provost-marshal had forcibly collected all the **evidences** he could obtain of such debts."



---

Stevenson, Robert Louis (1850-1894).

**The Master of Ballantrae.** (1889)

*VI. Summary of Events During the Master's Second Absence.*

"The same day, which was certainly predicated to joy, we observed the first signal of recovery in Mr. Henry; and about three of the following afternoon he found his mind again, recognising me by name with the strongest **evidences** of affection."

---

Jacob A. Riis (1849-1914).

**How the Other Half Lives.** (1890) *XVI. Waifs of the City's Slums*

"If the structure shows signs of being top-heavy, **evidences** are not wanting—they are multiplying day by day—that patient toilers are at work among the underpinnings."

---

Edmund Burke (1729-1797).

**Reflections on the French Revolution.**

*Paras. 50-74*

"By this means our liberty becomes a noble freedom. It carries an imposing and majestic aspect. It has a pedigree and illustrating ancestors. It has its bearings and its ensigns armorial. It has its gallery of portraits; its monumental inscriptions; its records, **evidences**, and titles. We procure reverence to our civil institutions on the principle upon which nature teaches us to revere individual men; on account of their age, and on account of those from whom they are descended."

---

David Hume (1711-76).

**An Enquiry Concerning Human Understanding.** (1748)

*Of Miracles, Part II*

"In destroying a rival system, it likewise destroys the credit of those miracles, on which that system was established; so that all the prodigies of different religions are to be regarded as contrary facts, and the **evidences** of these prodigies, whether weak or strong, as opposite to each other."

---

Edward Sapir (1884-1939).

**Language: An Introduction to the Study of Speech.** (1921)*IX. How Languages Influence Each Other*

"Such examples as these are hardly true **evidences** of a morphological influence exerted by one language on another."

---

Eugene O'Neill (1888-1953).

**Three Plays.** (1922)*II. Anna Christie Act I*

"She is a tall, blond, fully-developed girl of twenty, handsome after a large, Viking-daughter fashion but now run down in health and plainly showing all the outward **evidences** of belonging to the world's oldest profession."

---

Booker T. Washington (1856-1915).

**Up from Slavery: An Autobiography.** (1901)*XIV. The Atlanta Exposition Address*

"The improvement in the character and life of the Negro ministers is one of the most gratifying **evidences** of the progress of the race."

---

Sir Arthur Quiller-Couch (1863-1944).

**On the Art of Writing.** (1916)*X. English Literature in Our Universities*

"Pythagoras, for example, sacrificed an ox on solving the theorem numbered 47 in the first book of Euclid; and even to-day a Professor in his solitary lodge may be encouraged to believe now and then, from certain **evidences** in the sky, that the spirit of Pythagoras is not dead but translated."

---

Michael Faraday

*The Forces of Matter, Delivered before a Juvenile Auditory at the Royal Institution of Great Britain during the Christmas Holidays of 1859-60**Lecture VI.-The Correlation of the Physical Forces*

"See what power it must have to support not only these nails, but all those lumps of

iron hanging on to the end. What, then, can surpass these **evidences** of the change of chemical force into electricity, and electricity into magnetism? I might show you many other experiments whereby I could obtain electricity and chemical action, heat and light from a magnet, but what more need I show you to prove the universal correlation of the physical forces of matter, and their mutual conversion one into another?"

---

Henry Gray (1821-1865).

**Anatomy of the Human Body.** (1918)

*2i. The Liver*

"In the lower vertebrates, e.g., frog, the cells are arranged in tubes with the bile duct forming the lumen and bloodvessels externally. According to Del'epine, **evidences** of this arrangement can be found in the human liver."

---

Stevenson, Robert Louis (1850-1894).

**The Master of Ballantrae.** (1889)

*V. Account of All That Passed on the Night on February 27th, 1757.*

"We made the more speed, I believe, being surrounded by this bustle; visited the scene of the duel, where my lord looked upon the blood with stoicism; and passing farther on toward the landing-place, came at last upon some **evidences** of the truth. For, first of all, where there was a pool across the path, the ice had been trodden in, plainly by more than one man's weight; next, and but a little farther, a young tree was broken, and down by the landing-place, where the traders' boats were usually beached, another stain of blood marked where the body must have been infallibly set down to rest the bearers."

---

George Washington

*Farewell Address* (1796)

"How far in the discharge of my official duties, I have been guided by the principles which have been delineated, the public Records and other **evidences** of my conduct must witness to You and to the world.-To myself the assurance of my own conscience is, that I have at least believed myself to be guided by them."

---

Willa Cather (1873-1947), U. S. novelist.

**Tom Outland.** (1925)  
*The Professor's House.*  
 book II, ch. II.

"To people off alone, as we were, there is something stirring about finding evidences of human labour and care in the soil of an empty country. It comes to you as a sort of message, makes you feel differently about the ground you walk over every day."

---

Nathaniel Hawthorne (1804-1864).  
**The Scarlet Letter.**  
*The Minister in a Maze.*

"Before Mr. Dimmesdale reached home, his inner man gave him other evidences of a revolution in the sphere of thought and feeling."

[Full references](#)

[Glossary](#)

  
[Contents](#)

Home	Browse	Search	Feedback	Links
The FAQ		Must-Read Files		Index
Evolution		Creationism		Age of the Earth
Flood Geology		Catastrophism		Debates

[Home Page](#) | [Browse](#) | [Search](#) | [Feedback](#) | [Links](#)



[The FAQ](#) | [Must-Read Files](#) | [Index](#) | [Creationism](#) | [Evolution](#) | [Age of the Earth](#) | [Flood Geology](#) | [Catastrophism](#) | [Debates](#)



## Contact the author

---

**T**his page was created primarily as a way to keep internet robots from indexing my email address. I welcome feedback, both positive and negative.

[Douglas L. Theobald, Ph.D.](#)

Department of Chemistry and Biochemistry  
University of Colorado at Boulder

[dtheobald AT hotmail DOT com](mailto:dtheobald AT hotmail DOT com)

Home	Browse	Search	Feedback	Links
The FAQ		Must-Read Files		Index
Evolution		Creationism		Age of the Earth
Flood Geology		Catastrophism		Debates

[Home Page](#) | [Browse](#) | [Search](#) | [Feedback](#) | [Links](#)

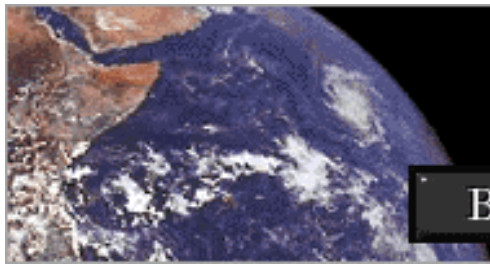

[The FAQ](#) | [Must-Read Files](#) | [Index](#) | [Creationism](#) | [Evolution](#) | [Age of the Earth](#) | [Flood Geology](#) | [Catastrophism](#) | [Debates](#)

[Browse](#)
[Search](#)
[Feedback](#)
[Links](#)

## 29+ Evidences for Macroevolution

### References

Copyright © 1999-2003 by [Douglas L. Theobald, Ph.D.](#)

---



[Contents](#)

- Abel, O. (1908) "Die Morphologie der Huftbeinrudimente der Cetaceen." Denkschr. Math. Naturw. Klasse Kaiserl. Aka. Wiss. Vol. 81.
- Acharya, K. R., D. I. Stuart, et al. (1989) "Refined structure of baboon alpha-lactalbumin at 1.7 Å resolution - comparison with c-type lysozyme." *Journal of Molecular Biology* 208: 99-127.
- Adami, C., C. Ofria, et al. (2000) "Evolution of biological complexity." *PNAS* 97: 4463-4468.
- Albert, J., Wahlberg, J., Leitner, T., Escanilla, D. and Uhlen, M. (1994) "Analysis of a rape case by direct sequencing of the human immunodeficiency virus type 1 pol and gag genes." *J Virol* 68: 5918-24.
- Amasaki, H., Ishikawa, H., and Daigo, M. (1989) "Developmental changes of the fore- and hind-limbs in the fetuses of the southern minke whale, *Balaenoptera acutorostrata*." *Anat Anz* 169: 145-148. [\[PubMed\]](#)
- Andren, C., M. Marden, et al. (1989) "Tolerance to low pH in a population of moor frogs, *Rana arvalis* from an acid and a neutral environment : a possible test case of rapid evolutionary response to acidification." *Oikos* 56: 215-223.
- Andrews, R. C. (1921) "A remarkable case of external hind limbs in a humpback whale." *Amer. Mus. Novitates*. No. 9.
- Aravind, L. and Koonin, E. V. (1999) "DNA polymerase beta-like nucleotidyl transferase superfamily: identification of three new families, classification, and evolutionary history." *Nucleic Acids Research* 27: 1609.

- Archie, J. W. (1989) "A randomization test for phylogenetic information in systematic data." *Systematic Zoology* 38: 219-252.
- Arnold, C., Balfe, P. and Clewley, J. P. (1995) "Sequence distances between env genes of HIV-1 from individuals infected from the same source: implications for the investigation of possible transmission events." *Virology* 211: 198-203.
- Atchely, W. R. and Fitch, W. M. (1991) "Gene trees and the origins of inbred strains of mice." *Science* 254: 554-558.
- Avery, O. T., MacLeod, C. M. and McCarty, M. (1944) "Studies on the chemical nature of the substance inducing transformation of pneumococcal types." *J. Exp. Med.* 79:137-158.
- Avise, J. C. and Wollenberg, K. (1997) "Phylogenetics and the origin of species." *PNAS* 94: 7748D7755.
- Bajpai, S. and Gingerich, P. D. (1998) "A new Eocene archaeocete (Mammalia, Cetacea) from India and the time of origin of whales." *Proc Natl Acad Sci U S A.* 95: 15464-15468. [[PubMed](#)]
- Baldauf, S. L., Roger, A. J., Wenk-Siefert, I., and Doolittle, W. F. (2000) "A kingdom-level phylogeny of eukaryotes based on combined protein data." *Science* 290: 972-7.
- Ban, N., P. Nissen, et al. (1999) "Placement of protien and RNA structures in a 5 Å resolution map of the 50S ribosomal subunit." *Nature* 400: 841-847.
- Bar-Maor, J. A., Kesner, K. M., and Kaftori, J. K. (1980) "Human tails." *J Bone Joint Surg Br.* 62-B: 508-510. [[PubMed](#)]
- Barrell, B. G., et al. (1996) "Life with 6000 genes." *Science* 274: 546-567.
- Barsh, G. S. (1996) "The genetics of pigmentation: from fancy genes to complex traits." *Trends in Genetics* 12: 299-305.
- Barton, N. H. and Gale, R. S. (1993) "Genetic analysis of hybrid zones." **Hybrid Zones and the Evolutionary Process**. New York, Oxford University Press: 12-45.
- Baruchin, A. M., Mahler, D., Hauben, D. J., and Rosenberg, L. (1983) "The human caudal appendage (human tail)." *Br J Plast Surg.* 36: 120-123. [[PubMed](#)]
- Behe, M.J. (1994) "Experimental support for regarding functional classes of proteins to be highly isolated from each other." In **Darwinism, Science or Philisophy?** Eds. Jon Buell and Virginia Hearn, Foundation for Thought and Ethics: Houston, Texas. [[ARNMichael Behe Files](#)]
- Behe, M. (1996) **Darwin's Black Box**. New York, Touchstone.
- Bejder, L. and Hall, B.K. (2002) "Limbs in whales and limblessness in other vertebrates: mechanisms of evolutionary and developmental transformation and loss." *Evol Dev* 4: 445-458. [[PubMed](#)]

- Belzberg, A. J., Myles, S. T., and Trevenen, C. L. (1991) "The human tail and spinal dysraphism." *J Pediatr Surg* 26: 1243-1245.
- Bennett, A. F., R. E. Lenski, et al. (1992) "Evolutionary adaptation to temperature. I. Fitness responses of *Escherichia coli* to changes in its thermal environment." *Evolution* 46: 16-30.
- Benton, M. J. (1998) "Molecular and morphological phylogenies of mammals: Congruence with stratigraphic data." *Molecular Phylogenetics and Evolution* 9: 398-407.
- Benton, M. J. and Hitchin, R. (1996) "Testing the quality of the fossil record by groups and by major habitats." *Historical Biol.* 12: 111-157.
- Benton, M. J. and Hitchin, R. (1997) "Congruence between phylogenetic and stratigraphic data on the history of life." *Proc. R. Soc. Lond. B.* 264: 885-890.
- Benton, M. J., Hitchin, R., and Wills, M. A. (1999) "Assessing congruence between cladistic and stratigraphic data." *Syst. Biol.* 48: 581-596.
- Benton, M. J. and Storrs, G. W. (1994) "Testing the quality of the fossil record: paleontological knowledge is improving." *Geology* 22: 111-114.
- Benton, M. J., Wills, M. A., and Hitchin R. (2000) "Quality of the fossil record through time." *Nature* 403: 534-537.
- Bergman, J. (2000) "Is the inverted human eye a poor design?" *Perspectives on Science and Christian Faith* 52: 18-30.
- Berzin, A. A. (1972) **The Sperm Whale**. Pacific Scientific Research Institute of Fisheries and Oceanography. Israel Program for Scientific Translations, Jerusalem. Available from the U. S. Dept. of Commerce, national Technical Information Service. Springfield, VA.
- Besharse, J. C., and Brandon, R. A. (1976) "Effects of continuous light and darkness on the eyes of the troglobitic salamander *Typhlotriton spelaeus*." *J Morphol* 149: 527-546. [[PubMed](#)]
- Birch, C. J., McCaw, R. F., Bulach, D. M., Revill, P. A., Carter, J. T., Tomnay, J., Hatch, B., Middleton, T. V., Chibo, D., Catton, M. G., Pankhurst, J. L., Breschkin, A. M., Locarnini, S. A. and Bowden, D. S. (2000) "Molecular analysis of human immunodeficiency virus strains associated with a case of criminal transmission of the virus." *J Infect Dis* 182: 941-4.
- Bishop, J. A. (1981) "A neo-Darwinian approach to resistance: Examples from mammals." **Genetic Consequences of Man Made Change**. J. A. Bishop and L. M. Cook. London, Academic Press.
- Blanchard, A., Ferris, S., Chamaret, S., Guetard, D. and Montagnier, L. (1998) "Molecular evidence for nosocomial transmission of human immunodeficiency virus from a surgeon to one of his patients." *J Virol* 72: 4537-40.
- Bohossian, H. B., Skaletsky, H., Page, D. C. (2000) "Unexpectedly similar rates of nucleotide substitution found in male and female hominids." *Nature*. 406: 622-5.



- Bonner, T. I., C. O'Connell, et al. (1982) "Cloned endogenous retroviral sequences from human DNA." PNAS 79: 4709.
- Box, G. E. P. (1978) **Statistics for experimenters : an introduction to design, data analysis, and model building**. New York: John Wiley and Sons.
- Brand, L. (1997) **Faith, Reason, and Earth History: A Paradigm of Earth and Biological Origins by Intelligent Design** Berrien Springs, MI: Andrews University Press.
- Branden, C. and Tooze, J. (1999) **Introduction to Protein Structure**. Second Ed., New York, Garland Publishing. [\[Publisher's Site\]](#)
- Brenner, S. (1957) "On the impossibility of all overlapping triplet codes in information transfer from nucleic acid to proteins." PNAS 43:687-694.
- Britton-Davidian, J., J. Catalan, et al. (2000) "Rapid chromosomal evolution in island mice." Nature 403: 158.
- Brooks, D. R. and McLennon, D. A. (1991) **Phylogeny, ecology, and behavior**. Chicago, University of Chicago Press.
- Brown, J. H. and Lomolino, M. V. (1998) **Biogeography**. Second edition. Boston, MA: Sunderland.
- Brown, J. R., Douady, C. J., Italia, M. J., Marshall, W. E., and Stanhope, M. J. (2001) "Universal trees based on large combined protein sequence data sets." Nature Genetics 28: 281-285.
- Buell, J. and Ahearn, Eds., V. (1994) **Darwinism, Science or Philosophy?**
- Bunn, H. F. and Forget, E. G. (1986) **Hemoglobin: Molecular, Genetic, and Clinical Aspects**, Saunders.
- Bush, R. M., C. A. Bender, et al. (1999) "Predicting the evolution of human influenza A." Science 286: 1921-1925.
- Carpenter, M. A. and O'Brien, S. J. (1995) "Coadaptation and immunodeficiency virus: lessons from the Felidae." Current Opinion in Genetics and Development 5: 739-745.
- Carroll, R. L. (1988) **Vertebrate Paleontology and Evolution**. New York, W. H. Freeman and Co.
- Carroll, R. L. (1997) Patterns and Processes of Vertebrate Evolution. Cambridge, Cambridge University Press.
- Carter, G. S. (1954) **Animal Evolution**. London, Sidgwick and Jackson.
- Cech, T. R., A. J. Zaugg, et al. (1981) "In vitro splicing of the ribosomal RNA precursor of Tetrahymena: involvement of a guanosine nucleotide in the excision of the intervening sequence." Cell 27: 487- 496.

Chalmers, A. F. (1982) **What is this thing called Science?** Queensland, Australia, University of Queensland Press.

Chan, B. W., Chan, K. S., Koide, T., Yeung, S. M., Leung, M. B., Copp, A. J., Loeken, M. R., Shiroishi, T., and Shum, A. S. (1994) "Maternal diabetes increases the risk of caudal regression caused by retinoic acid." *Diabetes* 51: 2811-2816. [\[PubMed\]](#)

Chatterjee, S. (1997) **The Rise of Birds: 225 million years of evolution.** Baltimore, MD, Johns Hopkins University Press.

Chen, P.-j., Z.-m. Dong, et al. (1998) "An exceptionally well- preserved theropod dinosaur from the Yixian formation of China." *Nature* 391: 147-152.

Chervitz, S. A., et al. (1998) "Comparison of the complete protein sets of worm and yeast: Orthology and divergence." *Science* 282: 2022- 2028.

Clements, J. M., O'Connell, L. I., Tsunasawa, S., and Sherman, F. (1989) "Expression and activity of a gene encoding rat cytochrome *c* in the yeast *Saccharomyces cerevisiae*." *Gene* 83: 1-14.

Clemons, W. M., J. L. C. May, et al. (1999) "Structure of a bacterial 30S ribosomal subunit at 5.5. Å resolution." *Nature* 400: 833-840.

Clyde, W. C. and Fisher, D. C. (1997) "Comparing the fit of stratigraphic and morphologic data in phylogenetic analysis." *Paleobiology* 23: 1-19.

Cohn, M. J. (2001) "Developmental mechanisms of vertebrate limb evolution." *Novartis Found Symp.* 232: 47-57. [\[PubMed\]](#)

Cohn, M. J., and Tickle, C. (1999) "Developmental basis of limblessness and axial patterning in snakes." *Nature* 399: 474-479. [\[PubMed\]](#)

Consortium, C. e. S. (1998) "Genome sequence of the nematode *C. elegans*: A platform for investigating biology." *Science* 282: 2012-2018.

Copley, S. C. (2000) "Evolution of a metabolic pathway for degradation of a toxic xenobiotic: the patchwork approach." *TIBS* 25: 261-265.

Crapo, R. (1985) "Are the vanishing teeth of fetal baleen whales useless?" *Origins Research* 7: 1.

Crick, F. H. C. (1968) "The origin of the genetic code." *Journal of Molecular Biology* 38: 367-379.

Crick, F. H.C., Barnett, L., Brenner, S., and Watts-Tobin., R. J. (1961) "General nature of the genetic code for proteins." *Nature* 192:1227-1232.

Crowe, J. F. (1993) "Mutation, fitness, and genetic load." *Oxford Survey of Evolutionary Biology* 9: 3-42.

- Culver, D.C., Fong, D.W., and Kane T.C. (1995) "Vestigialization and Loss of Nonfunctional Characters." *Annual Review of Ecology and Systematics* 26: 249-268.
- Cummins, R. (1975) "Functional Analysis." *Journal of Philosophy* 72: 741-765.
- Cunningham, C. W., Omland, K. E., and Oakley, T. H. (1998) "Reconstructing ancestral character states: a critical reappraisal." *Trends in Ecology and Evolution* 13: 361-366.
- Dao, A. H. and Netsky, M. G. (1984) "Human tails and pseudotails." *Human Pathology* 15: 449-453.
- Dangel, A. W., B. J. Baker, et al. (1995) "Complement component C4 gene intron 9 as a phylogenetic marker for primates: long terminal repeats of the endogenous retrovirus ERV-K(C4) are a molecular clock of evolution." *Immunogenetics* 42: 41-52.
- Darwin, C. (1871) **The Descent of Man**. Amherst, New York, Prometheus Books.
- Darwin, C. (1872) **On the Origin of Species**. New York, Random House.
- Davies, J. C. I., R. J. Almassey, et al. (1994) "2.3 Å crystal structure of the catalytic domain of DNA polymerase beta." *Cell* 76: 1123-1133.
- Dawkins, R. (1996) **The Blind Watchmaker**. New York, Norton.
- Dawkins, R. (1999) **The Extended Phenotype**. Oxford, Oxford University Press.
- Deininger, P. L., and Batzer, M. A. (1999) "Alu repeats and human disease." *Mol Genet Metab.* 67: 183-193.
- Diamond, J. M. (1984a) "Historic extinctions: A Rosetta Stone for understanding pre-historic extinctions." **Quaternary Extinctions: A Prehistoric Revolution**. P. S. Martin and R. G. Klein. Tucson, University of Arizona Press: 824-862.
- Diamond, J. M. (1984b) "Normal" extinctions of isolated populations. *Extinctions*. M. Nitecki. Chicago, University of Chicago Press: 191-246.
- Dickerson, R. E. (1972) *Scientific American*. 226: 58-72.
- Dickerson, R. E. and Timkovich, R. (1975) **cytochrome c. The Enzymes**. P. D. Boyer. New York, Academic Press. 11: 397-547.
- Dickinson, W. J. (1995) "Molecules and morphology: where's the homology?" *Trends Genet.* 11: 119-121. [\[PubMed\]](#)
- Dodson, E. O. (1960) **Evolution: Process and Product**. New York: Reinhold Publishers.
- Domning, D. P. (2001) "The earliest known fully quadrupedal sirenian." *Nature*. 413: 625-627. [\[PubMed\]](#)

- Doolittle, W. F. (1999) "Phylogenetic Classification and the Universal Tree." *Science* 284: 2124.
- Doolittle, W. F. (2000) "The nature of the universal ancestor and the evolution of the proteome." *Current Opinion in Structural Biology* 10: 355-358.
- Dowson, C. G., Coffey, T. J., Spratt, B. G. (1994) "Origin and molecular epidemiology of penicillin-binding-protein-mediated resistance to beta-lactam antibiotics." *Trends Microbiol* 2: 361-66.
- Dubrow, T. J., Wackym, P. A., and m. A. Lesavoy. (1988) "Detailing the human tail." *Annals of Plastic Surgery* 20:340-344.
- Durand, J., Keller, N., Renard, G., Thorn, R., and Pouliquen, Y. (1993) "Residual cornea and the degenerate eye of the cryptophthalmic *Typhlotriton spelaeus*." *Cornea* 12: 437-447. [[PubMed](#)]
- Eldredge, N. and Gould, S. J. (1972) "Punctuated equilibrium: An alternative to phyletic gradualism." In **Models in Paleobiology**. Ed. T. J. M. Schopf. San Francisco, CA, Freeman, Cooper, and Company: 82-115.
- Endler, J. A. (1986) **Natural Selection in the Wild**. Princeton, NJ, Princeton University Press.
- Faith, D. P. and Cranston, P. S. (1991) "Could a cladogram this short have arisen by chance alone?: on permutation tests for cladistic structure." *Cladistics* 7: 1-28.
- Fallon, J. F., and Simandl, B. K. (1978) "Evidence of a role for cell death in the disappearance of the embryonic human tail." *Am J Anat* 152: 111-129. [[PubMed](#)]
- Fara, M. (1977) "Coccygeal ('tail') projection with cartilage content." *Acta Chir. Plast.* 19: 50-55.
- Farris, J. S. (1989) "The retention index and the rescaled consistency index." *Cladistics* 5:417-419.
- Felsenstein, J. (1982) "Numerical methods for inferring evolutionary trees." *Quart. Rev. Biol.* 57: 379-404.
- Felsenstein, J. (1985) "Confidence limits on phylogenies: an approach using the bootstrap." *Evolution* 39: 783-791.
- Fisher, R. A. (1990) **Statistical methods, experimental design, and scientific inference**. Bennet, J. H. ed., Oxford: Oxford University Press.
- Ffrench-Constant, R. H., N. Anthony, et al. (2000) "Cyclodiene insecticide resistance: from molecular to population genetics." *Annual Review of Entymology* 45: 449-466.
- Fisher, R. A. (1942) **The Design of Experiments**. Edinburgh, Oliver and Boyd.
- Fitch, W. M. (1970) "Distinguishing homologous from analogous proteins." *Syst. Zool.* 28: 132-163.
- Freeman, S. and Herron, J. C. (2004) **Evolutionary analysis** Third edition. Upper Saddle River, NJ: Pearson/Prentice Hall.

- Freitag, J., G. Ludwig, et al. (1998) "Olfactory receptors in aquatic and terrestrial vertebrates." *Journal of Comparative Physiology* 183: 635-650.
- Futuyma, D. (1998) **Evolutionary Biology**. Third edition. Sunderland, Mass., Sinauer Associates.
- Galili, U. and Swanson, K. (1991) "Gene sequences suggest inactivation of alpha-1,3-galactosyltransferase in catarrhines after the divergence of apes from monkeys." *PNAS* 88: 7401-7404.
- Galton, F. and Watson, H.W. (1874) "On the probability of the extinction of families." *Journal of the Royal Anthropological Institute* 4: 138-144.
- Garavelli, J. S., Hou, Z., et al. (2001) "The RESID Database of protein structure modifications and the NRL-3D Sequence-Structure Database." *Nucleic Acids Research* 29: 199-201. <http://www.ncifcrf.gov/RESID/>
- Garstang, W. (1922) "The theory of recapitulation: a critical restatement of the biogenetic law." *The Journal of the Linnean Society of London. Zoology* 35: 81-101.
- Geoffroy St. Hilaire (1798) "Observations sur l'aile de l'Autruche, par le citoyen Geoffroy." in **La Decade Egyptienne, Journal Litteraire et D'Economie Politique**. Premier Volume. Au Kaire, de L'Imprimerie Nationale. pp. 46-51
- Giannelli, F., Anagnostopoulos, T., and Green, P. M. (1999) "Mutation rates in humans. II. Sporadic mutation-specific rates and rate of detrimental human mutations inferred from hemophilia B." *Am J Hum Genet* 65: 1580-1587.
- Gilbert, S. F., Opitz, J. M. and Raff, R. A. (1996) "Resynthesizing evolutionary and developmental biology." *Developmental Biology* 173: 357-372.
- Gilbert, S. F. (1997) **Developmental Biology**. Fifth edition. Sinauer Associates.
- Gilbert, W. (1986) "The RNA World." *Nature* 319: 618.
- Gingerich, P. D. (1983) "Rates of evolution: Effects of time and temporal scaling." *Science* 222: 159-161.
- Gingerich, P., Wells, N. A., Russell, D. E., and Shah, S. M. I. (1983) "Origin of whales in epicontinental remnant seas: new evidence from the early Eocene of Pakistan." *Science* 220: 403-406.
- Gingerich, P., Smith, B. H., and Simons, E. L. (1990) "Hind limbs of Eocene *Basilosaurus*: evidence of feet in whales." *Science* 249: 154-157.
- Gingerich, P., Raza, S. M., Arif, M., Anwar, M., and Zhou, X. (1994) "New whale from the Eocene of Pakistan and the origin of cetacean swimming." *Nature* 368: 844-847.
- Gingerich, P. D., Haq Mu, Zalmout, I. S., Khan, I. H., and Malkani, M. S. (2001). "Origin of whales from early artiodactyls: hands and feet of Eocene Protocetidae from Pakistan." *Science*. 293: 2239-2242. [\[PubMed\]](#)

Gish, D. T. (1978) **Evolution? The Fossils Say No!** Public School Edition, San Diego: Creation-Life Publishers.

Gish, D. T. (1983) "Evolution and the human tail." ICR Impact No. 117.

Givnish, T.J., and Sytsma, K.J. (1997) "Consistency, characters, and the likelihood of correct phylogenetic inference." *Mol Phylogenet Evol.* 7: 320-330. [[PubMed](#)]

Goldsmith, T. H. (1990) "Optimization, constraint, and history in the evolution of eyes." *Quarterly Review of Biology* 65: 281-322.

Goodman, M., B. F. Koop, et al. (1989) "Molecular phylogeny of the family of apes and humans." *Genome* 31: 316-335.

Goujon, C. P., Schneider, V. M., Grofti, J., Montigny, J., Jeantils, V., Astagneau, P., Rozenbaum, W., Lot, F., Frocrain-Herchkovitch, C., Delphin, N., Le Gal, F., Nicolas, J. C., Milinkovitch, M. C. and Deny, P. (2000) "Phylogenetic analyses indicate an atypical nurse-to-patient transmission of human immunodeficiency virus type 1." *J Virol* 74: 2525-32.

Gould, S. J. (1990) "An earful of jaw." *Natural History* 3: 12-23.

Gould, S. J. (2002) **The Structure of Evolutionary Theory.** Cambridge, MA: Belknap Press of Harvard University Press.

Gould, S. J. and Eldredge, N. (1977) "Punctuated equilibria: The tempo and mode of evolution reconsidered." *Paleobiology* 3: 115-151.

Grange, G., Tantau, J., Pannier, E., Aubry, M. C., Viot, G., Fallet-Bianco, C., Terrasse, G., and Cabrol, D. (2001) "Prenatal diagnosis of fetal tail and postabortum anatomical description." *Ultrasound Obstet Gynecol* 18: 531-533. [[PubMed](#)]

Greco, T. L., Takada, S., Newhouse, M. M., McMahon, J. A., McMahon, A. P., Camper, S. A. (1996) "Analysis of the vestigial tail mutation demonstrates that Wnt-3a gene dosage regulates mouse axial development." *Genes Dev* 10: 313-324. [[PubMed](#)]

Gregory, W. K. (1951) **Evolution Emerging: A survey of changing patterns from primeval life to man. Volume I.** The Macmillan Co., New York.

Griffiths, P. (1992) "Adaptive explanation and the concept of a vestige." in **Trees of Life: essays in philosophy of biology.** Edited by Paul Griffiths. Dordrecht, Boston: Kluwer Academic Publishers.

Groves, C. P. (2000) "The genus *Cheirogaleus*: Unrecognized biodiversity in dwarf lemurs." *International Journal of Primatology*. 21(6): 943-962.

Gruneberg, H. and Wickramaratne, G. A. (1974) "A re-examination of two skeletal mutants of the mouse, vestigial-tail (vt) and congenital hydrocephalus (ch)." *J Embryol Exp Morphol.* 31: 207-22. [[PubMed](#)]

Gura, T. (2000) "Bones, molecules ... or both?" *Nature* 406: 230-233.

Haag, F., F. Koch-Nolte, et al. (1994) "Premature stop codons inactivate the RT6 genes of the human and chimpanzee species." *Journal of Molecular Biology* 243: 537-546.

Haeckel, E. (1898) **The Last Link**. Adam and Charles Black, London.

Hairston, N. G., Jr. (1990) "Fluctuating selection and response in a population of freshwater copepods." *Evolution* 44: 1796-1805.

Hall, B. G. (1982) "Evolution on a petri dish: The evolved b- galactosidase system as a model for studying acquisitive evolution in the laboratory." *Evolutionary Biology* 15: 85-150.

Hall, B. K. (1984) "Developmental mechanisms underlying the formation of atavisms." *Biol. Rev.* 59: 89-124.

Hall, B. K. (1995) "Atavisms and atavistic mutations." *Nature Genetics* 10: 126-127.

Ham, K., Sarfati, J. and Wieland, C. (1990) **The Answers Book - Revised & Expanded**, Batten, D. ed., Master Books. <http://www.answersingenesis.org/docs/446.asp>

Ham, K., and Wieland, C. (1997) "Your appendix: It's there for a reason." *Creation Ex Nihilo* 20: 41-43. <http://www.answersingenesis.org/docs/357.asp>

Hampsey, D. M., Das, G., and Sherman F. (1986) "Amino acid replacements in yeast iso-1-cytochrome c." *Journal of Biological Chemistry* 261: 3259-71.

Hampsey, D. M., Das, G., and Sherman F. (1988) "Yeast iso-1- cytochrome c: genetic analysis of structural requirements." *FEBS Letters* 231: 275-83.

Harris, J. I., F. Sanger, et al. (1956) "Species differences in insulin." *Archives of Biochemistry and Biophysics* 65: 427-438.

Harris, T. E. (1989) **The Theory of Branching Processes**. New York, Dover.

Harrison, R. G. (1901) "Occurrence of tails in man, with a description of a case reported by Dr. Watson." *Johns Hopkins Hosp. Bull.* 12:96-101.

Hastings, M. L. and Krainer, A. R. (2001) "Pre-mRNA splicing in the new millennium." *Curr Opin Cell Biol* 13: 302-309.

Hattab, F. N., Rawashdeh, M. A., and Fahmy, M. S. (1995) "Impaction status of third molars in Jordanian students." *Oral Surg Oral Med Oral Pathol Oral Radiol Endod.* 79: 24-29. [\[PubMed\]](#)

Hedges, S. B. (1994) "Molecular evidence for the origin of birds." *PNAS* 91: 2621-2624.

Hedges, S. B. and Poling, L. L. (1999) "A molecular phylogeny of reptiles." *Science* 283: 998-1001.

Hendy, M. D., Little, C. H. C., and Penny, D. (1984) "Comparing trees with pendant vertices labelled." SIAM J. Appl. Math. 44: 1054-1065.

Hennig, W. (1966) **Phylogenetic Systematics**. Urbana, University of Illinois Press.

Heston, W. E. (1951) "the 'vestigial tail' mouse. A new recessive mutation." J Hered. 42: 71-74.

Hickey, D. R., Jayaraman, K., Goodhue, C. T., Shah, J., Fingar, S. A., Clements, J. M., Hosokawa, Y., Tsunasawa, S., and Sherman, F. (1991) "Synthesis and expression of genes encoding tuna, pigeon, and horse cytochromes *c* in the yeast *Saccharomyces cerevisiae*." Gene 105: 73-81.

Hill, W. C.O. (1974) **Primates: Comparative Anatomy and Taxonomy. VII. Cyropithecinae: Cercocebus, Maccaca, Cynopithecus**. New York, Halstead Press, John Wiley and Sons.

Hillis, D. M. (1991) "Discriminating between phylogenetic signal and random noise in DNA sequences." In Phylogenetic analysis of DNA sequences. pp. 278-294 M. M. Miyamoto and J. Cracraft, eds. New York: Oxford University Press.

Hillis, D. M., and Bull, J. J. (1993) "An empirical test of bootstrapping as a method for assessing confidence on phylogenetic analysis." Syst. Biol. 42: 182-192.

Hillis, D. M., J. J. Bull, et al. (1992) "Experimental phylogenetics: Generation of a known phylogeny." Science 255: 589-592. [\[PubMed\]](#)

Hillis, D. M., and Huelsenbeck, J. P. (1992) "Signal, noise, and reliability in molecular phylogenetic analyses." Journal of Heredity 83: 189-195. [\[PubMed\]](#)

Hillis, D. M., J. P. Huelsenbeck, et al. (1994) "Application and accuracy of molecular phylogenies." Science 264: 671-677.

Hillis, D. M., Moritz, C. and Mable, B. K. Eds. (1996) **Molecular systematics**. Sunderland, MA: Sinauer Associates.

Hindmarsh, P. and Leis., J. (1999) "Retroviral DNA Integration." Microbiology and Molecular Biology Reviews 63: 836-843.

Hinegardner, T. T. and Engelberg., J. (1963) "Rationale for a Universal Genetic Code." Science 142: 1083-1085.

Hitchin, R. and Benton, M. J. (1997) "Congruence between parsimony and stratigraphy: comparisons of three indices." Paleobiology 23: 20-32.

Hofreiter, M., Serre, D., Poinar, H. N., Kuch, M., and Paabo, S. (2001) "Ancient DNA." Nat Rev Genet 2: 353-359.

Holmes, E. C., Zhang, L. Q., Simmonds, P., Rogers, A. S. and Brown, A. J. (1993) "Molecular investigation of human immunodeficiency virus (HIV) infection in a patient of an HIV-infected surgeon." J Infect Dis 167:



1411-4.

Hooten, E. A. (1947) **Up From the Ape**. Second edition. New York: Macmillan.

Houde, A. E. (1988) "Genetic differences in female choice between two guppy populations." *Animal Behavior* 36: 510-516.

Hudson, R. R. (1992) "Gene trees, species trees and the segregation of ancestral alleles." *Genetics* 131: 509-513. [\[PubMed\]](#)

Huelsenbeck, J. P. (1994) "Comparing the stratigraphic record to estimates of phylogeny." *Palaeobiology* 20: 470-483.

Huelsenbeck, J. P., Ronquist, F., Nielsen, R., and Bollback, J. P. (2001) "Bayesian inference of phylogeny and its impact on evolutionary biology." *Science* 294: 2310-2314. [\[PubMed\]](#)

Hutter, H. e. a. (2000) "Conservation and novelty in the evolution of cell adhesion and extracellular matrix genes." *Science* 287: 989-994.

Huttley, G. A., Jakobsen, I. B., Wilson, S. R., Eastal, S. (2000) "How important is DNA replication for mutagenesis?" *Mol Biol Evol.* 17: 929-37.

Huxley, T. H. (1900) **Life and letters of Thomas Henry Huxley**. London, MacMillan.

Ikpeze, O. C., and Onuigbo, W. I. (1999) "A bisegmented human tail in an African baby." *Br J Plast Surg.* 52: 329-330. [\[PubMed\]](#)

International Human Genome Sequencing Consortium (2001) "Initial sequencing and analysis of the human genome." *Nature* 409: 860-921.

Irwin, D.E., Irwin, J.H., and Price, T.D. (2001) "Ring species as bridges between microevolution and speciation." *Genetica.* 112-113: 223-243. [\[PubMed\]](#)

Jeffery, W. R. (2001) "Cavefish as a model system in evolutionary developmental biology." *Dev Biol.* 231: 1-12. [\[PubMed\]](#)

Ji, Q., Norell, M. A., Gao, K-Q., Ji, S-A., and Ren, D. (2001) "The distribution of integumentary structures in a feathered dinosaur." *Nature* 410: 1084-1088.

Johnston, R. F. and Selander, R. K. (1973) "Evolution in the house sparrow. III. Variation in size and sexual dimorphism in Europe and North and South America." *American Naturalist* 107: 373-390.

Joyce, G. F. (1999) "Appendix 3: Reactions catalyzed by RNA and DNA enzymes." In **The RNA World**. R. F. Gesteland, T. R. Cech and J. F. Atkins. Cold Spring Harbor, New York, Cold Spring Harbor Lab Press: 687-690.

Joyce, G. F. and Orgel, L. (1999) "Prospects for Understanding the Origin of the RNA World." In **The RNA**

**World.** R. F. Gesteland, T. R. Cech and J. F. Atkins. Cold Spring Harbor, New York, Cold Spring Harbor Lab Press: 49-77.

Judson, H. F. (1996) **The Eighth Day of Creation: Makers of the Revolution in Biology.** Expanded edition. Cold Spring Harbor Press.

Kardong, K. V. (2002) **Vertebrates: Comparative Anatomy, Function, Evolution.** Third ed. New York: McGraw Hill.

Katoh, M. (2002) "Molecular cloning and expression of mouse Wnt14, and structural comparison between mouse Wnt14-Wnt3a gene cluster and human WNT14-WNT3A gene cluster." *Int J Mol Med* 9 :221-227. [\[PubMed\]](#)

Kawaguchi, H., C. O'hUigin, et al. (1992) "Evolutionary origin of mutations in the primate cytochrome P450c21 gene." *American Journal of Human Genetics* 50: 766-780.

Kazazian, H. H., C. Wong, et al. (1988) "Haemophilia A resulting from de novo insertion of L1 sequences represents a novel mechanism for mutation in man." *Nature* 332: 164.

Kemp, J. S. (1982) **Mammal-like reptiles and the origin of mammals.**

Kestenbaum, D. (1998) "Gravity Measurements Close in on Big G." *Science* 282: 2180-2181.

King, M. C. and Wilson, A. C. (1975) "Evolution at two levels in humans and chimpanzees." *Science* 188: 107-116.

Kjellman, C., H. O. Sjogren, et al. (1999) "HERV-F, a new group of human endogenous retrovirus sequences." *Journal of General Virology* 80: 2383.

Klassen, G. J., Mooi, R. D., and Locke., A. (1991) "Consistency indices and random data." *Syst. Zool.* 40:446-457.

Kos, M., Bulog, B., Szel, A., and Rohlich, P. (2001) "Immunocytochemical demonstration of visual pigments in the degenerate retinal and pineal photoreceptors of the blind cave salamander (*Proteus anguinus*)." *Cell Tissue Res* 303: 15-25.

Koshy, T. I., Luntz, T. L., Garber, E. A., and Margoliash, E. (1992) "Expression of recombinant cytochromes c from various species in *Saccharomyces cerevisiae*: post-translational modifications." *Protein Expr. Purif.* 3: 441-52.

Krings, M., Capelli, C., Tschentscher, F., Geisert, H., Meyer, S., von Haeseler, A., Grossschmidt, K., Possnert, G., Paunovic, M., and Paabo, S. (2000) "A view of Neandertal genetic diversity." *Nat Genet* 26: 144-146.

Kuhn, T. (1970) **The Structure of Scientific Revolutions.**

Kumar, S. and Subramanian, S. (2002) "Mutation rates in mammalian genomes." *Proc Natl Acad Sci* 99: 803-808.

- Lakatos, I. (1974) *Falsification and the Methodology of Scientific Research Programmes*. Criticism and the Growth of Knowledge. I. Lakatos and A. Musgrave. Cambridge, Cambridge University Press: 91-196.
- Lamarck, J. B. (1809) **Zoological Philosophy: An Exposition with Regard to the Natural History of Animals** Translated by Hugh Elliot. Chicago and London: University of Chicago Press. 1984.
- Lebedev, Y. B., Belonovitch, O. S., Zybrowa, N. V, Khil, P. P., Kurdyukov, S. G., Vinogradova, T. V., Hunsmann, G., and Sverdlov, E. D. (2000) "Differences in HERV-K LTR insertions in orthologous loci of humans and great apes." *Gene* 247: 265-277.
- Lederberg, J. and Lederberg, E. M. (1952) "Replica plating and indirect selection of bacterial mutants." *Journal of Bacteriology* 63: 399-406.
- Ledley, F. D. (1982) "Evolution and the human tail." *New Eng. J. Med.* 306: 1212-1215.
- Lee, S. G., B. D. Yoon, et al. (1998) "Isolation of a novel pentachlorophenol-degrading bacterium, *Pseudomonas* sp. Bu34." *Journal of Applied Microbiology* 85: 1-8.
- Lehman, N. (2001) "Please release me, genetic code." *Current Biology* 11: R63-R66.
- Lesk, Arthur M. (2001) **Introduction to Protein Architecture**. Oxford, Oxford University Press. [\[Publisher's Site\]](#)
- Lewin, B. (1999) **Genes VII**. New York, Oxford University Press.
- Li, W.-H. (1997) **Molecular Evolution**. Sunderland, MA, Sinauer Associates.
- Litonjua, L. S. (1996) "Pericoronitis, deep fascial space infections, and the impacted third molar." *J Philipp Dent Assoc.* 47: 43-47. [\[PubMed\]](#)
- Lundberg, G. D. and Parsons, R. W. (1962) "A case of human tail." *Am. J. Dis. Child* 104: 72.
- Luo, Z-X., Crompton, A. W. and A-L Sun. (2001) "A new mammaliaform from the early Jurassic and evolution of mammalian characteristics." *Science* 292: 1535-1539.
- Luria, S. and Delbruck, M. (1943) "Mutations of bacteria from virus sensitivity to virus resistance." *Genetics* 28: 491-511.
- Lyons-Weiler, J., Hoeker, G. A., and Tausch, R. J. (1996) "Relative Apparent Synapomorphy Analysis (RASA) I: The Statistical Measurement of Phylogenetic Signal." *Mol. Biol. Evol.* 13: 749-757.
- MacFadden, B. J. (1992) **Fossil Horses: Systematics, Paleobiology, and Evolution of the Family Equidae**. New York, Cambridge University Press.
- Machuca, R., Jorgensen, L. B., Theilade, P. and Nielsen, C. (2001) "Molecular investigation of transmission of human immunodeficiency virus type 1 in a criminal case." *Clin Diagn Lab Immunol* 8: 884-90.

Maddison, W. P. and Maddison, D. R. (1992) **MacClade: Analysis of Phylogeny and Character Evolution**. Sunderland, Massachusetts, Sinauer.

Maizels, N. and Weiner, A. M. (1999) "The Genomic Tag Hypothesis: What Molecular Fossils Tell Us about the Evolution of tRNA." In **The RNA World**. R. F. Gesteland, T. R. Cech and J. F. Atkins. Cold Spring Harbor, New York, Cold Spring Harbor Lab Press: 79-111.

Maley, L. E. and Marshall, C. R. (1998) "The coming age of molecular systematics." *Science* 279: 505-506.

Matsuo, T., Koga, H., Moriyama, T., Yamashita, H., Imazato, K., and Kondo, M. (1993) "[A case of true human tail accompanied with spinal lipoma.]" *No Shinkei Geka* 21: 925-929.

Matthews, B. W. (1996) "Structural and genetic analysis of the folding and function of T4 lysozyme." *FASEB J.* 10: 35-41.

Mayo, D. (1996) **Error and the Growth of Experimental Knowledge**. Chicago, University of Chicago Press.

Mayr, E. (1942) **Systematics and the Origin of Species**. New York, Columbia University Press.

Mayr, E. (1991) **One Long Argument**. Cambridge, Harvard University Press.

Mayr, E. a. P. D. A. (1990) **Principles of Systematic Zoology**.

McCabe, J. (1912) **The Story of Evolution**. Boston: Small, Maynard, and Co.

McLaughlin, P. J. and Dayhoff, M. O. (1973) "Eukaryote evolution: a view based on cytochrome *c* sequence data." *Journal of Molecular Evolution* 2(99-116)

Merrell, D. J. (1962) **Evolution and Genetics: The Modern Theory of Evolution**. New York: Holt, Rinehart and Winston.

Mes, T. H., Kuperus, P., Kirschner, J., Stepanek, J., Storchova, H., Oosterveld, P., and den Nijs, J. C. (2002) "Detection of genetically divergent clone mates in apomictic dandelions." *Mol Ecol.* 2002 11: 253-265.

[\[PubMed\]](#)

Mighell, A. J., Smith N. R., Robinson P. A., and Markham, A. F. (2000) "Vertebrate pseudogenes." *FEBS Lett.* 468: 109-114.

Millikan, R. (1989) "In defence of proper functions." *Philosophy of Science* 56: 288-302.

Mohrenweiser, H. (1994) "Impact of the molecular spectrum of mutational lesions on estimates of germinal gene-mutation rates." *Mutation Research* 304: 119-137.

Moody, P. A. (1953) **Introduction to Evolution**. First edition. New York: Harper and Row.

- Moody, P. A. (1962) **Introduction to Evolution**. Second edition. New York: Harper and Row.
- Moore, G. R. and Pettigrew, G. W. (1990) **Cytochromes c: Evolutionary, Structural and Physicochemical Aspects**. Berlin, Springer-Verlag.
- Moore, K. L. and Persaud, T. V. N. (1998) **The developing human: clinically oriented embryology**. 6th ed., editor Schmitt, W., Saunders, Philadelphia.
- Moritz, C., C. J. Schneider, et al. (1982) "Evolutionary relationships within the *Ensatina eschscholtzii* complex confirm the ring species interpretation." *Systematic Biology* 41: 273-291.
- Morris, H. (1986) The Vanishing Case for Evolution - [IMPACT No. 156 June 1986](#).
- Morton, E. S. (1990) "Habitat segregation by sex in the hooded warbler: Experiments on proximate causation and discussion of its evolution." *American Naturalist* 135: 319-333.
- Muller, G. B. (2002) "Vestigial Organs and Structures." in **Encyclopedia of evolution** . Mark Pagel, editor in chief, New York: Oxford University Press.
- Negoro, S., Kato, K., Fujiyama, K., Okada, H. (1994) "The nylon oligomer biodegradation system of *Flavobacterium* and *Pseudomonas*." *Biodegradation*. 5: 185-194.
- Nievelstein, R. A., Hartwig, N. G., Vermeij-Keers, C., and Valk, J. (1993) "Embryonic development of the mammalian caudal neural tube." *Teratology* 48: 21-31. [\[PubMed\]](#)
- Nemoto, T. (1963) "New records of sperm whales with protruded rudimentary hind limbs." *Sci. Rep. Whales Res. Inst.* No. 17.
- Nichols, R. (2001) "Gene trees and species trees are not the same." *Trends Ecol Evol*. 16: 358-364. [\[PubMed\]](#)
- Nishikimi, M., R. Fukuyama, et al. (1994) "Cloning and chromosomal mapping of the human nonfunctional gene for L-gulono-gamma-lactone oxidase, the enzyme for L-ascorbic acid biosynthesis missing in man." *Journal of Biological Chemistry* 269: 13685-13688.
- Nishikimi, M., T. Kawai, et al. (1992) "Guinea pigs possess a highly mutated gene for L-gulono-gamma-lactone oxidase, the key enzyme for L-ascorbic acid biosynthesis missing in this species." *Journal of Biological Chemistry* 267: 21967-21972.
- Noller, H. F. (1999) "On the Origin of the Ribosome: Coevolution of Subdomains of tRNA and rRNA." In **The RNA World**. R. F. Gesteland, T. R. Cech and J. F. Atkins. Cold Spring Harbor, New York, Cold Spring Harbor Lab Press: 197-219.
- Noller, H. F., B. Hoffarth, et al. (1992) "Unusual resistance of peptidyl transferase activity to protein extraction methods." *Science* 256: 1416-1419.
- Norell, M. A. and Clarke, J. A. (2001) "Fossil that fills a critical gap in avian evolution." *Nature* 409: 181-184.

- Norell, M. A., Ji, Q., Gao, K., Yuan, C., Zhao, Y., and Wang, L. (2002) "'Modern' feathers on a non-avian dinosaur." *Nature* 416: 36-37.
- Norell, M. A. and Novacek, M. J. (1992) "Congruence between superpositional and phylogenetic patterns: Comparing cladistic patterns with fossil records." *Cladistics* 8: 319-337.
- Norell, M. A. and Novacek, M. J. (1992b) "The fossil record and evolution: Comparing cladistic and paleontologic evidence for vertebrate history." *Science* 255: 1690-93.
- Norris, J. R. (1997) **Markov Chains**. Cambridge, Cambridge University Press.
- Novick, G. E., Gonzalez, T., Garrison, J., Novick, C. C., Batzer, M. A., Deininger, P. L., Herrera, R. J. (1993) "The use of polymorphic Alu insertions in human DNA fingerprinting." *EXS*. 67: 283-291.
- Novick, G. E., Novick, C. C., Yunis, J., Yunis, E., Martinez, K., Duncan, G. G., Troup, G. M., Deininger, P. L., Stoneking, M., Batzer, M. A., et al. (1995) "Polymorphic human specific Alu insertions as markers for human identification." *Electrophoresis* 16: 1596-1601.
- Obiechina, A. E., Arotiba, J. T., and Fasola, A. O. (2001) "Third molar impaction: evaluation of the symptoms and pattern of impaction of mandibular third molar teeth in Nigerians." *Odontostomatol Trop*. 24: 22-25. [[PubMed](#)]
- Ochman, H., Lawrence, J. G., Groisman, E. A. (2000) "Lateral gene transfer and the nature of bacterial innovation." *Nature* 405: 299-304.
- Oetting, W. S., O. C. Stine, et al. (1993) "Evolution of the tyrosinase related gene (TYRL) in primates." *Pigment Cell Research* 6: 171-177.
- Ogawa, R. and Kamiya, T. A. (1957) "Case of the cachalot with protruded rudimentary hind limbs." *Sci. Rep. Whales Res. Inst.* No. 12.
- Ohno, S. (1984) "Birth of a unique enzyme from an alternative reading frame of the preexisted, internally repetitious coding sequence." *PNAS* 81: 2421-5.
- Ohta, T. (1993) "An examination of the generation-time effect on molecular evolution." *PNAS* 90: 10676-10680.
- Ohta, Y. and Nishikimi, M. (1999) "Random nucleotide substitutions in primate nonfunctional gene for L-gulano-gamma-lactone oxidase, the missing enzyme in L-ascorbic acid biosynthesis." *Biochimica et Biophysica Acta* 1472: 408-411.
- Okada, H., Negoro, S., Kimura, H., and Nakamura, S. (1983) "Evolutionary adaptation of plasmid-encoded enzymes for degrading nylon oligomers." *Nature* 306: 203-6.
- Orser, C. S. and Lange, C. C. (1994) "Molecular analysis of pentachlorophenol degradation." *Biodegradation* 5: 277-288.
- Osborn, H. F. (1918) **The Origin and Evolution of Life**. Charles Scribner's Sons, New York.

- Ostertag, E. M. and Kazazian, H. H. (2001) "Biology of mammalian L1 retrotransposons." *Annu. Rev. Genet.* 35: 501-538.
- Ostrom, J. H. (1973) "The ancestry of birds." *Nature* 242: 136.
- Ou, C. Y., Ciesielski, C. A., Myers, G., Bandea, C. I., Luo, C. C., Korber, B. T., Mullins, J. I., Schochetman, G., Berkelman, R. L., Economou, A. N. and et al. (1992) "Molecular epidemiology of HIV transmission in a dental practice." *Science* 256: 1165-71.
- Patterson, C., Williams, D., and Humphries, C. (1993) "Congruence between molecular and morphological phylogenies." *Annual Review of Ecology and Systematics* 24: 153-188.
- Pei, M. (1949) **The Story of Language**. Philadelphia, Lippincott.
- Penny, D. and Hendy, M. D. (1986) "Estimating the reliability of phylogenetic trees." *Mol. Biol. Evol.* 3: 403-417.
- Penny, D., Foulds, L. R., and Hendy, M. D. (1982) "Testing the theory of evolution by comparing phylogenetic trees constructed from five different protein sequences." *Nature* 297: 197-200.
- Penny, D., Hendy, M. D., and Steel, M. A. (1991) "Testing the theory of descent." In **Phylogenetic Analysis of DNA Sequences**, eds. Miyamoto, M. and Cracraft, J., Oxford University Press, New York. pp. 155-183.
- Piccirilli, J. A., T. S. McConnell, et al. (1992) "Aminoacyl esterase activity of the Tetrahymena ribozyme." *Science* 256: 1420-1424.
- Popper, K. R. (1968) **The Logic of Scientific Discovery**. London, Hutchinson.
- Prager, E. M. and Wilson, A. C. (1988) "Ancient origin of lactalbumin from lysozyme: analysis of DNA and amino acid sequences." *Journal of Molecular Evolution* 27: 326-335.
- Prijambada, I. D., Negoro, S., Yomo, T., Urabe, I. (1995) "Emergence of nylon oligomer degradation enzymes in *Pseudomonas aeruginosa* PAO through experimental evolution." *Appl Environ Microbiol.* 61: 2020-2022.
- Prinos, P., Joseph, S., Oh, K., Meyer, B. I., Gruss, P., and Lohnes, D. (2001) "Multiple pathways governing Cdx1 expression during murine development." *Dev Biol* 239: 257-269. [\[PubMed\]](#)
- Ptitsyn, O. B. (1998) "Protein folding and protein evolution: common folding nucleus in different subfamilies of c-type cytochromes." *Journal of Molecular Biology* 278: 655.
- Qasba, P. K. and Kumar, S. (1997) "Molecular divergence of lysozymes and alpha lactalbumin." *Critical Review of Biochemistry and Molecular Biology* 32: 255-306.
- Qiang, J., P. J. Currie, et al. (1998) "Two feathered dinosaurs from northeastern China." *Nature* 393: 753-761.

Rakprasitkul, S. (2001) "Pathologic changes in the pericoronal tissues of unerupted third molars." *Quintessence Int.* 32: 633-638. [\[PubMed\]](#)

Rasoloarison, R. M., Goodman, S. M., and Ganzhorn, J. U. (2000) "Taxonomic revision of mouse lemurs (*Microcebus*) in the western portions of Madagascar." *International Journal of Primatology.* 21(6): 963-1019.

Raymond, M., Berticat, C., Weill, M., Pasteur, N., Chevillon, C. (2001) "Insecticide resistance in the mosquito *Culex pipiens*: what have we learned about adaptation?" *Genetica* 112-113:287-296.

Raynaud, A. (1990) "Developmental mechanism involved in the embryonic reduction of limbs in reptiles." *Int J Dev Biol* 34:233-243. [\[PubMed\]](#)

Raynaud, A., and Kan, P. (1992) "DNA synthesis decline involved in the developmental arrest of the limb buds in the embryos of the slow worm, *Anguis fragilis* (L.)." *Int J Dev Biol* 36:303-310. [\[PubMed\]](#)

Reeve, H. K. and Sherman, P. W. (1993) "Adaptation and the goals of evolutionary success." *Quarterly Review of Biology* 68: 1-32.

ReMine, W. and J. M. K. (anonymous) (1982) "Child recently born with a tail?" *Bible Science Newsletter* 20: 8.

Reznick, D. N. (1997) "Evaluation of the rate of evolution in natural populations of guppies (*Poecilia reticulata*)" *Science* 275: 1934-1937.

Rhodes, F. H. T. (1983) "Gradualism, punctuated equilibria, and the origin of species." *Nature* 305: 269-272.

Richter, T. E. and Ronald, P. C. (2000) "The evolution of disease resistance genes." *Plant Molecular Biology* 42: 195-204.

Ridley, M. (1993) **Evolution**. Boston: Blackwell Scientific.

Ridley, M., Ed. (1997) **Evolution**. Oxford, Oxford University Press.

Rightmire, G. P. (1985) "The tempo of change in the evolution of mid-Pleistocene Homo." In **Ancestors: the Hard Evidence**. E. Delson. New York, Alan R. Liss: pp. 255-264.

Ringe, D., (1999) "Language classification: scientific and unscientific methods." in **The Human Inheritance**, ed. B. Sykes. Oxford: Oxford University Press, 45-74.

Roelink, H., Wang, J., Black, D. M., Solomon, E., and Nusse, R. (1993) "Molecular cloning and chromosomal localization to 17q21 of the human WNT3 gene." *Genomics* 17: 790-792. [\[PubMed\]](#)

Roth, V. L. (1984) "On homology." *Biological Journal of the Linnean Society* 22: 13-29.

Rouquier, S., A. Blancher, et al. (2000) "The olfactory receptor gene repertoire in primates and mouse: Evidence for reduction of the functional fraction in primates." *PNAS* 97: 2870-2874.



- Roy-Engel, A. M., Carroll, M. L., Vogel, E., Garber, R. K., Nguyen, S. V., Salem, A. H., Batzer, M. A., and Deininger, P. L. (2001) "Alu insertion polymorphisms for the study of human genomic diversity." *Genetics* 159: 279-290.
- Rozenski, J., P. F. Crain, et al. (1999) "The RNA Modification Database: 1999 update." *Nucleic Acids Research* 27: 196-197. <http://medlib.med.utah.edu/RNAmods/>
- Rubin, G. M. et al. (2000) "Comparative Genomics of the Eukaryotes." *Science* 287: 2204-2218.
- Salamone, P. R., Kavakli, I. H., Slattery, C. J., Okita, T. W. (2002) "Directed molecular evolution of ADP-glucose pyrophosphorylase." *Proc Natl Acad Sci* 99: 1070-1075.
- Salmon, W. (1990) "Rationality and Objectivity in Science, or Tom Kuhn meets Tom Bayes." In **Scientific Theories**. C. W. Savage. Minneapolis, University of Minnesota Press. 14.
- Sapunar, D., Vilovic, K., England, M., and Saraga-Babic, M. (2001) "Morphological diversity of dying cells during regression of the human tail." *Ann Anat* 183: 217-222. [\[PubMed\]](#)
- Saraga-Babic, M., Lehtonen, E., Svajger, A., and Wartiovaara, J. (1994) "Morphological and immunohistochemical characteristics of axial structures in the transitory human tail." *Anat Anz.* 176: 277-286. [\[PubMed\]](#)
- Saraga-Babic, M., Stefanovic, V., Saraga, M., Wartiovaara, J., and Lehtonen, E. (2002) "Expression of intermediate filaments and desmosomal proteins during differentiation of the human spinal cord." *Acta Histochem.* 104: 157-166. [\[PubMed\]](#)
- Sawada, I., C. Willard, et al. (1985) "Evolution of Alu family repeats since the divergence of human and chimpanzee." *Journal of Molecular Evolution* 22: 316.
- Scadding, S. R. (1981) "Do 'vestigial organs' provide evidence of evolution?" *Evolutionary Theory* 5: 173-176.
- Scarpulla, R. C. and Nye, S. H. (1986) "Functional expression of rat cytochrome *c* in *Saccharomyces cerevisiae*." *Proc Natl Acad Sci* 83: 6352-6.
- Schersten, E., Lysell, L., and Rohlin, M. (1989) "Prevalence of impacted third molars in dental students." *Swed Dent J.* 13: 7-13. [\[PubMed\]](#)
- Schmid, K. J. and Tautz, D. (1997) "A screen for fast evolving genes from *Drosophila*." *Proc. Natl. Acad. Sci. USA.* 94: 9746-9750.
- Schubert, M., Holland, L. Z., Stokes, M. D., and Holland, N. D. (2001) "Three amphioxus Wnt genes (AmphiWnt3, AmphiWnt5, and AmphiWnt6) associated with the tail bud: the evolution of somitogenesis in chordates." *Dev Biol* 240: 262-273. [\[PubMed\]](#)
- Sedmera, D., Misek, I., and Klima, M. (1997) "On the development of Cetacean extremities: I. Hind limb rudimentation in the Spotted dolphin (*Stenella attenuata*)." *Eur J Morphol* 35: 25-30. [\[PubMed\]](#)

Sereno, P. C. (1999) "The Evolution of Dinosaurs." *Science* 284: 2137-2147.

Shimamura, M., et al. (1997) "Molecular evidence from retroposons that whales form a clade within even-toed ungulates." *Nature* 388: 666.

Shum, A. S., Poon, L. L., Tang, W. W., Koide, T., Chan, B. W., Leung, Y. C., Shiroishi, T., and Copp, A. J. (1999) "Retinoic acid induces down-regulation of Wnt-3a, apoptosis and diversion of tail bud cells to a neural fate in the mouse embryo." *Mech Dev* 84: 17-30. [\[PubMed\]](#)

Sleptsov, M. M. (1939) "On the asymmetry of the skull of *Odontoceti*." *Zoologicheskii Zhurnal* 18: 3.

Smit, A. F. A. (1996) "The origin of interspersed repeats in the human genome." *Current Opinion in Genetics and Development* 6: 743-748.

Smith, J. M. (1993) **The Theory of Evolution**. Cambridge, Cambridge University Press.

Spiegelmann, R. Schinder, E. Mintz, M., and Blakstein., A. (1985) "The human tail: a benign stigma." *J. Neurosurgery* 63:461-462.

Standfast, A. L. (1992) "The human tail." *New York State Journal of Medicine*. 92: 116.

Stanley, S. (1993) **Earth and Life Through Time**. New York, W. H. Freeman.

Steel, M. A. and Penny., D. (1993) "Distributions of tree comparison metrics - some new results." *Systematic Biology* 42: 126-141.

Stewart, C. B. and Disotell, T. R. (1998) "Primate evolution - in and out of Africa." *Current Biology* 8: R582-588.

Strait, D. S., Grine, F. E., and Moniz, M. A. (1997) "A reappraisal of early hominid phylogeny." *J Hum Evol* 32: 17-82.

Sugumata, A., Sato, M., Ikeda, J., Kinoshita, J., Tanihira, S., and Makimo, K. (1988) "Two cases of a true human tail." *Jpn J Plast Reconstr Surg* 31: 1072.

Svensson, A. C., N. Setterblad, et al. (1995) "Primate DRB genes from the DR3 and DR8 haplotypes contain ERV9 LTR elements at identical positions." *Immunogenetics* 41: 74.

Sverdlov, E. D. (2000) "Retroviruses and primate evolution." *BioEssays* 22: 161-171.

Swofford, D. L., Olsen, G. J., Waddell, P. J., and Hillis, D. M. (1996) "Phylogenetic inference." In **Molecular Systematics**, pp 407-514. Hillis, D. M., Moritz, C. and Mable, B. K. eds., Sinauer, Sunderland, Massachusetts.

Takada, S., Stark, K. L., Shea, M. J., Vassileva, G., McMahon, J. A., and McMahon, A. P. (1994) "Wnt-3a regulates somite and tailbud formation in the mouse embryo." *Genes Dev* 8: 174-189. [\[PubMed\]](#)

- Tanaka, Y., Ashikari, T., Shibano, Y., Amachi, T., Yoshizumi, H., and Matsubara, H. (1988a) "Amino acid replacement studies of human cytochrome *c* by a complementation system using CYC1 deficient yeast." *J Biochem (Tokyo) Sep*;104: 477-80.
- Tanaka, Y., Ashikari, T., Shibano, Y., Amachi, T., Yoshizumi, H., and Matsubara, H. (1988b) "Construction of a human cytochrome *c* gene and its functional expression in *Saccharomyces cerevisiae*." *J Biochem (Tokyo)* 103: 954-61.
- Tarrusova, N. B., G. M. Jacovleva, et al. (1981) "Synthesis of an unnatural P-N bond catalyzed with *Escherichia coli* ribosomes." *FEBS Letters* 130: 85-87.
- Tevepaugh, D. B., and Dodson, T. B. (1995) "Are mandibular third molars a risk factor for angle fractures? A retrospective cohort study." *J Oral Maxillofac Surg.* 53: 646-649. [[PubMed](#)]
- Thalmann, U. and Geissmann, T. (2000) "Distribution and geographic variation in the western woolly lemur (*Avahi occidentalis*) with description of a new species (*A. unicolor*)" *International Journal of Primatology.* 21 (6): 915-941.
- Thewissen, J. G., Williams, E. M., Roe, L. J., and Hussain, S. T. (2001) "Skeletons of terrestrial cetaceans and the relationship of whales to artiodactyls." *Nature.* 413: 277-281. [[PubMed](#)]
- Thornhill, R. H. and Ussery, D. W. (2000) "A classification of possible routes of Darwinian evolution." *Journal of Theoretical Biology* 203: 111-116.
- Todaro, G.J., Benveniste, R.E., Callahan, R., Lieber, M.M., and Sherr, C.J. (1975) "Endogenous primate and feline type C viruses." *Cold Spring Harb Symp Quant Biol.* 39 Pt 2:1159-1168. [[PubMed](#)]
- Tyndale-Biscoe, H. and Renfree, M. (1987) **Reproductive Physiology of Marsupials.** Cambridge University Press.
- Unrau, P. D. and Bartel, D. P. (1998) "RNA-catalyzed nucleotide synthesis." *Nature* 395: 260-263.
- Urnovitz, H. B. and Murphy, W. H. (1996) "Human endogenous retroviruses: nature, occurrence, and clinical implications in human disease." *Clin Microbiol Rev* 9: 72-99.
- van Roosmalen, M. G.M., van Roosmalen, T., Mittermeier, R. A. and Rylands, A. B. (2000) "Two new species of marmoset, genus *Callithrix Erxleben, 1777 (Callitrichidae, Primates)*, from the Tapajos/Madeira interfluvium, south central Amazonia." *Neotropical Primates* 8(1): 2-18.
- Veenstra, J., Schuurman, R., Cornelissen, M., van't Wout, A. B., Boucher, C. A., Schuitemaker, H., Goudsmit, J. and Coutinho, R. A. (1995) "Transmission of zidovudine-resistant human immunodeficiency virus type 1 variants following deliberate injection of blood from a patient with AIDS: characteristics and natural history of the virus." *Clin Infect Dis* 21: 556-60.
- Voet, D. and Voet, J. (1995) **Biochemistry.** New York, John Wiley and Sons.

Vogel, G. (1997) "Phylogenetic analysis: getting its day in court." *Science* 275: 1559-60.

von Ahsen, U. and Noller, H. F. (1995) "Antibiotic inhibition of group I ribozyme function." *Nature* 353: 368-370.

von Fraassen, B. C. (1980) **The Scientific Image**. Oxford, Clarendon Press.

Wadsworth, H. M. (1997) **Handbook of statistical methods for engineers and scientists**. New York: McGraw-Hill Pub. Co.

Wallace, C. J. and Tanaka, Y. (1994) "Improving cytochrome *c* function by protein engineering?: studies of site-directed mutants of the human protein." *J. Biochem. (Tokyo)* 115: 693-700.

Wallace, M. R., L. B. Andersen, et al. (1991) "A *de novo* Alu insertion results in neurofibromatosis type 1." *Nature* 353: 864-866.

Wang, Y. Hu, Y., Meng, J. and Li., C. (2001) "An ossified meckel's cartilage in two Cretaceous mammals and origin of the mammalian middle ear." *Science* 294: 357-361.

White III, H. B. (1976) "Coenzymes as fossils of an earlier metabolic state." *Journal of Molecular Evolution* 7: 101-104.

Widdowson, C. A., Adrian, P. V., Klugman, K. P. (2000) "Acquisition of chloramphenicol resistance by the linearization and integration of the entire staphylococcal plasmid pC194 into the chromosome of *Streptococcus pneumoniae*." *Antimicrob Agents Chemother* 44: 393-95.

Wiedersheim, R. (1893) **The Structure of Man**. Second Edition. Translated by H. and M. Bernard. London: Macmillan and Co. 1895.

Williams, G. C. (1992) **Natural Selection: Domains, Levels, and Challenges**. New York, Oxford University Press.

Wills, M. A. (1999) "The gap excess ratio, randomization tests, and the goodness of fit of trees to stratigraphy." *Syst. Biol.* 48: 559-580.

Wilson, E. O. (1992) **The Diversity of Life**. Cambridge, MA, Harvard University Press.

Wise, K. P. (1994) "The Origin of Life's Major Groups." In **The Creation Hypothesis**, pp. 211-234. Moreland, J. P. ed., InterVarsity Press, Downers Grove, IL.

Woese, C. (1967) **The Genetic Code: The Molecular Basis for Genetic Expression**. New York, Harper and Row: 179-195.

Woese, C. (1998) "The universal ancestor." *PNAS* 95: 6854-6859.

Woodburne, M. O. and Case, J. A. (1996) "Dispersal, vicariance, and the Late Cretaceous to Early Tertiary land mammal biogeography from South America to Australia." *Journal of Mammalian Evolution* 3: 121-161.

Wright, L. (1973) "Functions." *Philosophical Review* 82: 139- 168.

Wu, C. I. (1991) "Inferences of species phylogeny in relation to segregation of ancient polymorphisms." *Genetics* 127: 429-435. [[PubMed](#)]

Xu, X., Tang, Z-T., Wang, X-l. (1999) "A therizinosauroid dinosaur with integumentary structures from China." *Nature* 399: 350-354.

Xu, X., Zhou, Z., and Wang ,X. (2002) "The smallest known non-avian theropod dinosaur." *Nature* 408: 705-708.

Xu, X., Norell, M. A., Wang, X-l., Makovicky, P. J., and Wu, X.C. (2002) "A basal troodontid from the Early Cretaceous of China." *Nature* 415: 780-784.

Yirrell, D. L., Robertson, P., Goldberg, D. J., McMenamin, J., Cameron, S. and Leigh Brown, A. J. (1997) "Molecular investigation into outbreak of HIV in a Scottish prison." *Bmj* 314: 1446-50.

Yockey, H. P. (1992) **Information Theory and Molecular Biology**. New York, Cambridge University Press.

Yoder, A. D., Rasoloarison, R. M., Goodman, S. M., Irwin, J. A., Atsalis, S., Ravosa, M. J., and Ganzhorn, J. U. (2000) "Remarkable species diversity in Malagasy mouse lemurs (primates, *Microcebus*)" *Proc Natl Acad Sci* 97(21): 11325-30.

Zembskii, V. A. and Berzin, A. A. (1961) "On the rare phenomenon of atavism in the sperm whale." *Nauchnye Doklady Vysshei Shkoly. Series "Biologicheskije Nauki."*

Zhu, T., B. Korber, et al. (1998) "An African HIV-1 sequence from 1959 and implications for the origin of the epidemic." *Nature* 391: 594- 597.



[Contents](#)

Home	Browse	Search	Feedback	Links
The FAQ		Must-Read Files		Index
Evolution		Creationism		Age of the Earth
Flood Geology		Catastrophism		Debates

[Home Page](#) | [Browse](#) | [Search](#) | [Feedback](#) | [Links](#)



[The FAQ](#) | [Must-Read Files](#) | [Index](#) | [Creationism](#) | [Evolution](#) | [Age of the Earth](#) | [Flood Geology](#) | [Catastrophism](#) | [Debates](#)

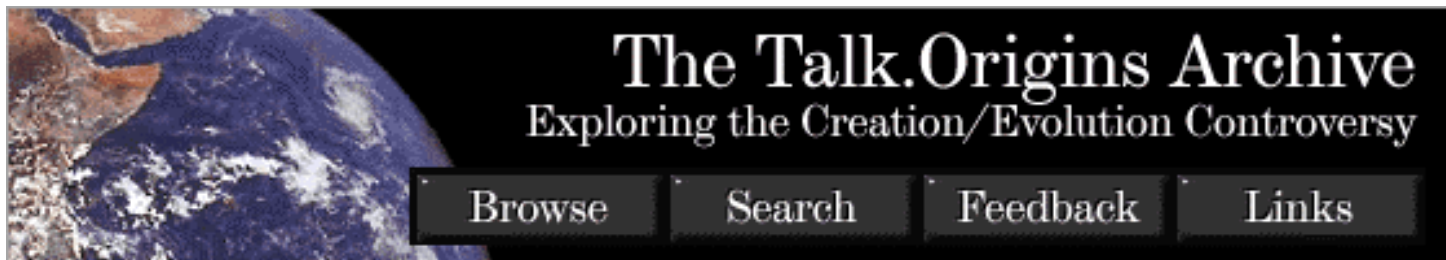

## 29+ Evidences for Macroevolution

### Glossary

Copyright © 1999-2003 by [Douglas Theobald, Ph.D.](#)

---



[Contents](#)

**abiogenesis** Not to be confused with "spontaneous generation," it is the theory that life originally arose from non-living matter, given the proper conditions during the early earth.

**analogy** The case of similar function despite different structures; the opposite of *parahomology*. Similar to the evolutionary concept of [convergence](#).

**character** A feature or trait of an organism. Characters have a specific structure and function.

**cladistics** A method for constructing phylogenies based on shared derived characters of species, originally rigorously detailed by Willi Hennig in 1950.

**convergence** Convergence is an amorphous evolutionary term that is used in somewhat different senses by different authors (or even by the same people at different times). It generally refers to similarities between organisms that evolved independently, i.e. similarities not directly inherited from a common ancestor. Convergent similarities can involve structure, form, and function. Strict convergence of both function and structure is very rare, except in trivial cases. Convergence of form and function is common, and is a direct prediction of the theory of natural selection. In a sense, convergence is the opposite of [homology](#).

**derived characters** Among a given group of organisms, the shared derived characters are generally the less common characters. The evolutionary interpretation is that these characters of organisms are more recently evolved. They are contrasted with *primitive characters*. Shared derived characters should have the same structure and function.

**function** The function concept is complex. Functions are not simply anything that appears "useful"; this is a subjective teleological notion. An objective definition of function is any identifiable process performed by a biological entity that is necessary for the successful reproduction of that entity. A function of a certain structure is a particular consequence of that structure responsible for that structure's continued existence in terms of reproductive success. Functions are relative; some similar structures function better than others. If structure A results in better reproductive success than another similar structure B, then structure A is more functional than B. Thus, function depends on context; gills have no function on land and lungs do not function underwater. Also, sometimes it is necessary to infer the function of a character based on its form (e.g. pterodactyl wings were used for flight) ([Wright 1973](#); [Cummins 1975](#); [Millikan 1989](#); [Reeve and Sherman 1993](#)). In general the functionality of a given structure can be experimentally measured and quantified (a common practice in genetics).

**homology** In this essay, since we are not assuming the truth of common descent, "homology" simply refers to similar structures, regardless of function. In evolutionary biology, structures are homologous only if they were derived from the same structure in a common ancestor. "Homology" in evolutionary practice is thus a hypothesis which can be tested, and which can garner various levels of evidential support (primarily taking into account all available phylogenetic evidence). Importantly, there exist multiple levels of homology in biology. What is evolutionarily homologous at one level may not be so at a lower level or at a higher level ([Dickinson 1995](#)). The causal chain in biology is discontinuous, including genes, genetic networks and pathways, cells, cell types, developmental pathways, organs, and organisms. Though each level is dependent upon the preceding level, functions at one level can be redundant (due to the stochastic and opportunistic nature of evolution), and thus functions are occasionally free to shift, resulting in uncoupling between levels of homology. This fact has caused some confusion in practice for the precise application and delineation of the homology concept. For example, the *genes* which control the development of eyes are homologous between vertebrates and invertebrates, yet the *organs* (the eyes themselves) are not (i.e. they evolved convergently into very different structures having somewhat similar functions). Also see [parahomology](#), [analogy](#), and [convergence](#).

**intermediate form** A fossil or modern species that displays characters definitive of two or more different taxa or that displays characters morphologically intermediate between two different taxa. The existence of intermediate forms is a prediction of common descent. An intermediate is not necessarily a common ancestor or even an actual ancestor of a modern species. For example, the intermediate species *Archaeopteryx* displays

characters definitive of two different taxa (e.g. dromaeosaur dinosaurs and birds), yet *Archaeopteryx* is probably not an ancestor of modern birds.

**macroevolution** Evolution on the grand scale resulting in the origin of higher taxa. In evolutionary theory it thus entails common ancestry, descent with modification, the genealogical relatedness of all life, transformation of species, large scale functional and structural changes, etc.

**microevolution** Change within species; relatively minor change in the composition of a species' gene pool with time.

**ontogeny** The development of an individual organism, especially the process studied in the science of embryology.

**parahomology** In non-evolutionary terms, similarity of structure despite difference of function; the opposite of *analogy*. The proper evolutionary interpretation of parahomology would refer to only homologous characters (at a specified biological level) which had diverged in function. **Nota Bene:** In this essay, I use the nonstandard term "parahomology"; it is a term I invented. This is necessary for two reasons. First, the standard homology argument for evolution is primarily based upon structures that are similar between organisms but have different functions. In contrast, the evolutionary concept of homology includes all corresponding structures inherited from a common ancestor, regardless of whether they have the same or different functions. To clarify the homology argument, then, a new and specific term is needed that refers to the subset of homologous structures that have different functions. Second, the standard homology argument can be criticized as being circular. Now that common descent is accepted as scientific fact, it is only logical to redefine homology in terms of common descent, as opposed to the original definition of homology that had no evolutionary basis. Modern evolutionary biologists define homology in this way (even though they use independent methods to infer homology). Thus it is fallacious to use the redefined evolutionary homology concept as evidence for common descent. In contrast, the parahomology concept, as used here, is defined independent of common descent and can be recognized in organisms regardless of whether one accepts evolutionary theory or not. Of course one could define homology similarly, but using a different term avoids the confusion of multiple definitions.

**phenotype** The morphological, physiological, biochemical, behavioral, and other properties of an organism, manifested throughout its life.

**phylogeny** A genealogy of species; the history of descent of taxa from common ancestors, including the relative times at which species branched or diverged from each other.

**primitive characters** Contrasting with *derived characters*, they are the more common



shared characters of a given group of organisms. Like derived characters, they also have the same structure and function. The evolutionary interpretation is that these characters evolved earlier than derived characters.

**species** As usually used within this article, a species is a reproductively isolated group of organisms capable of interbreeding in the wild and producing viable, fertile offspring. This is known as the Biological Species Concept (BSC). An alternative statement of the BSC defines a species as the most inclusive group of sexual and cross-fertilizing individuals which share a common gene pool. However, this concept breaks down for asexual species, fossil species, and even sexual species in many cases. In reality there are only degrees of reproductive and genetic isolation, so species are not absolute entities. Joseph Boxhorn has given a more detailed [analysis of the species concept](#) in the "[Observed Instances of Speciation](#)" FAQ. Note, the BSC has interesting implications for the nature of the last universal common ancestor of all life, especially if horizontal genetic transfer was extensive then (as it is today between the different unicellular "species" of bacteria, archaea, and eukaryotes).

**structure** Relative position and shape of an organism's various parts; the pattern underlying its form. Similar structures have similar positions and shapes of parts; however, relative size can vary considerably. Should not be confused with "form." A bat and insect wing both have similar forms (e.g. they are both elongated and flat and can be flapped), but they have very different underlying structures.

**transitional form** See [intermediate form](#).

**vestigial characters** A vestigial character is reduced and rudimentary compared to the same complex structure in other organisms. Vestigial characters, if functional, perform relatively simple, minor, or inessential functions using structures that were clearly designed for other complex purposes. The most extreme test for vestigiality is to remove the character and observe the organism's viability and reproductive success. If these remain unchanged, the character is definitively vestigial. However, vestigial characters can certainly have functions; non-functionality is not a requirement.



## References

Cummins, R. (1975) "Functional Analysis." *Journal of Philosophy* 72: 741-765.

Dickinson, W. J. (1995) "Molecules and morphology: where's the homology?" Trends Genet. 11: 119-121. [\[PubMed\]](#)

Millikan, R. (1989) "In defence of proper functions." Philosophy of Science 56: 288-302.

Reeve, H. K. and Sherman, P. W. (1993) "Adaptation and the goals of evolutionary success." Quarterly Review of Biology 68: 1-32.

Wright, L. (1973) "Functions." Philosophical Review 82: 139- 168.

[Full references](#)

[Glossary](#)

  
[Contents](#)

Home	Browse	Search	Feedback	Links
The FAQ		Must-Read Files		Index
Evolution		Creationism		Age of the Earth
Flood Geology		Catastrophism		Debates

[Home Page](#) | [Browse](#) | [Search](#) | [Feedback](#) | [Links](#)



[The FAQ](#) | [Must-Read Files](#) | [Index](#) | [Creationism](#) | [Evolution](#) | [Age of the Earth](#) | [Flood Geology](#) | [Catastrophism](#) | [Debates](#)